

Dec.1.2019 Copyright 2019 HIROSE ELECTRIC CO., LTD. All Rights Reserved.
 In case of consideration for using Automotive equipment / device which demand high reliability, kindly contact our sales window correspondents.

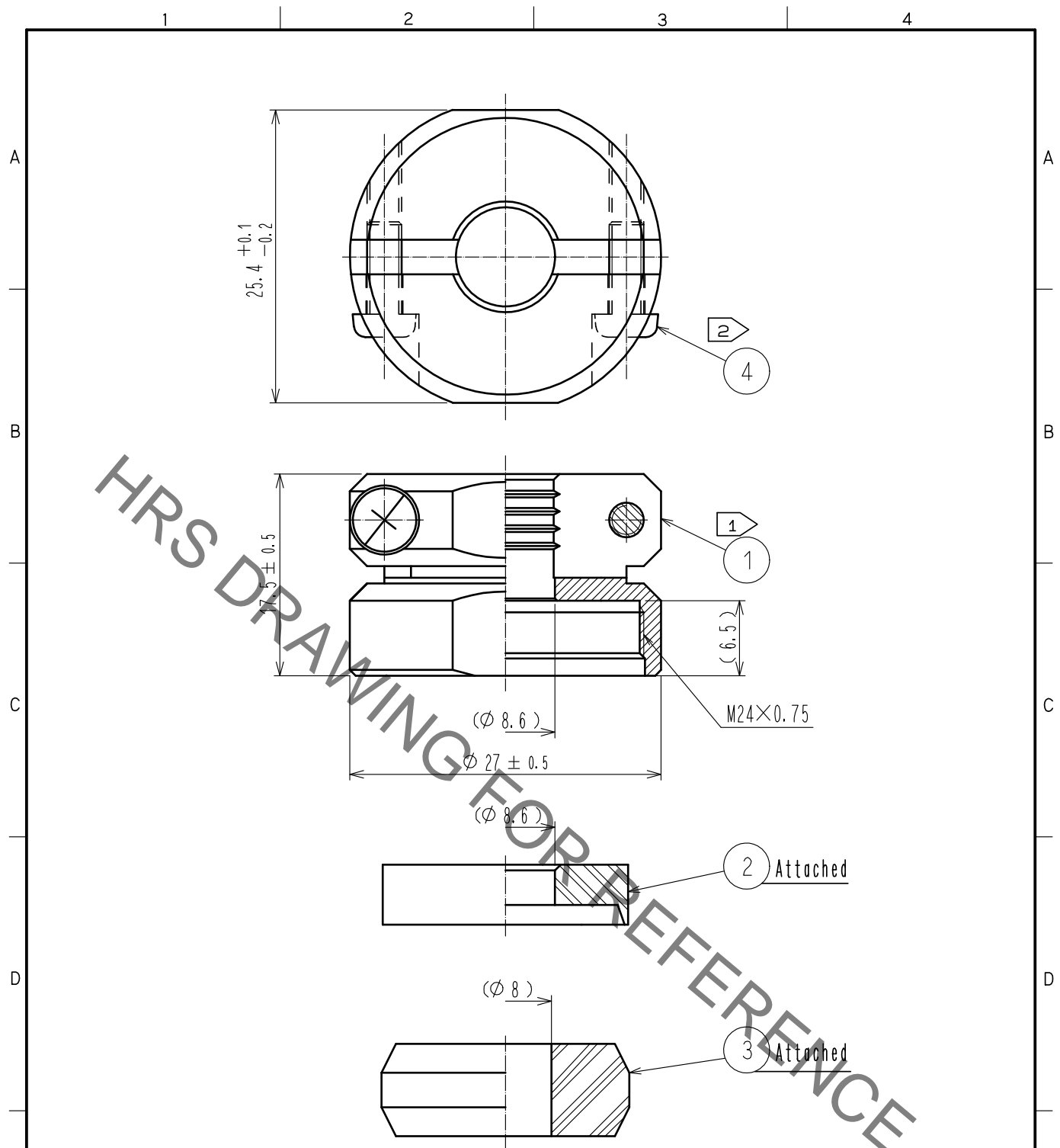

- Notes
- ① The recommended clamp torque of ref. No. ① : 4 to 4.5 N·m .
 LOCTITE 263, HENKEL JAPAN or equevalent is recommended to prevent ref. No. ① from loosening.
 - ② The recommended clamp torque of ref. No. ④ to be 0.65 to 0.7 N·m .
 - 3. The cable pull and twisting strength, waterproof tightness and other characteristics may differ, depending on the cable structure. Please confirm before the use.

2	PPS	(Black) UL94V-0	4	Stainless steel	M3×0.5×8
1	Brass	Black chrome plating	3	Acrylonitrile butadiene rubber	(Grey)
NO.	MATERIAL	FINISH . REMARKS	NO.	MATERIAL	FINISH . REMARKS

UNITS mm		SCALE 2 : 1	COUNT 	DESCRIPTION OF REVISIONS	DESIGNED	CHECKED	DATE
HIROSE ELECTRIC CO., LTD.				APPROVED :HY. KOBAYASHI 18.02.26 CHECKED :HY. KOBAYASHI 18.02.26 DESIGNED :TH. KAMEYA 18.02.23 DRAWN :MK. INOUE 18.02.14	DRAWING NO. EDC-110609-31-00 PART NO. JR21WCC-8(31) CODE NO. CL114-2058-2-31		