

CTH SERIES METALIZED PLASTIC “D” SUBMINIATURE SHELL

General

The HIROSE "CTH" plug cases are made of plated plastic for achieve high shielding effectiveness. 9, 15, 25 and 37-contact models are available. Suitable for

protecting the interfaces between units from electro-magnetic interference.

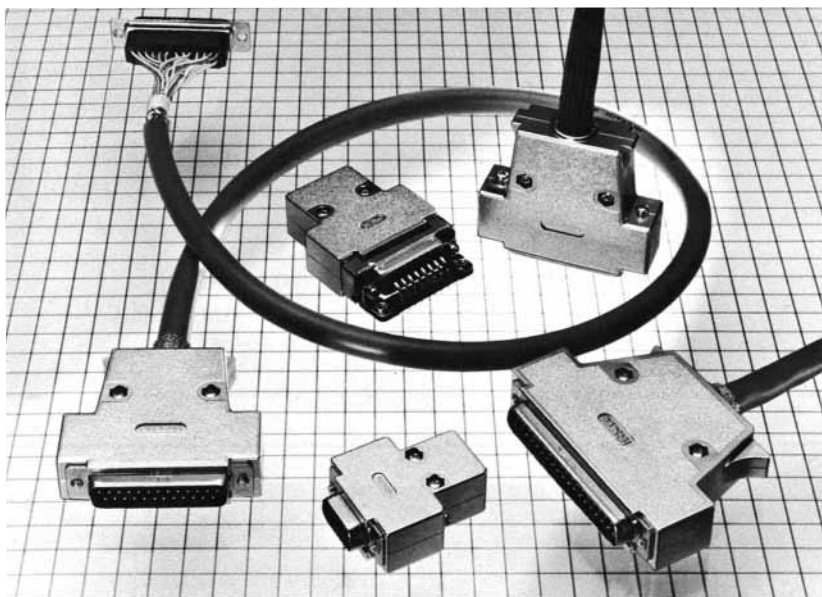

Features

- (1) Standard screw type locking mechanism provides a strong and secure lock.
- (2) Plated ABS resin enable shell to be lightweight and strong with excellent shielding characteristics (ABS resin UL94HB/plating UL746C)
- (3) Enhanced shielding effectiveness by clamping the cable shielding part with two types of clamps sandwiched between the plug cases.
- (4) The clamp has a screw to ground the drain wire. Can easily in corporate soldering (HD), ribbon cable type (FD) and crimping (CD).

Applications

Computers, peripherals and terminals, control equipment, and measuring instruments.

Material and Finish

Parts	Materials	Finish
Plug Case	ABS	Chrome plated over nickel plated

Ordering Informations

Plug Case

H D
B
-
C T
H
1
(4-40)
(10)

(1) (2) (3) (4) (5) (6)

- (1) Series Name
- (2) Connector size: E (9 contacts), A (15 contacts), B (25 contacts), C (37 contacts)
 Note: Not available for 50pos. cover.
- (3) Type of plug case
 CT: With vertical cable inlet opening
- (4) Serial sign for series
 H: Plug case made of plated plastic
- (5) No sign: Lock screw to be driven with screwdriver
 1: Hand-driven lock screw
- (6) No sign: M2.6
 (4-40): Inch



HDE-CTH (10)

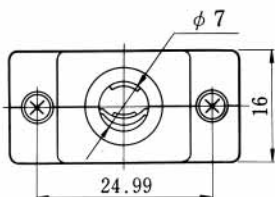

HRS No	Part No.	RoHS
CL211-0276-1-10	HDE-CTH (10)	YES
CL211-0309-9-10	HDE-CTH (4-40) (10)	
CL211-0621-8-10	HDE-CTH1 (10)	
CL211-0865-2-10	HDE-CTH1 (4-40) (10)	

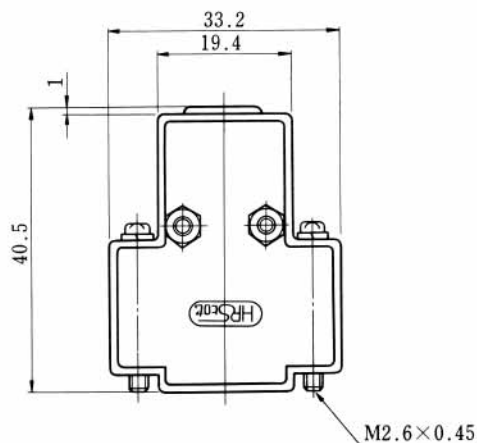



HDA-CTH (10)

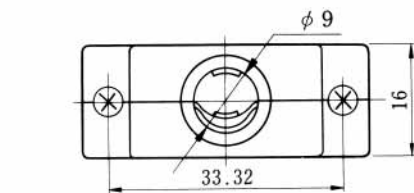

HRS No	Part No.	RoHS
CL211-0277-4-10	HDA-CTH (10)	YES
CL211-0346-5-10	HDA-CTH (4-40) (10)	
CL211-0622-0-10	HDA-CTH1 (10)	
CL211-0882-1-10	HDA-CTH1 (4-40) (10)	

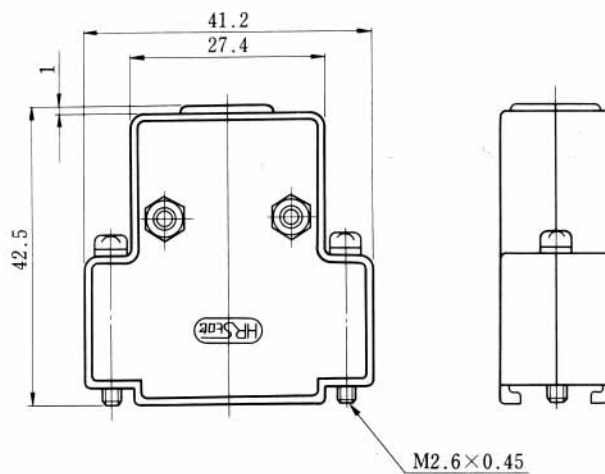

HDB-CTH (10)

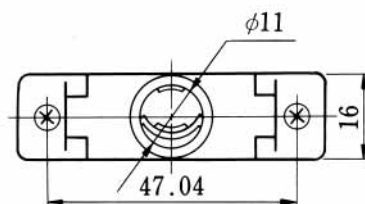

HRS No	Part No.	RoHS
CL211-0278-7-10	HDB-CTH (10)	YES
CL211-0347-8-10	HDB-CTH (4-40) (10)	
CL211-0306-0-10	HDB-CTH1 (10)	
CL211-0532-0-10	HDB-CTH1 (4-40) (10)	

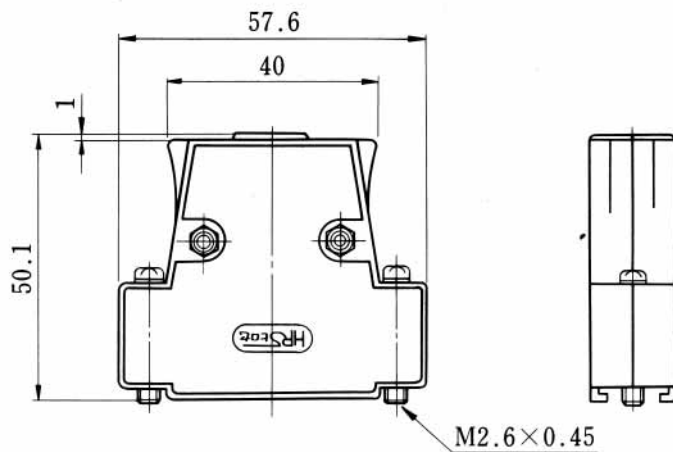

Mar.1.2024 Copyright 2024 HIROSE ELECTRIC CO., LTD. All Rights Reserved.
 Nov.1.2016 Copyright 2016 HIROSE ELECTRIC CO., LTD. All Rights Reserved.



HDE-CTH (10)

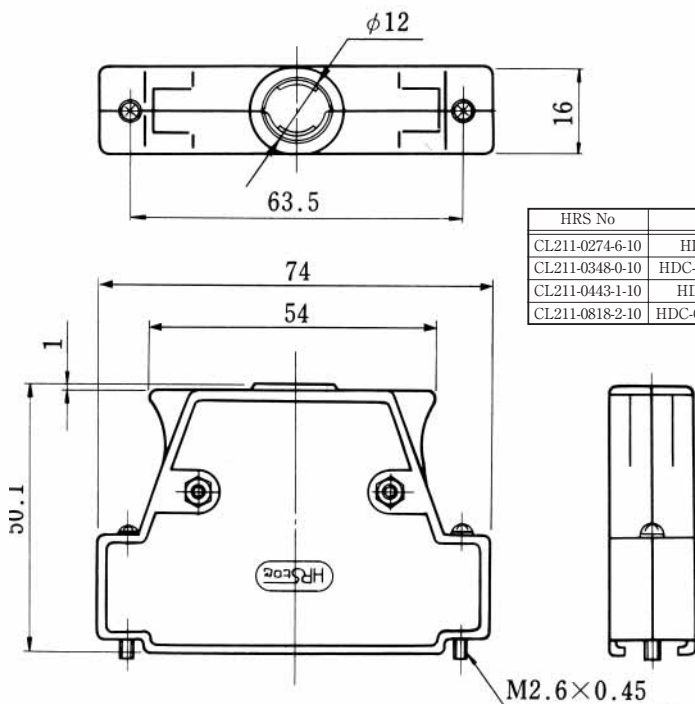

HRS No	Part No.	RoHS
CL211-0274-6-10	HDC-CTH (10)	YES
CL211-0348-0-10	HDC-CTH (4-40) (10)	
CL211-0443-1-10	HDC-CTH1 (10)	
CL211-0818-2-10	HDC-CTH1 (4-40) (10)	

Shielding Characteristics

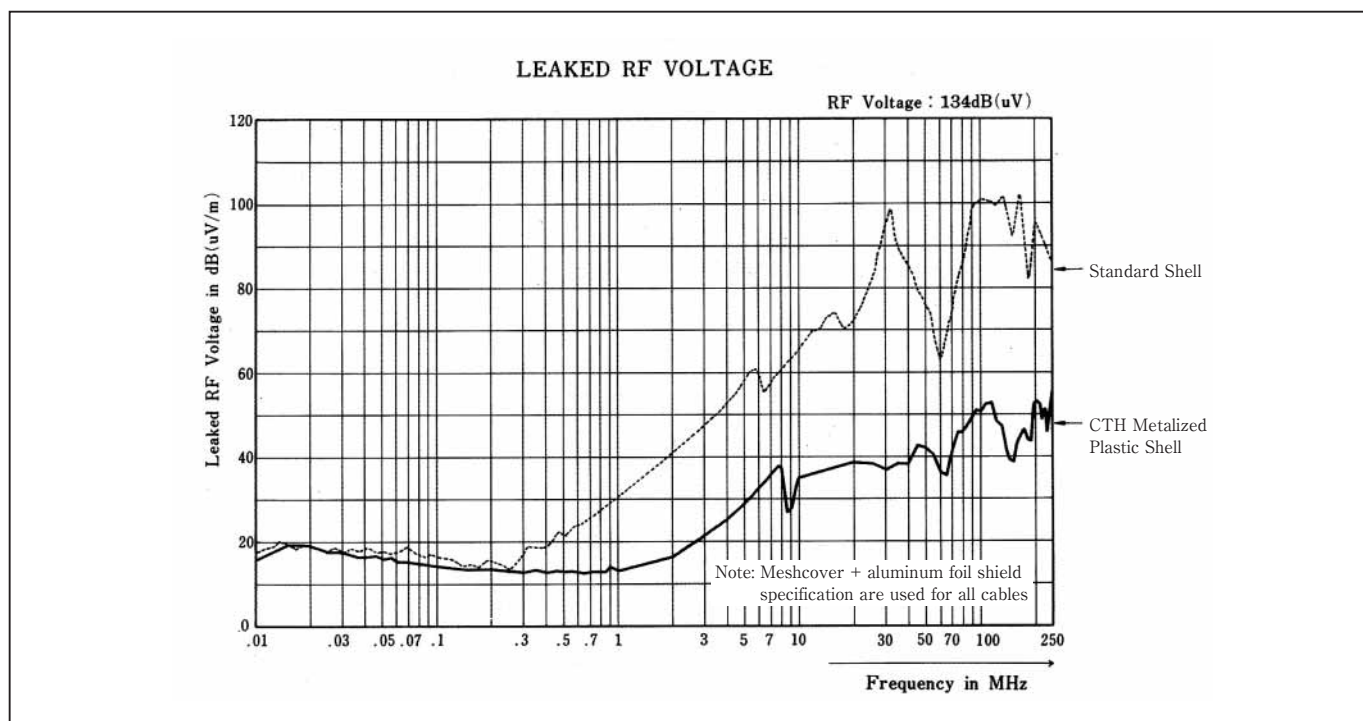

Metalized Plastic Shell Assembling Method

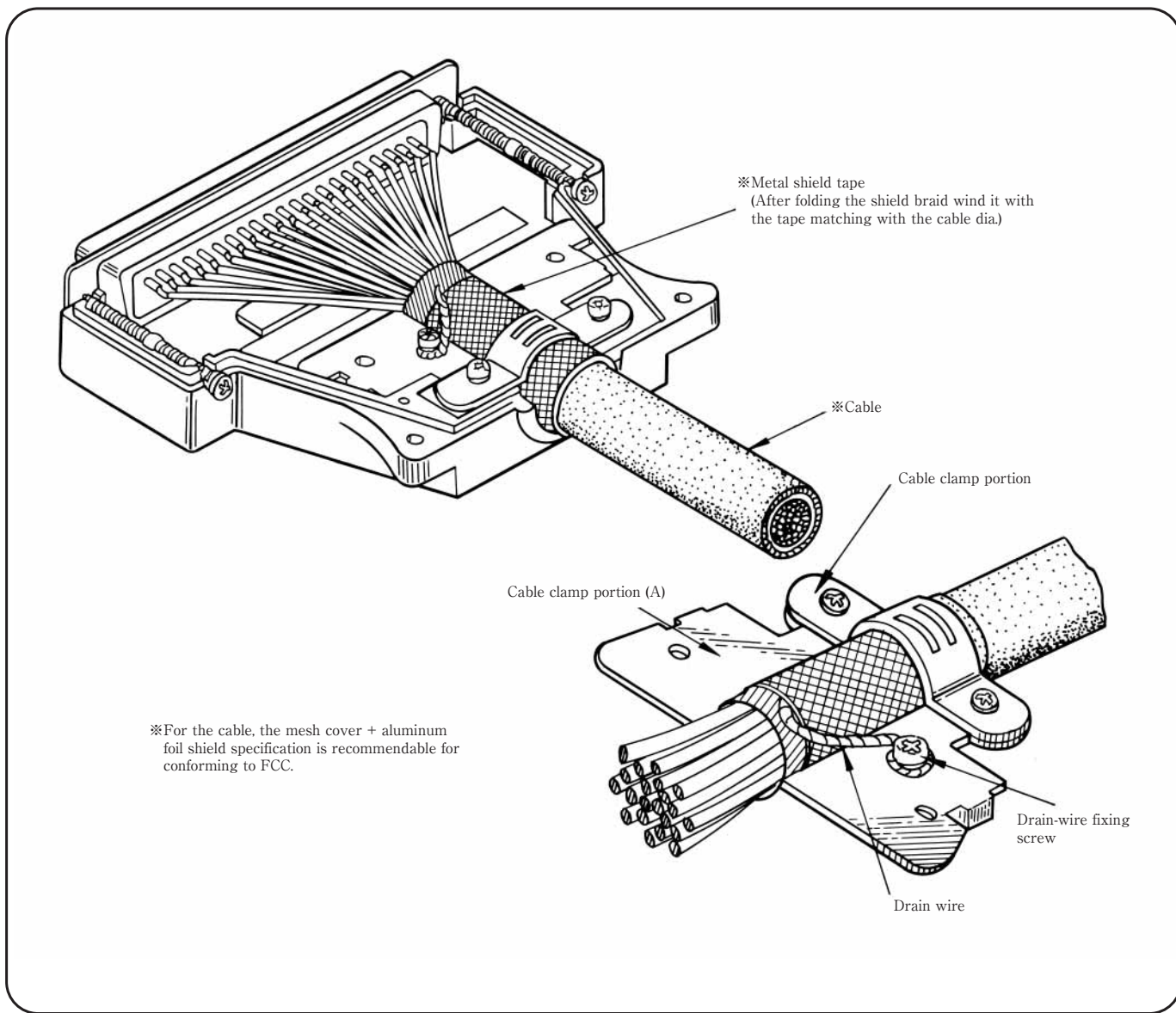

EMI Test Method

