

Small-sized, low profile connector

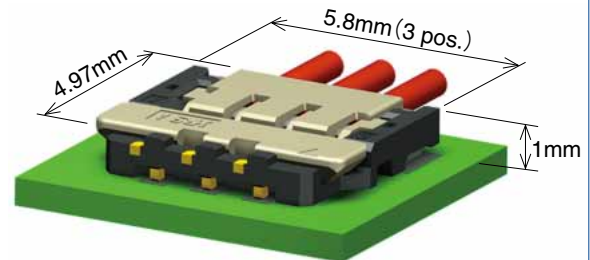

Fig.1

■ Features

1. Small-sized, low profile connector

Low profile design of 1.0mm stacking height, the connector is suitable for small-sized devices.

2. Leveling of the vertical mating cable

Vertical insertion of the connector for mating enhances the assembly operation within device.

3. Proprietary ViSe Lock design

The cable side lock has been strengthened with our proprietary ViSe Lock mechanism*, preventing the cables from being easily disconnected due to tough routing or an excessive load. (*ViSe Lock: Vertical-insertion Swing-extraction)(Fig.2)*Patent pending

4. High current capability up the maximum of 3.0A (2pos. : When 28AWG is used)

By adopting high conductivity material and lowering contact resistance through optimized contact force, high-current capability is achieved in spite of its small size.

5. Highly reliable contact design

Effective mating length of 0.29mm is achieved in spite of low profile 1.0mm stacking height. The 2-point clipping contact stabilizes contact resistance.

6. Halogen-free*

*As defined by IEC 61249-2-21

Br-900ppm max, Cl-900ppm max, Br+Cl-1,500ppm max

Description of the ViSe Lock Design

Insertion operation appears to be vertical mating. However, it is actually inserted at an angle which ensures high retention force in upper direction.

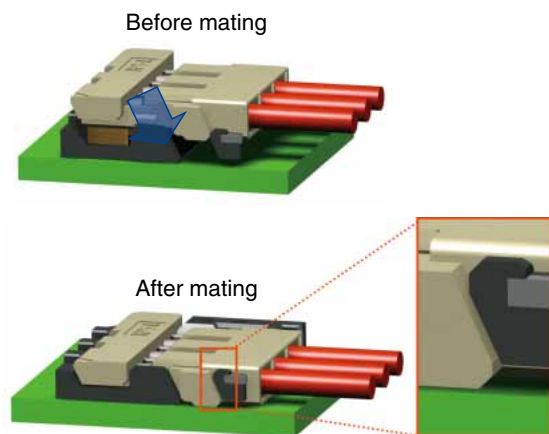

Fig.2

Contact design

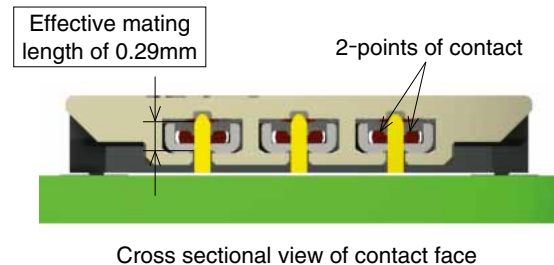

Fig.3

Product Specifications

| | | | | | | | |
|--------|----------------|--------------|-------|-------|-------|--|--|
| Rating | Current rating | | 2pos. | 3pos. | 4pos. | 6pos. | Operating temperature range -55°C to 85°C (Note 1) Operating humidity range 20% to 80% (Note 2) |
| | | 28AWG | 3.0A | 2.5A | 2.0A | | |
| | 30AWG | 2.5A | 2.0A | 1.5A | | | |
| | Voltage rating | 100V AC / DC | | | | Storage temperature range -10°C to 60°C (Note 3) Storage humidity range 40% to 70% (Note 3) | |

| Item | Specification | Conditions |
|---------------------------------|--|--|
| 1. Insulation resistance | 100MΩ min. | 100V DC |
| 2. Withstanding voltage | No flashover or insulation breakdown | 500V AC / 1 minute |
| 3. Contact resistance | 10mΩ max. | 20mV max. at 1mA. |
| 4. Vibration | No electrical discontinuity of 1μs or longer No damage, cracks or parts dislocation. | Frequency : 10 to 55Hz, single amplitude of 0.75mm, 10 cycles, 3 direction |
| 5. Shock | No electrical discontinuity of 1μs or longer No damage, cracks or parts dislocation. | Acceleration of 490m/s ² , 11ms duration, sine half-wave, 3 cycles in each of the 3 axis |
| 6. Humidity | Contact resistance : 20mΩ max., Insulation resistance : 100MΩ min. No damage, cracks or parts dislocation. | 96 hours at 40 ±2°C, and humidity of 90 to 95% |
| 7. Temperature cycle | Contact resistance : 20mΩ max., Insulation resistance : 100MΩ min. No damage, cracks or parts dislocation. | -55°C → 5 to 35°C → 85°C → 5 to 35°C Times : 30 min. → 2 min. to 3 min. → 30 min. → 2 min. to 3 min. 5 cycles |
| 8. Durability | Contact resistance : 20mΩ max., No damage, cracks or parts dislocation. | 10 cycles |
| 9. Resistance to soldering heat | No deformation of components affecting performance | Reflow : See recommended temperature profile (Page 6) Manual soldering : 350°C for 3 seconds |

Note 1 : Includes temperature rise caused by operating current.

Note 2 : Use in environments without condensation.

Note 3 : The term "storage" refers to products stored for a long period prior to soldering or usage.

The operating temperature and humidity range covers the non-conducting condition of installed connectors in storage, shipment or during transportation.

Materials / Finish

| Product | Part | Material | Finish | Remarks |
|----------------|-----------|--------------|------------|---------|
| Header | Insulator | LCP | Black | UL94V-0 |
| | Contacts | Copper Alloy | Tin Plated | — |
| Crimp socket | Insulator | LCP | Natural | UL94V-0 |
| Crimp contacts | Contacts | Copper Alloy | Tin Plated | — |

Product Number Structure

Refer to the chart below when determining the product specifications from the product number.

Please select from the product numbers listed in this catalog when placing orders.

● Header

DF 58 - * P 1.2 V

① ② ③ ④ ⑤ ⑥

| | |
|-----------------------------------|---|
| ① Series name : DF | ⑤ Contact pitch : 1.2mm |
| ② Series No. : 58 | ⑥ Termination section V : Straight SMT |
| ③ Number of contacts : 2, 3, 4, 6 | |
| ④ Connector type P : Header | |

● Crimp socket

DF 58 - * S - 1.2 C

① ② ③ ④ ⑤ ⑥

| | |
|-----------------------------------|---|
| ① Series name : DF | ⑤ Contact pitch : 1.2mm |
| ② Series No. : 58 | ⑥ Termination section C : Crimp socket |
| ③ Number of contacts : 2, 3, 4, 6 | |
| ④ Connector type S : Socket | |

● Crimp contact

DF 58 - 2830 SCF

① ②

| | |
|--|--|
| ① Applicable wire size 2830 : 28 to 30AWG | ② Packaging SCF : Female crimp contact / reel |
|--|--|

Header (SMT)

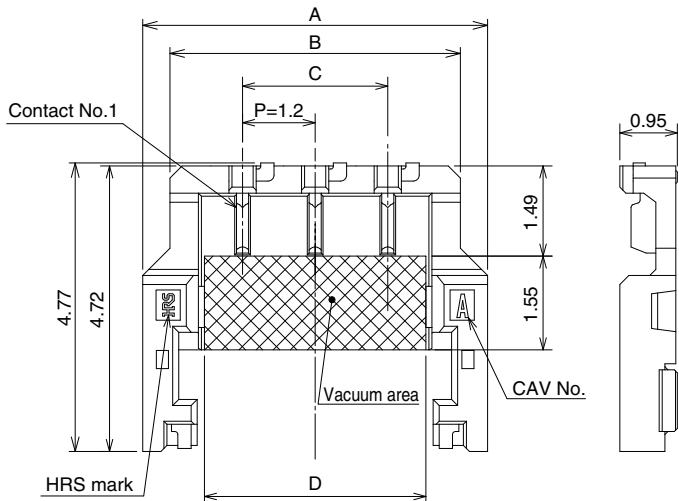

Recommended PCB layout

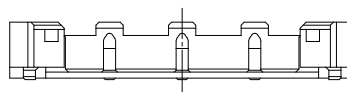
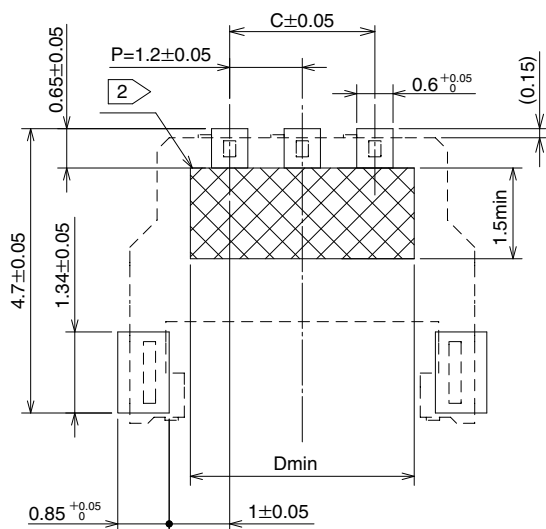

[Specification number]
 (21) : Tin plated, Embossed tape packaging (6,000pcs/reel)

Unit : mm

| Part No. | HRS No. | No. of contacts | A | B | C | D |
|------------------|---------------|-----------------|-----|-----|-----|-----|
| DF58-2P-1.2V(21) | 666-1001-0 21 | 2 | 4.5 | 3.6 | 1.2 | 2.5 |
| DF58-3P-1.2V(21) | 666-1002-0 21 | 3 | 5.7 | 4.8 | 2.4 | 3.7 |
| DF58-4P-1.2V(21) | 666-1003-0 21 | 4 | 6.9 | 6.0 | 3.6 | 4.9 |
| DF58-6P-1.2V(21) | 666-1005-0 21 | 6 | 9.3 | 8.4 | 6.0 | 7.3 |

Note 1 : Embossed tape reel packaging (6,000pcs/reel).

Note 2 : The crossed-hatched area is a no conductive trace area.

Oct.1.2021 Copyright 2021 HIROSE ELECTRIC CO., LTD. All Rights Reserved.

● Packaging Specification

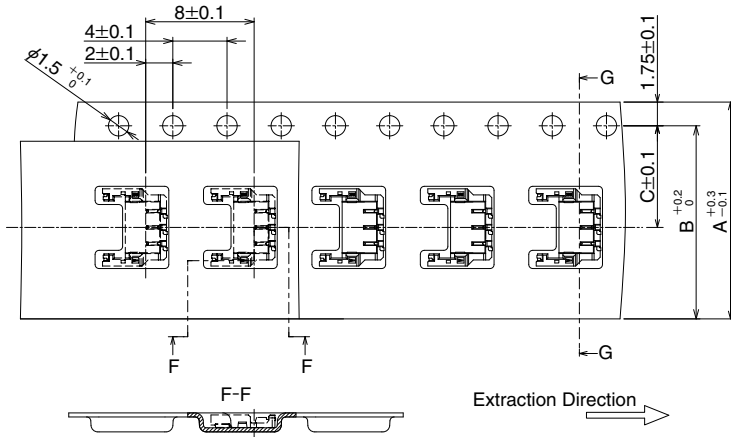

● Reel Shape

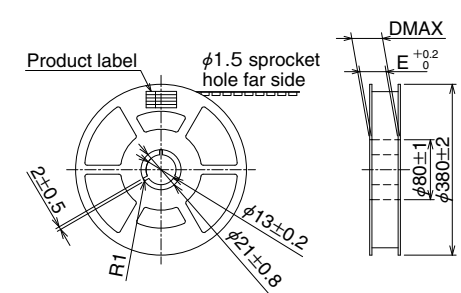

Unit : mm

| Part No. | A | B | C | D | E |
|------------------|----|-------|------|------|------|
| DF58-2P-1.2V(21) | 16 | 14.25 | 7.5 | 22.4 | 16.4 |
| DF58-3P-1.2V(21) | | | | | |
| DF58-4P-1.2V(21) | 24 | 22.25 | 11.5 | 30.4 | 24.4 |
| DF58-6P-1.2V(21) | | | | | |

■ Crimp socket

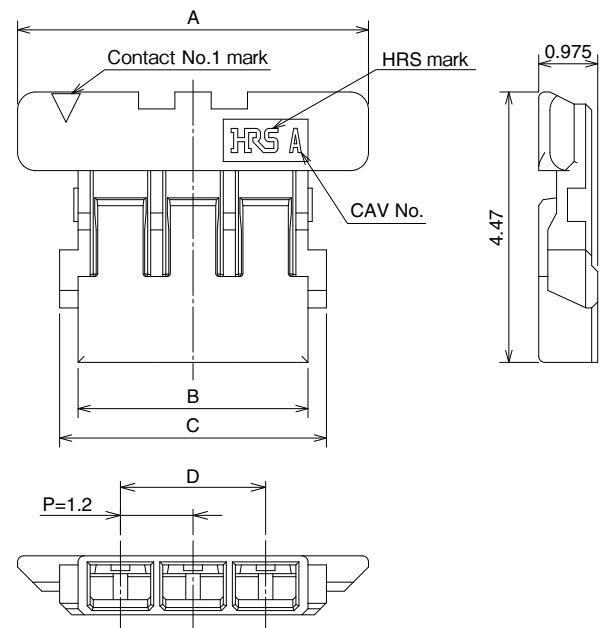

Unit : mm

| Part No. | HRS No. | No. of contacts | A | B | C | D |
|--------------|---------------|-----------------|-----|-----|------|-----|
| DF58-2S-1.2C | 666-1006-0 00 | 2 | 4.6 | 2.6 | 3.21 | 1.2 |
| DF58-3S-1.2C | 666-1007-0 00 | 3 | 5.8 | 3.8 | 4.41 | 2.4 |
| DF58-4S-1.2C | 666-1008-0 00 | 4 | 7.0 | 5.0 | 5.61 | 3.6 |
| DF58-6S-1.2C | 666-1010-0 00 | 6 | 9.4 | 7.4 | 8.01 | 6.0 |

Note 1 : Please order by number of packing (1,000pcs/packing).

■ Crimp contact

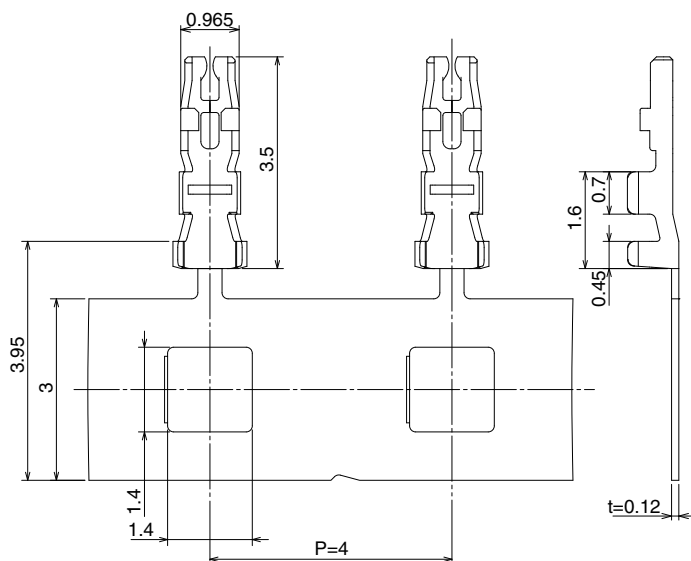

Unit : mm

| Part No. | HRS No. | Packaging | Quantity | Finish |
|--------------|---------------|-----------|----------|------------|
| DF58-2830SCF | 666-1011-0 00 | Reel | 40,000 | Tin plated |

Note : This product is delivered in 40,000 pieces per reels.
Please place orders in multiples of 40,000 pieces.

● Applicable wire (Tin plated annealed copper wire)

Unit : mm

| Wire size (Stranded wire conductor) | Jacket outer diameter | Recommended cable | Strip length |
|--|-----------------------|--------------------|--------------|
| 28AWG (7 / ϕ 0.127mm) | ϕ 0.5 to 0.6mm | UL1571 (Thin wire) | 1.0 to 1.4mm |
| 30AWG (7 / ϕ 0.102mm) | | | |

Note 1 : When using other than the recommended wire, contact your nearest Hirose sales representative.

Note 2 : The strip length is a reference value. Please make adjustments so finished crimps will meet the specified values.
Refer to the crimping quality standards (ATAD-H0848-00) for details.

◆ Tools

Unit : mm

| Type | Part No. | HRS No. | Applicable contact |
|-------------------------|-------------------|-------------------|--------------------|
| Applicator | AP105-DF58-2830S | 901-4649-0 00 | DF58-2830SCF |
| Press | CM-105C | 901-0001-0 00 | |
| Hand crimping tool | HT307/DF58-2830HC | Under development | |
| Contact extraction tool | DF-C-PO(B) | 550-0179-2 00 | |

Note : If any trouble has occurred due to tools other than the designated tool, Hirose bears no responsibility for any trouble.

◆ Operating Precautions

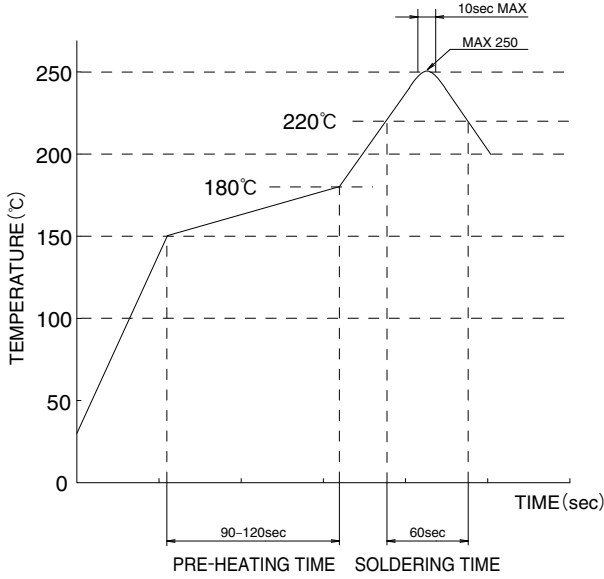
| | |
|--|--|
| <p>1. Recommended Temperature Profile (Lead-free soldering possible)</p> |  <p>[Applicable Conditions]</p> <ol style="list-style-type: none"> 1. Peak Temperature : MAX 250°C 2. Heated Area : 220°C or above, within 60 sec. 3. Pre-heating Area : 150-180°C, 90-120 sec. 4. Number of Operation : Twice or less <p>* The contact lead area was measured.</p> <p>The conditions may change depending on the types and manufacturers of cream solder, PCB size, and conditions of other materials used for soldering. Please fully check the soldering condition before use.</p> <p>[Remarks 1] This temperature profile is our recommended value.</p> |
| <p>2. Recommended Hand Solder Conditions</p> | <p>Soldering iron temperature : 350 ± 10°C, soldering time : within 3 seconds</p> |
| <p>3. Recommended Screen Thickness, Aperture Opening Rate (Pattern Area Ratio)</p> | <p>Thickness 0.1mm, aperture opening rate : 100%</p> |
| <p>4. PCB Warpage</p> | <p>Max 0.02mm at the center of connector with the both edges of the connector as the baseline.</p> |
| <p>5. Cleaning Condition</p> | <p>Cleaning with IPA is possible. (Cleaning is not recommended as it may change the feel of insertion/extraction, etc. Please consult with us when using other types of cleaning agents.)</p> |
| <p>6. Precautions</p> | <ul style="list-style-type: none"> ■ Insertion/extraction of the connector while not mounted to the PCB may cause breakage or deformation to the contact. ■ Do not apply flux at the time of hand soldering, as it may result in flux rise. ■ This product may have slightly different hue on molded items, however, they do not affect the product performance. ■ See the separate “DF58 Insertion/Extraction Procedure Manual” for handling precautions at the time of insertion and extraction. |

Oct.1.2021 Copyright 2021 HIROSE ELECTRIC CO., LTD. All Rights Reserved.

◆ Usage Recommendation

7. Insertion and removal operation method

Mating

(1) Placing the crimp socket

Insert the crimp socket by aligning to the housing outline.

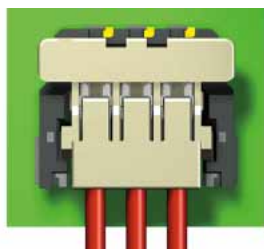

If crimp socket is correctly aligned, the top face of the crimp socket becomes parallel to the PCB.

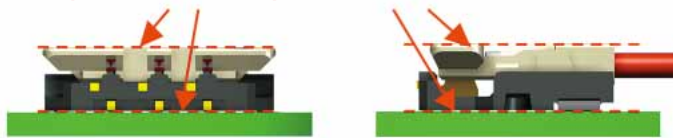

(2) Insertion

Press down in the center of the crimp socket, and mating is complete.

Press down in the center.

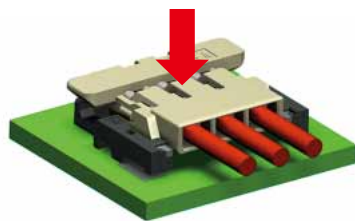

Mating is finished.

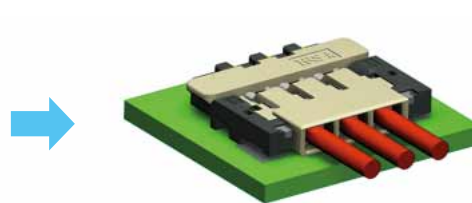

(3) Checking the mated state

Check if the crimp socket is securely mated.

If one end floats or is mated at an angle, unmate, and mate it again.



If the connector is inserted when the crimp socket isn't placed correctly, only the friction lock on the non-cable side may be inserted as shown in the Figure below. In this case, unmate, and mate it again. Forced mating will lower the retention force.

Insert it over again.

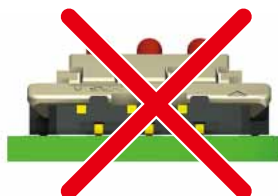
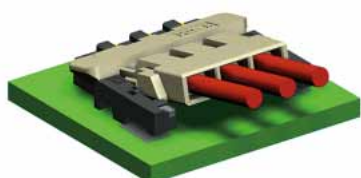

◆ Recommended Usage

7. Insertion and removal operation method

Pull-out operation

Pull-out operation starts by hooking on either side of the protrusion to release the crimp socket and pull up to release the friction lock. Raise the entire crimp socket and complete the operation.

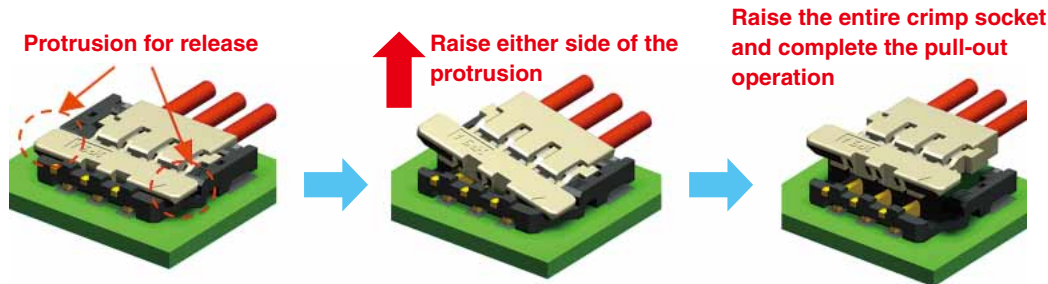

Use the protrusion for release at the time of pull-out operation. If you forcibly remove it by pulling the cable, cable disconnection and connector breakage will occur.

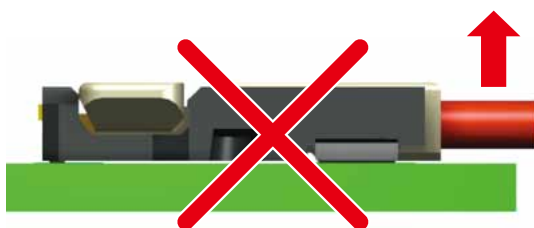

HIROSE ELECTRIC CO.,LTD.

2-6-3,Nakagawa Chuoh,Tsuzuki-Ku,Yokohama-Shi 224-8540,JAPAN

TEL: +81-45-620-3526 Fax: +81-45-591-3726

<http://www.hirose.com>

<http://www.hirose-connectors.com>