

# FX30B Series

## 13 to 25A Compatible, Position Misalignment Absorption Type Power Supply Connector for PCB Connections

**FunctionMAX™**



Power Supply



Floating



Wide Variation



Mar. 1. 2025 Copyright 2025 HIROSE ELECTRIC CO., LTD. All Rights Reserved.



## Features

1. Contact Pitch :  
3.81mm , 7.62mm

2. Current Capacity :  
13 to 25A/pin

\*For details, see the derating curve.

3. Connection Type: Coplanar /  
Vertical / Parallel

4. Number of Pos. : 2 / 3 / 4 /  
5 Pos.

5. Position Misalignment  
Absorption Movable Amount:  
 $\pm 0.3\text{mm}$

- (1) Prevents to mounting misalignment when using multiple connectors.
- (2) Other products without position misalignment absorption can be used together.

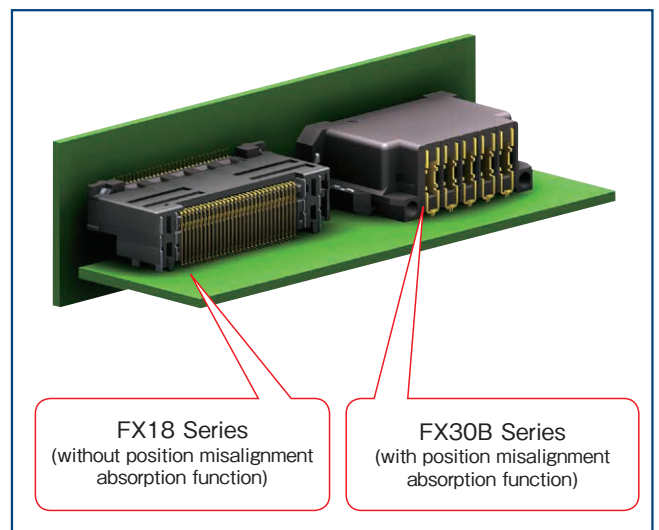

Example of Connector Mounted Next to Another Connector

6. Effective Mating Length :  
2mm

The effective mating length is 2mm long, so it has an enough margin for the mating stroke. (3.0mm for longer contacts)

7. Multi-Point Contact Design

It has superior contact reliability by employing an independent four-point contact spring structure.

## 8. Low Insertion / Extraction Force

It offers low insertion/extraction force by employing a two-step contact timing sequence.

## 9. Robustness

Retention tabs that securely fix the connector to the PCB are added on both sides of the connector, providing excellent deformation resistance for up, down, left and right directions.

## 10. Large Guide Form Leads Superior Mating Ability

A large induction form has been provided, allowing easy mating operations.  
Induction amount :  $\pm 1.3\text{mm}$   
with position misalignment absorption amount :  $\pm 1.6\text{mm}$

## 11. Protected Design

Our proprietary protective wall prevents foreign materials from contacting the sensitive areas.  
(Compatible to JIS C 0922 Probes for verification B)

## 12. UL, C-UL and TÜV certifications have been achieved.

## Product Specifications

Rated Current (Note 1) Ambient Temp 25°C	No of Pos.	Rated Current	Operating Temperature Range (Note 2)	-55 to +105°C
	2	23A	Storage Temperature Range (Note 3)	-10 to +60°C
	3	22A		
	4	20A		
	5	20A		
	2 (7.62mm Pitch)	25A		
	3 (7.62mm Pitch)	24A		

Operating Humidity Range	Relative Humidity 85% Max. (Not dewed)	Storage Humidity Range (Note 3)	40% to 70%
--------------------------	--	---------------------------------	------------

UL	Rated Current (Note 1)	No of Pos.	Rated Current
		2	16A
		3	15A
		4	13A
		5	13A
		2 (7.62mm Pitch)	18A
		3 (7.62mm Pitch)	16A
	Rated Voltage	3.81mm pitch	7.62mm pitch
		250V AC/DC	600V AC/DC

C-UL	Rated Current (Note 1)	No of Pos.	Rated Current
		2	16A
		3	15A
		4	13A
		5	13A
		2 (7.62mm Pitch)	18A
		3 (7.62mm Pitch)	16A
	Rated Voltage	3.81mm pitch	7.62mm pitch
		250V AC/DC	600V AC/DC

TÜV	Rated Current (Note 1)	No of Pos.	Rated Current
		2	17A
		3	16A
		4	15A
		5	15A
		2 (7.62mm Pitch)	19A
	3 (7.62mm Pitch)	18A	
	Rated Voltage	3.81mm pitch	7.62mm pitch
150V AC/DC		600V AC/DC	

UL/C-UL/TÜV File No. and Confirmation No.  
 UL/C-UL E52653 (Acc. to UL1977 / CSA C22.2 No.182.3-M1987)  
 TÜV R50275872 (Acc. to EN61984 : 2009)

Item	Specification	Conditions
Contact Resistance	2m $\Omega$ Max.	Measured at 10mA
Insulation Resistance	1000M $\Omega$ Min.	Measured at 250V DC
Withstanding Voltage	No flashover or breakdown	Conduct electricity by applying a voltage of 750V AC for 1 min.
Mating Durability	Contact resistance : 5 m $\Omega$ Max.	100 times
Vibration Resistance	No electrical discontinuity of 1 $\mu$ s or more	Frequency : 10 to 55Hz, half amplitude : 0.75mm, 10 cycles in each of 3 axis directions for 5 minutes/cycle
Shock Resistance	No electrical discontinuity of 1 $\mu$ s or more	Acceleration of 490m/s <sup>2</sup> , duration 11ms, sine half-wave, 3 cycles in each of the 3 axes each in both directions
Humidity Resistance	Contact Resistance : 5m $\Omega$ Max. Insulation Resistance : 1000M $\Omega$ Min.	Temperature : +40°C , humidity : 90 to 95%, left for 96 hours
Temperature Cycle	Contact Resistance : 5m $\Omega$ Max. Insulation Resistance : 1000M $\Omega$ Min.	Temperature : -55 $\rightarrow$ +105°C Time : 30 $\rightarrow$ 30 min., 5 cycles
Solder Heat Resistance	No melting of resin part, which affects the product performance	Solder tank : solder tank temperature : +260°C , 10 seconds Manual soldering : soldering iron temperature : +380°C , 10 seconds

Note 1 : Current rating per 1 contact is used.

Note 2 : Includes temperature rise caused by current flow.

Note 3 : The term "storage" refers to the long-term storage condition of unused products before PCB mounting.

## Derating Curve

### ● Normal Type

The derating curve is created by multiplying a derating factor of 0.8 to the current value of the base curve.

(Electricity conducted through the 5 pins of 5-pin coplanar connection type connector)

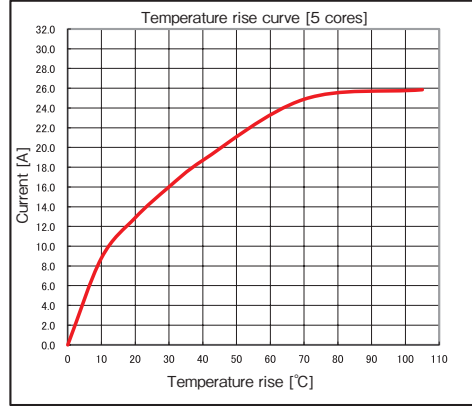
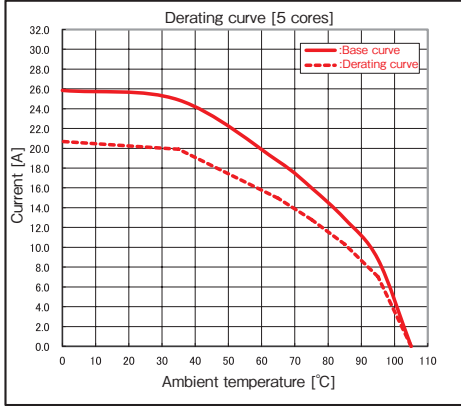

(Electricity conducted through the 4 pins of 4-pin coplanar connection type connector)

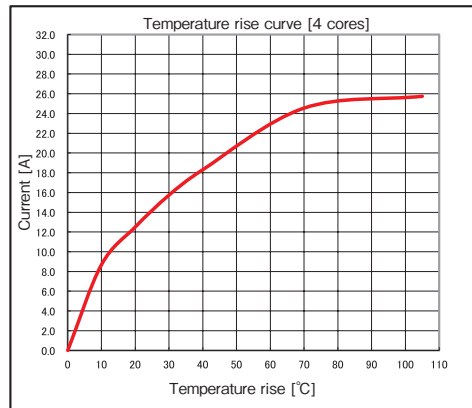
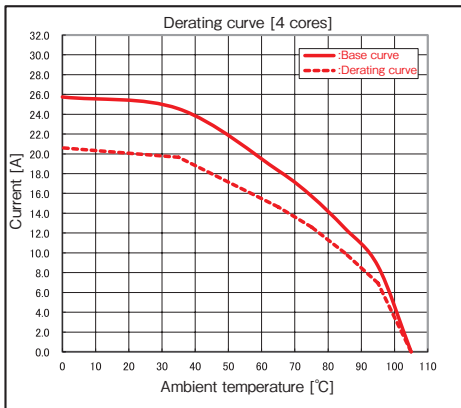

(Electricity conducted through the 3 pins of 3-pin coplanar connection type connector)

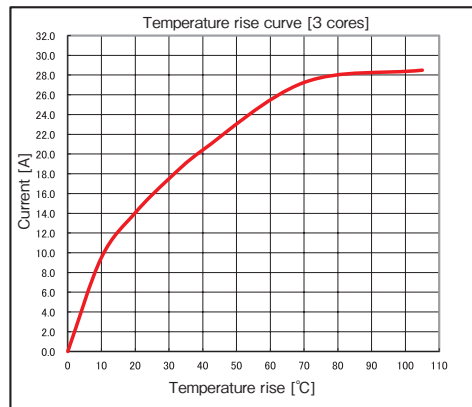
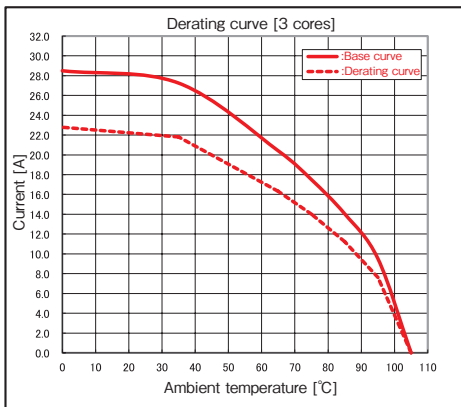

(Electricity conducted through the 2 pins of 2-pin coplanar connection type connector)

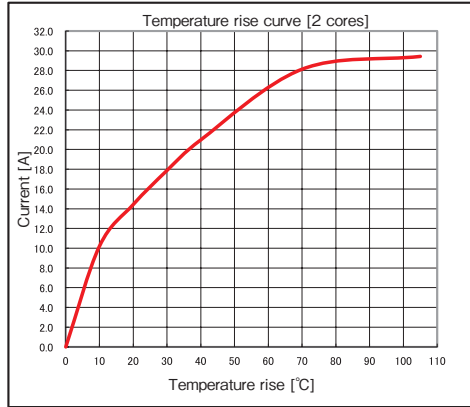
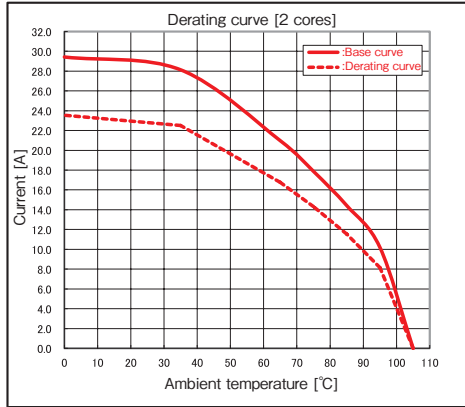

● One Pin Skipped Type

The derating curve is created by multiplying a derating factor of 0.8 to the current value of the base curve.

(Electricity conducted through the 3 pins of 3-pin coplanar connection type connector)

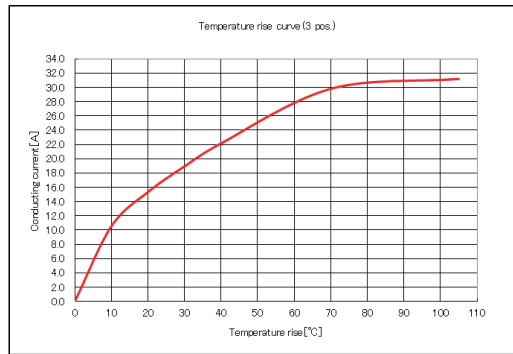
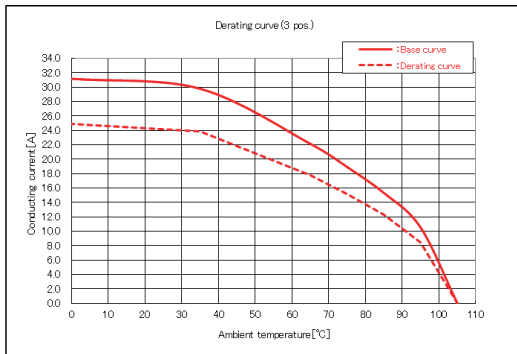

(Electricity conducted through the 2 pins of 2-pin coplanar connection type connector)

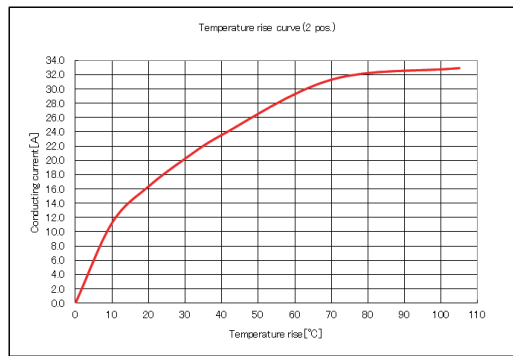
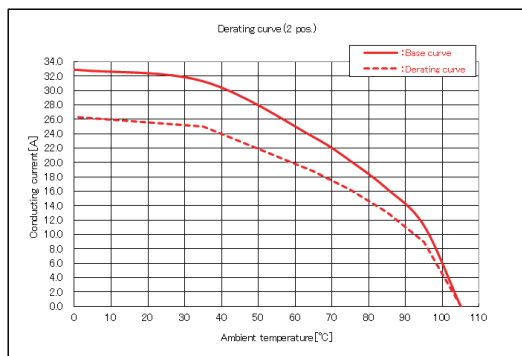

Materials / Finish

● Receptacle/Header

Part	Material	Color/Finish	Specification
Insulator	PA	Black	UL94V-0
Power Supply Contact	Copper alloy	Contact Area : Gold Plating Mounting Area : Pure Tin Plating	-
Retention Tab	Phosphorous bronze	Whole Body : Pure Tin Plating	-

## Product Number Structure

Refer to the chart below when determining the product specifications from the product number.  
Please select from the product numbers listed in this catalog when placing orders.

### ■ Receptacle

**FX30B - 5 S - 3.81 DS**

①            ② ③            ④            ⑤

### ■ Header

**FX30B - 5 P - 3.81 DSA 20**

①            ② ③            ④            ⑤            ⑥

① Series Name	FX30B	④ Contact Pitch	3.81mm
② No. of Pos.	2 to 5	⑤ Product Type	DS : Right Angle Type DSA : Straight Type
③ Connector Type	S : Receptacle Type P : Header Type	⑥ Stacking Height Type	

### ■ Receptacle (One pin skipped type)

**FX30B - 3 S - 7.62 DS**

①            ② ③            ④            ⑤

### ■ Header (One pin skipped type)

**FX30B - 3 P - 7.62 DSA 20**

①            ② ③            ④            ⑤            ⑥

① Series Name	FX30B	④ Contact Pitch	7.62mm
② Number of Contacts	2, 3	⑤ Product Type	DS : Right angle type DSA : Straight type
③ Connector Type	S : Receptacle type P : Header type	⑥ Stacking Height Type	



## Mating Variations

### Coplanar Connection Type

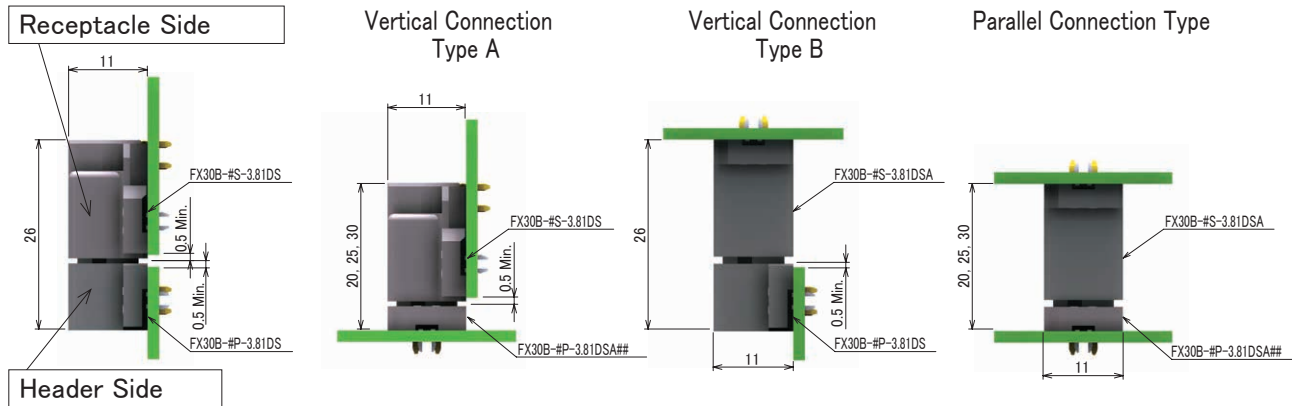

## Functional Diagram

### ● Right Angle Receptacle



### ● Right Angle Header



### ● Straight Receptacle



### ● Straight Header

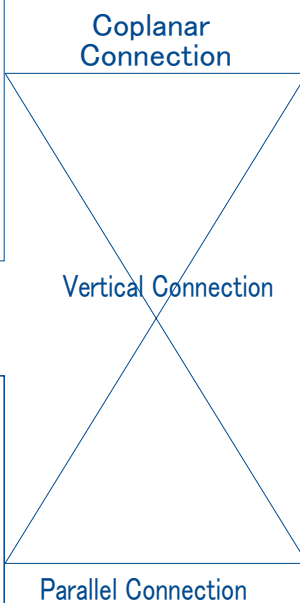

## Stacking Height Dimensions for Parallel Connection Type

### Stacking Height Combinations Table

	FX30B-#P-3.81DSA20 FX30B-#P-7.62DSA20	FX30B-#P-3.81DSA25 FX30B-#P-7.62DSA25	FX30B-#P-3.81DSA30 FX30B-#P-7.62DSA30
FX30B-#S-3.81DSA FX30B-#S-7.62DSA	20mm	25mm	30mm

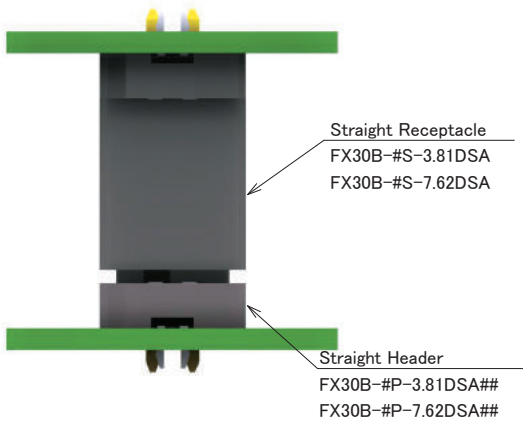

## Right Angle Receptacle (S-DS type)

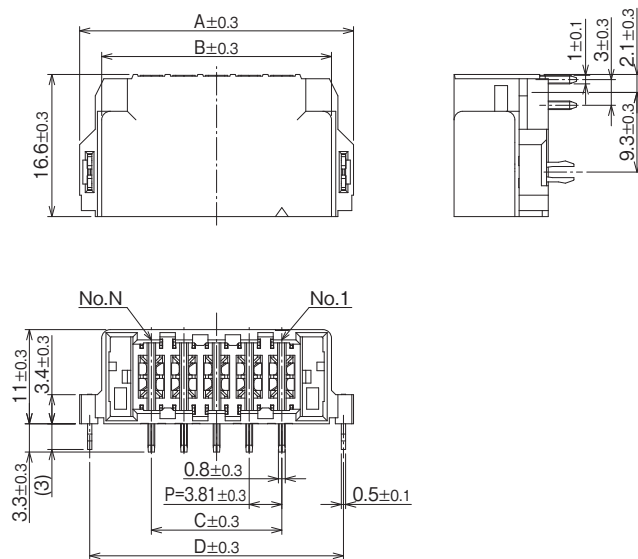

Unit : mm

Part No.	HRS No.	N (No. of Pos.)	A	B	C	D	Purchase Unit
FX30B-2S-3.81DS	CL0570-3600-6-00	2	20.56	15.41	3.81	18.21	35pcs per tray
FX30B-3S-3.81DS	CL0570-3601-9-00	3	24.37	19.22	7.62	22.02	30pcs per tray
FX30B-4S-3.81DS	CL0570-3602-1-00	4	28.18	23.03	11.43	25.83	
FX30B-5S-3.81DS	CL0570-3603-4-00	5	31.99	26.84	15.24	29.64	25pcs per tray

### Recommended PCB Layout Dimensions

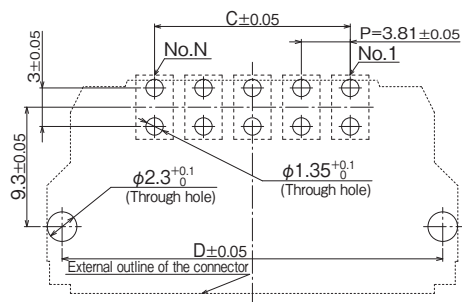

(Note) PCB thickness : t = 1.6mm

## Straight Receptacle (S-DSA type)

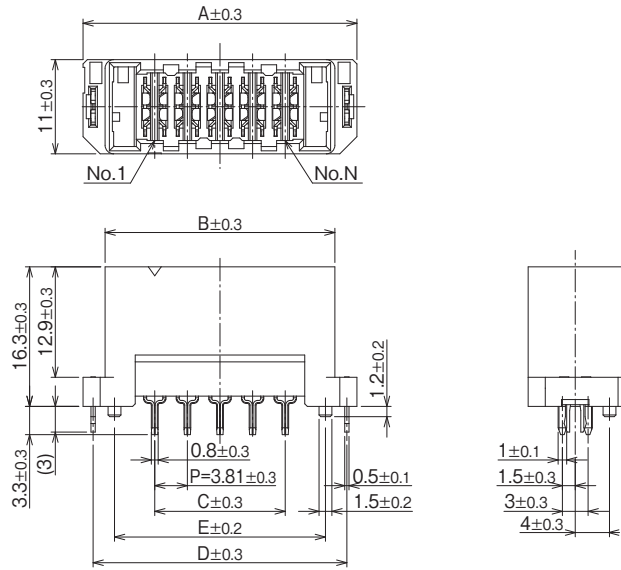

Unit : mm

Part No.	HRS No.	N (No. of Pos.)	A	B	C	D	E	Purchase Unit
FX30B-2S-3.81DSA	CL0570-3500-1-00	2	20.56	15.41	3.81	18.21	13.21	49pcs per tray
FX30B-3S-3.81DSA	CL0570-3501-4-00	3	24.37	19.22	7.62	22.02	17.02	42pcs per tray
FX30B-4S-3.81DSA	CL0570-3502-7-00	4	28.18	23.03	11.43	25.83	20.83	35pcs per tray
FX30B-5S-3.81DSA	CL0570-3503-0-00	5	31.99	26.84	15.24	29.64	24.64	

### Recommended PCB Layout Dimensions

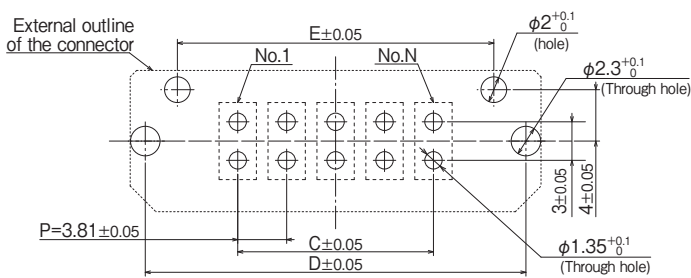

(Note) PCB thickness : t= 1.6mm

## Right Angle Header (P-DS type)

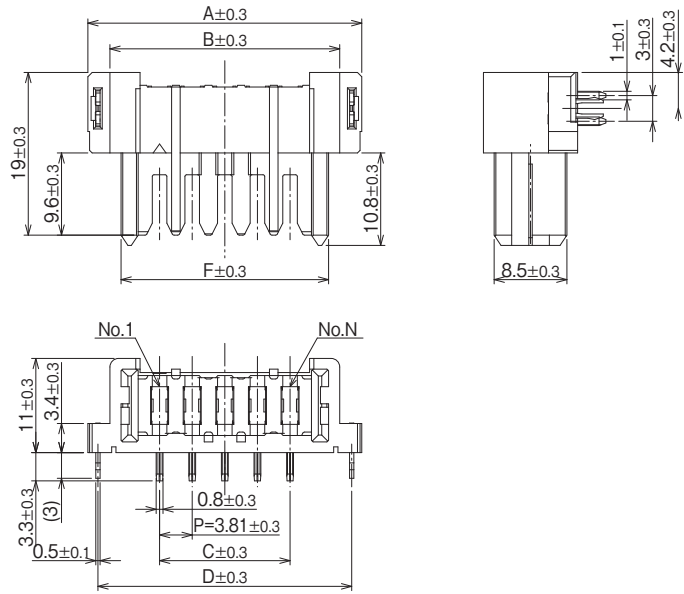

Unit : mm

Part No.	HRS No.	N (No. of Pos.)	A	B	C	D	F	Purchase Unit
FX30B-2P-3.81DS	CL0570-3400-7-00	2	20.56	15.41	3.81	18.21	12.81	28pcs per tray
FX30B-3P-3.81DS	CL0570-3401-0-00	3	24.37	19.22	7.62	22.02	16.62	24pcs per tray
FX30B-4P-3.81DS	CL0570-3402-2-00	4	28.18	23.03	11.43	25.83	20.43	
FX30B-5P-3.81DS	CL0570-3403-5-00	5	31.99	26.84	15.24	29.64	24.24	20pcs per tray

### Recommended PCB Layout Dimensions

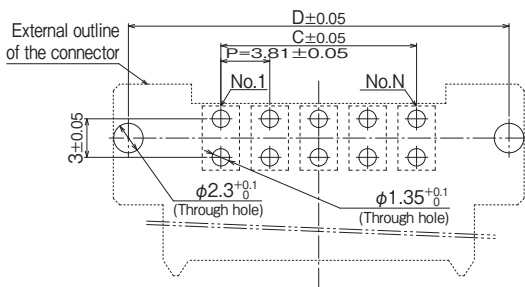

(Note) PCB thickness : t= 1.6mm

## Straight Header - 20 (P-DSA20 type)

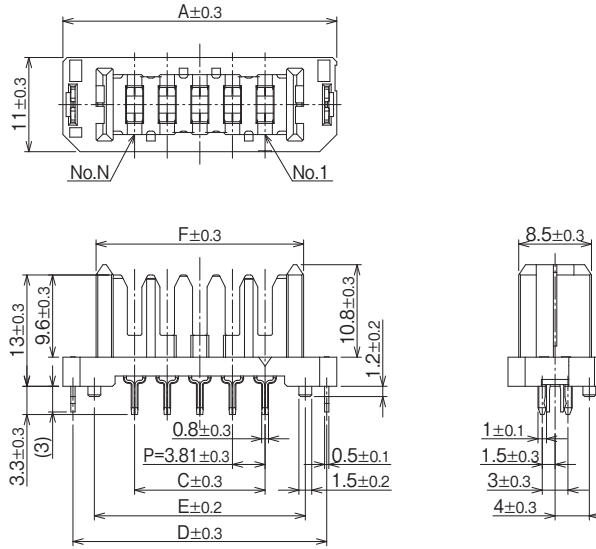
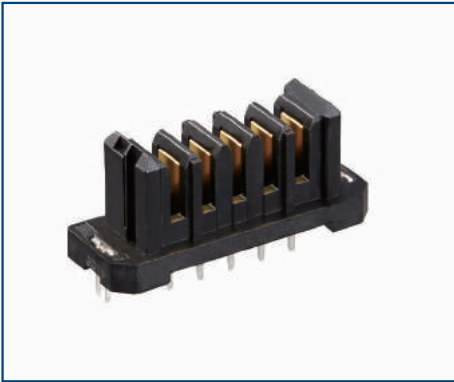

Unit : mm

Part No.	HRS No.	N (No. of Pos.)	A	C	D	E	F	Purchase Unit
FX30B-2P-3.81DSA20	CL0570-3100-3-00	2	20.56	3.81	18.21	13.21	12.81	49pcs per tray
FX30B-3P-3.81DSA20	CL0570-3101-6-00	3	24.37	7.62	22.02	17.02	16.62	42pcs per tray
FX30B-4P-3.81DSA20	CL0570-3102-9-00	4	28.18	11.43	25.83	20.83	20.43	35pcs per tray
FX30B-5P-3.81DSA20	CL0570-3103-1-00	5	31.99	15.24	29.64	24.64	24.24	

### Recommended PCB Layout Dimensions

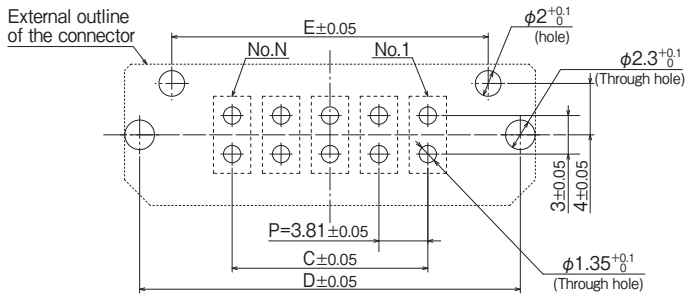

(Note) PCB thickness : t= 1.6mm

## Straight Header - 25 (P-DSA25 type)

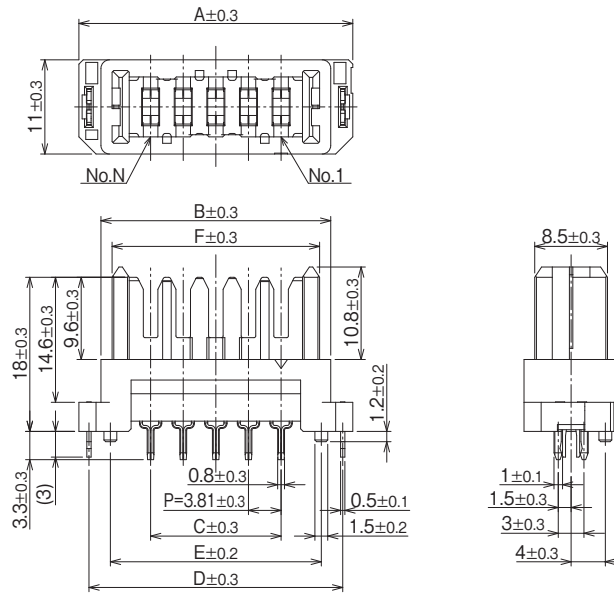
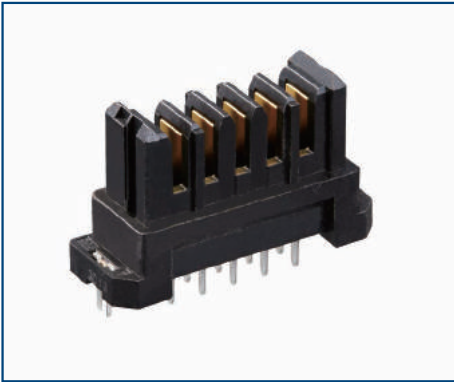

Unit : mm

Part No.	HRS No.	N (No. of Pos.)	A	B	C	D	E	F	Purchase Unit
FX30B-2P-3.81DSA25	CL0570-3200-8-00	2	20.56	15.41	3.81	18.21	13.21	12.81	49pcs per tray
FX30B-3P-3.81DSA25	CL0570-3201-0-00	3	24.37	19.22	7.62	22.02	17.02	16.62	42pcs per tray
FX30B-4P-3.81DSA25	CL0570-3202-3-00	4	28.18	23.03	11.43	25.83	20.83	20.43	35pcs per tray
FX30B-5P-3.81DSA25	CL0570-3203-6-00	5	31.99	26.84	15.24	29.64	24.64	24.24	

### Recommended PCB Layout Dimensions

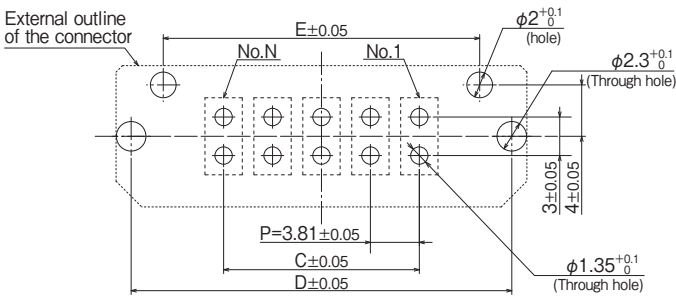

(Note) PCB thickness : t = 1.6mm

## Straight Header - 30 (P-DSA30 type)

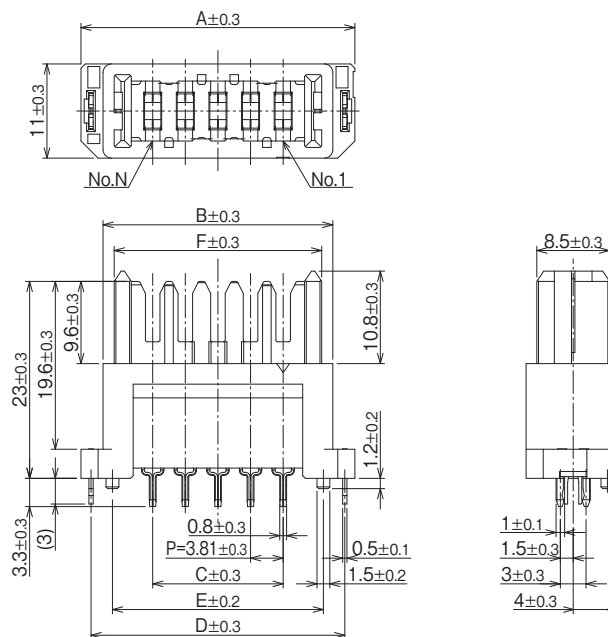

Unit : mm

Part No.	HRS No.	N (No. of Pos.)	A	B	C	D	E	F	Purchase Unit
FX30B-2P-3.81DSA30	CL0570-3300-2-00	2	20.56	15.41	3.81	18.21	13.21	12.81	49pcs per tray
FX30B-3P-3.81DSA30	CL0570-3301-5-00	3	24.37	19.22	7.62	22.02	17.02	16.62	42pcs per tray
FX30B-4P-3.81DSA30	CL0570-3302-8-00	4	28.18	23.03	11.43	25.83	20.83	20.43	35pcs per tray
FX30B-5P-3.81DSA30	CL0570-3303-0-00	5	31.99	26.84	15.24	29.64	24.64	24.24	

### Recommended PCB Layout Dimensions

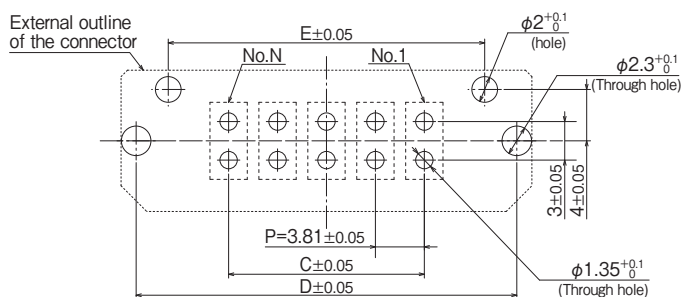

(Note) PCB thickness : t= 1.6mm



## Right Angle Receptacle (S-DS type) One pin skipped type

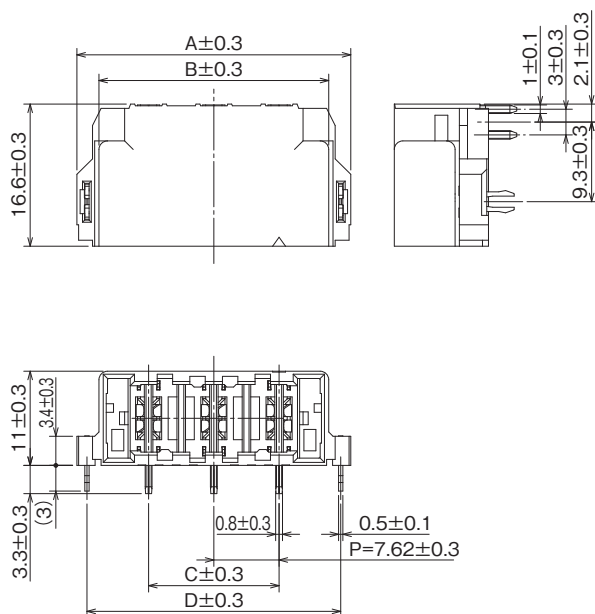

Unit : mm

Part No.	HRS No.	N (No. of Pos.)	A	B	C	D	Purchase Unit
FX30B-2S-7.62DS	CL0570-3604-7-00	2	24.37	19.22	7.62	22.02	30pcs per tray
FX30B-3S-7.62DS	CL0570-3605-0-00	3	31.99	26.84	15.24	29.64	25pcs per tray

### Recommended PCB Layout Dimensions

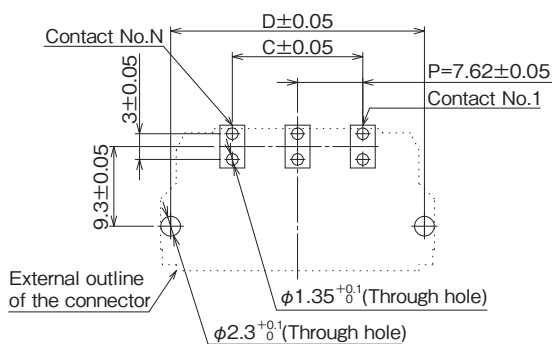

(Note) PCB thickness :  $t = 1.6\text{mm}$

## Straight Receptacle (S-DSA type) One pin skipped type

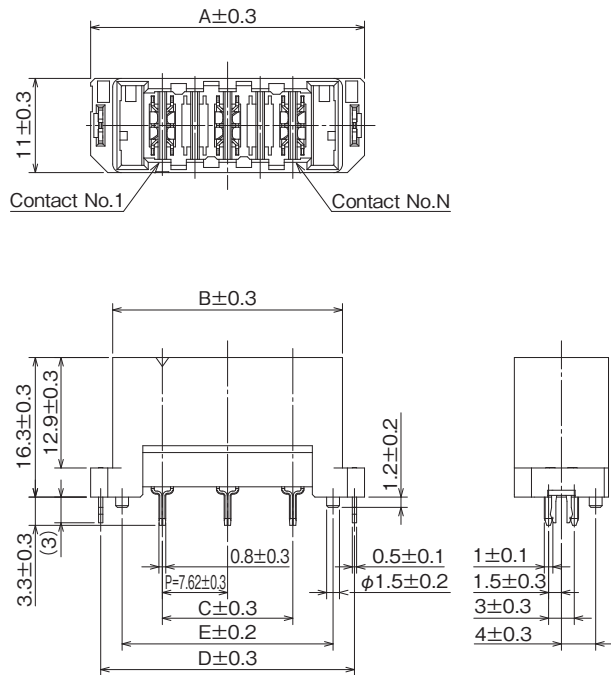

Unit : mm

Part No.	HRS No.	N (No. of Pos.)	A	B	C	D	E	Purchase Unit
FX30B-2S-7.62DSA	CL0570-3504-2-00	2	24.37	19.22	7.62	22.02	17.02	42pcs per tray
FX30B-3S-7.62DSA	CL0570-3505-5-00	3	31.99	26.84	15.24	29.64	24.64	35pcs per tray

### Recommended PCB Layout Dimensions

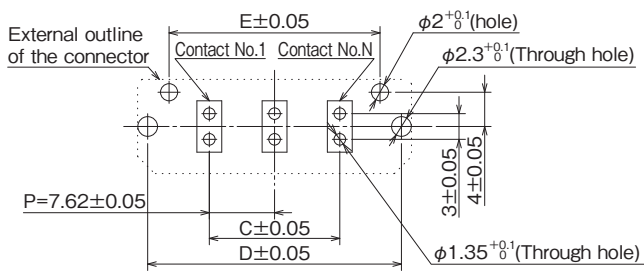
 (Note) PCB thickness :  $t = 1.6\text{mm}$

## Right Angle Header (P-DS type) One pin skipped type

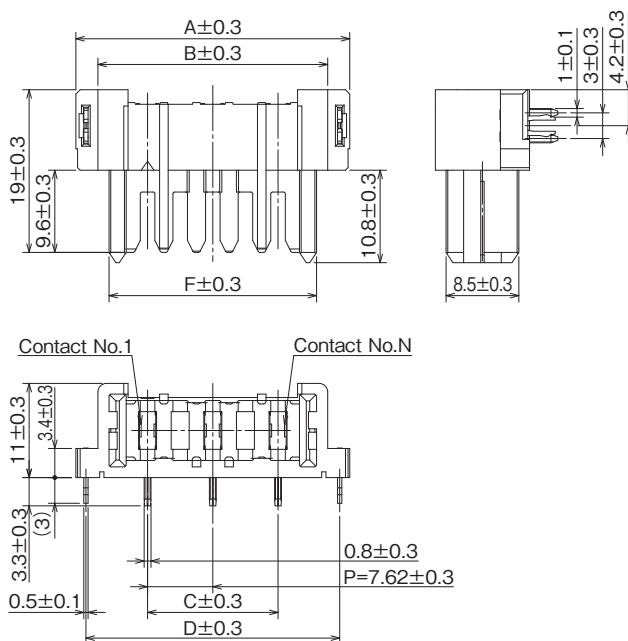

Unit : mm

Part No.	HRS No.	N (No. of Pos.)	A	B	C	D	F	Purchase Unit
FX30B-2P-7.62DS	CL0570-3404-8-00	2	24.37	19.22	7.62	22.02	16.62	24pcs per tray
FX30B-3P-7.62DS	CL0570-3405-0-00	3	31.99	26.84	15.24	29.64	24.24	20pcs per tray

### Recommended PCB Layout Dimensions

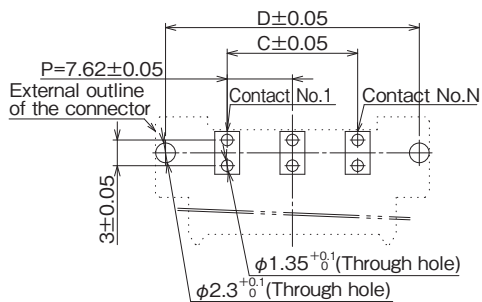

(Note) PCB thickness :  $t = 1.6\text{mm}$

## Straight Header - 20 (P-DSA20 type) One pin skipped type

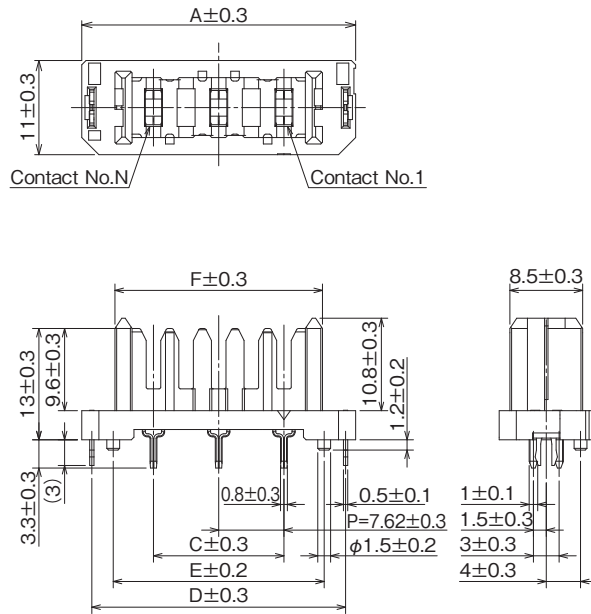

Unit : mm

Part No.	HRS No.	N (No. of Pos.)	A	C	D	E	F	Purchase Unit
FX30B-2P-7.62DSA20	CL0570-3104-4-00	2	24.37	7.62	22.02	17.02	16.62	42pcs per tray
FX30B-3P-7.62DSA20	CL0570-3105-7-00	3	31.99	15.24	29.64	24.64	24.24	35pcs per tray

### Recommended PCB Layout Dimensions

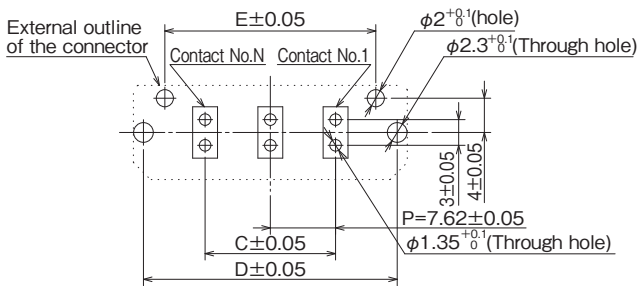

(Note) PCB thickness : t = 1.6mm

## Straight Header - 25 (P-DSA25 type) One pin skipped type

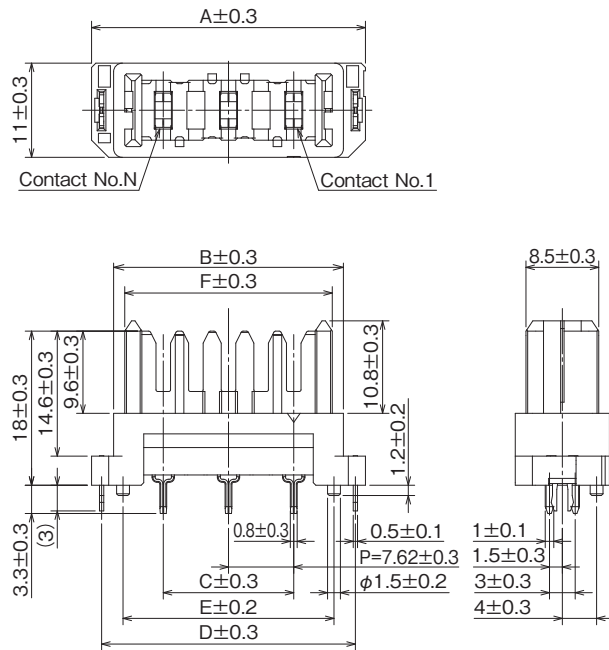

Unit : mm

Part No.	HRS No.	N (No. of Pos.)	A	B	C	D	E	F	Purchase Unit
FX30B-2P-7.62DSA25	CL0570-3205-1-00	2	24.37	19.22	7.62	22.02	17.02	16.62	42pcs per tray
FX30B-3P-7.62DSA25	CL0570-3206-4-00	3	31.99	26.84	15.24	29.64	24.64	24.24	35pcs per tray

### Recommended PCB Layout Dimensions

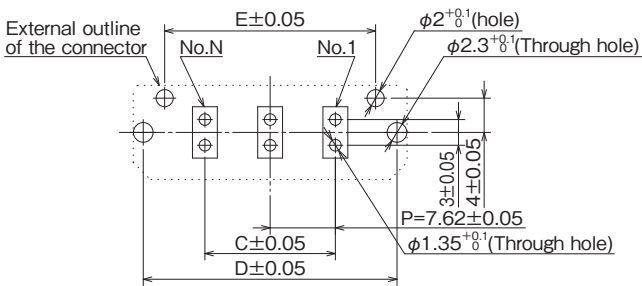

(Note) PCB thickness : t = 1.6mm

## Straight Header - 30 (P-DSA30 type) One pin skipped type

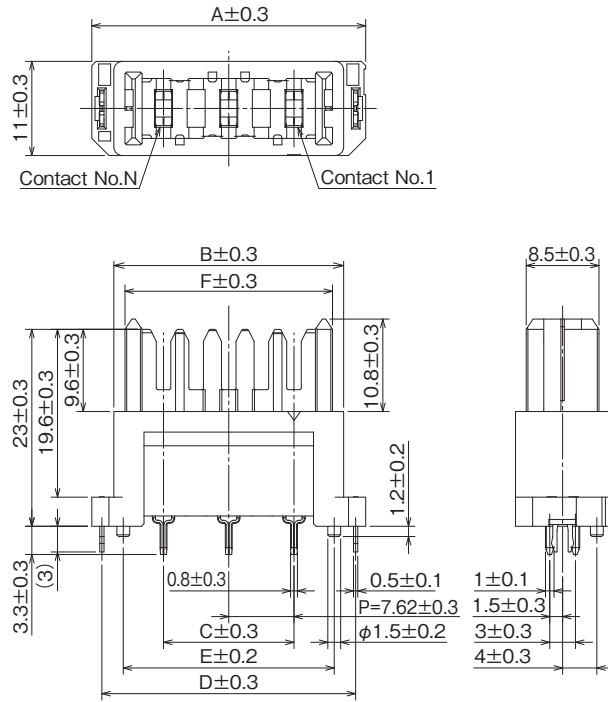

Unit : mm

Part No.	HRS No.	N (No. of Pos.)	A	B	C	D	E	F	Purchase Unit
FX30B-2P-7.62DSA30	CL0570-3304-3-00	2	24.37	19.22	7.62	22.02	17.02	16.62	42pcs per tray
FX30B-3P-7.62DSA30	CL0570-3305-6-00	3	31.99	26.84	15.24	29.64	24.64	24.24	35pcs per tray

### Recommended PCB Layout Dimensions

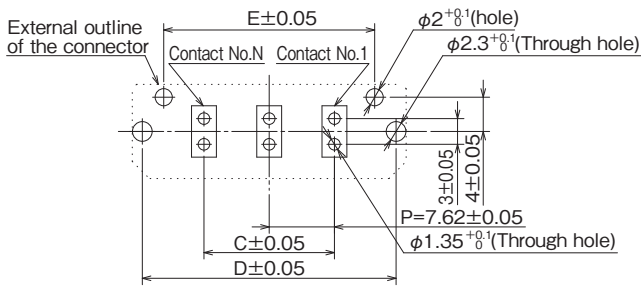

(Note) PCB thickness : t = 1.6mm

## Tray Packaging State Diagram

### Right Angle Receptacle (S-DS type)

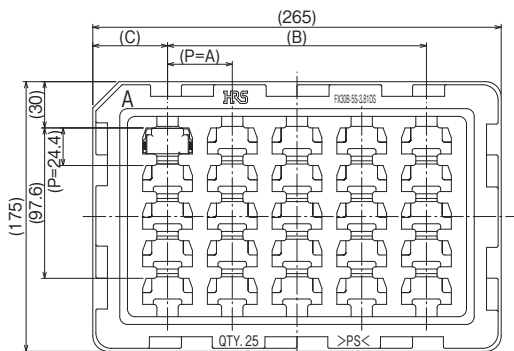

#### Normal Type

Unit : mm

Part No.	A	B	C	Quantity
FX30B-2S-3.81DS	30	180	42.5	35
FX30B-3S-3.81DS	35.5	177.5	43.75	30
FX30B-4S-3.81DS				
FX30B-5S-3.81DS	42	168	48.5	25

#### One Pin Skipped Type

Unit : mm

Part No.	A	B	C	Quantity
FX30B-2S-7.62DS	35.5	177.5	43.75	30
FX30B-3S-7.62DS	42	168	48.5	25

### Straight Receptacle (S-DSA type)

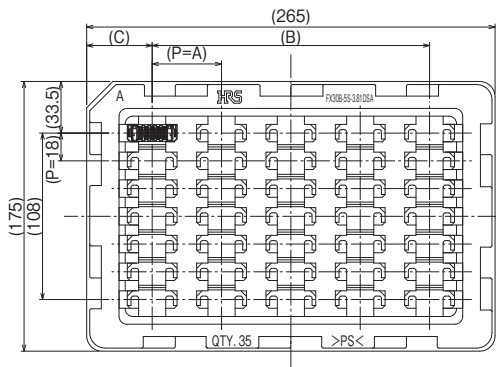

#### Normal Type

Unit : mm

Part No.	A	B	C	Quantity
FX30B-2S-3.81DSA	31.5	189	38	49
FX30B-3S-3.81DSA	38	190	37.5	42
FX30B-4S-3.81DSA	45	180	42.5	35
FX30B-5S-3.81DSA				

#### One Pin Skipped Type

Unit : mm

Part No.	A	B	C	Quantity
FX30B-2S-7.62DSA	38	190	37.5	42
FX30B-3S-7.62DSA	45	180	42.5	35

## Right Angle Header (P-DS type)

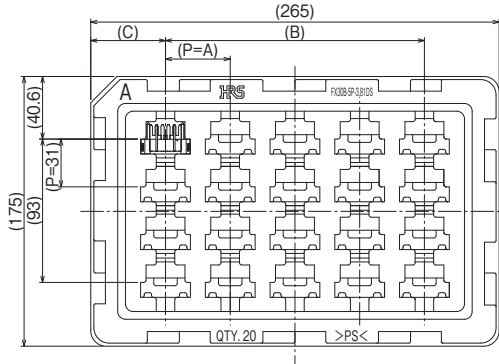

### Normal Type

Unit : mm

Part No.	A	B	C	Quantity
FX30B-2P-3.81DS	30	180	42.5	28
FX30B-3P-3.81DS	35.5	177.5	43.75	24
FX30B-4P-3.81DS				
FX30B-5P-3.81DS	42	168	48.5	20

### One Pin Skipped Type

Unit : mm

Part No.	A	B	C	Quantity
FX30B-2P-7.62DS	35.5	177.5	43.75	24
FX30B-3P-7.62DS	42	168	48.5	20

## Straight Header - ##(P-DSA## Type)

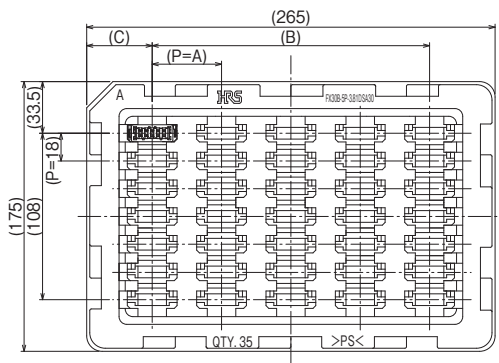

### Normal Type

Unit : mm

Part No.	A	B	C	Quantity
FX30B-2P-3.81DSA##	31.5	189	38	49
FX30B-3P-3.81DSA##	38	190	37.5	42
FX30B-4P-3.81DSA##	45	180	42.5	35
FX30B-5P-3.81DSA##				

### One Pin Skipped Type

Unit : mm

Part No.	A	B	C	Quantity
FX30B-2P-7.62DSA##	38	190	37.5	42
FX30B-3P-7.62DSA##	45	180	42.5	35

Note : The following illustration shows a tray form example. Please refer to "delivery specifications" for official individual forms.



## Cleaning Conditions

### ● Organic Solvent Cleaning

Solvent	Room temperature cleaning	Heated cleaning
IPA (Isopropyl alcohol)	○	○

### ● Water Cleaning

When using water cleaner (terpene, alkali saponifier, etc.), please select a cleaner according to the chart of effects to metal and resin issued by each cleaner manufacture. In addition, please make sure that the connectors are not left behind without removing moisture.

### ● Precautions for Cleaning

If flux or cleaner remains in the connector after it was cleaned using organic solvent or water cleaner, the performance of the connector may deteriorate. Make sure that the connectors are cleaned thoroughly.

## Usage Precautions

- A position misalignment absorption function is provided in this product. Please use this product within the dimensions shown in the below diagram, while taking into account the connector mounting position misalignments and PCB mating position misalignments.

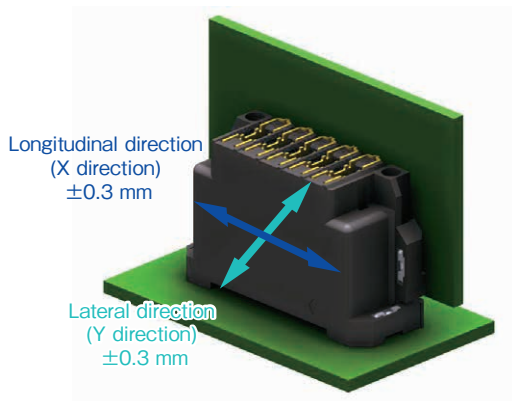

- The purpose of the position misalignment absorption function provided on this product is to absorb the misalignments between the connector mounting positions and between the PCB mating positions. **This function cannot be used for the purpose to absorb mating position misalignments due to vibrations.** Please use the connectors after the PCBs have been fixed so that the connector positions are fixed securely. Avoid supporting PCBs by connectors only, and be sure to fix the PCBs using methods other than the connectors.
- This connector is designed to correct minor mating misalignments. This ability creates a structure that allows more for more movement and shifting between its pieces than with other similar connectors. The PCB boards need to be secured as well. If they are not, vibration or other external forces will cause the connectors to become unmated.
- This product has a structure to absorb position misalignments by the spring displacement of the contacts in pitch directions. Therefore, **a spring reaction force will be generated in the pitch directions when absorbing the position misalignments** (Approximately 4 N per 1 core) Please make sure that the structure bodies (positioning pins, screws, guiding rails, and other connectors, etc.) that will be used as the positioning base have enough strength against the spring reaction force.
- Allowable Mating Gap  
The effective mating length of this product is 2mm.  
Use the connectors so that the gap between the header and receptacle when they are mated is within **1.0** or **1.3mm**. Particularly make sure the gap does not exceed the limits due to warping of PCB, etc.

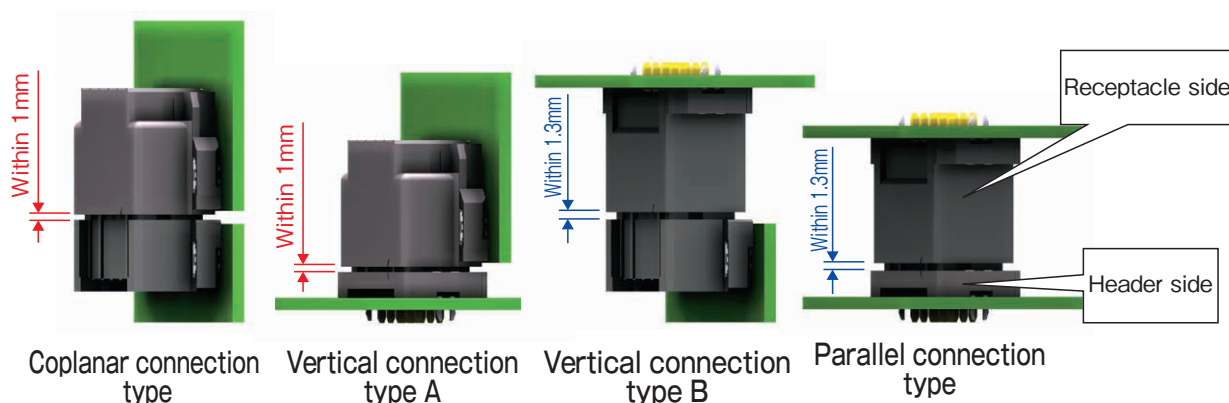

- A reverse insertion prevention structure and an abnormal mating position prevention structure have been provided in this connector, however, if the connectors are mated with an excessive force, connector breakage may result. Avoid improper mating of connectors by applying an excessive force and connect them correctly while confirming the connector polarities shown below.

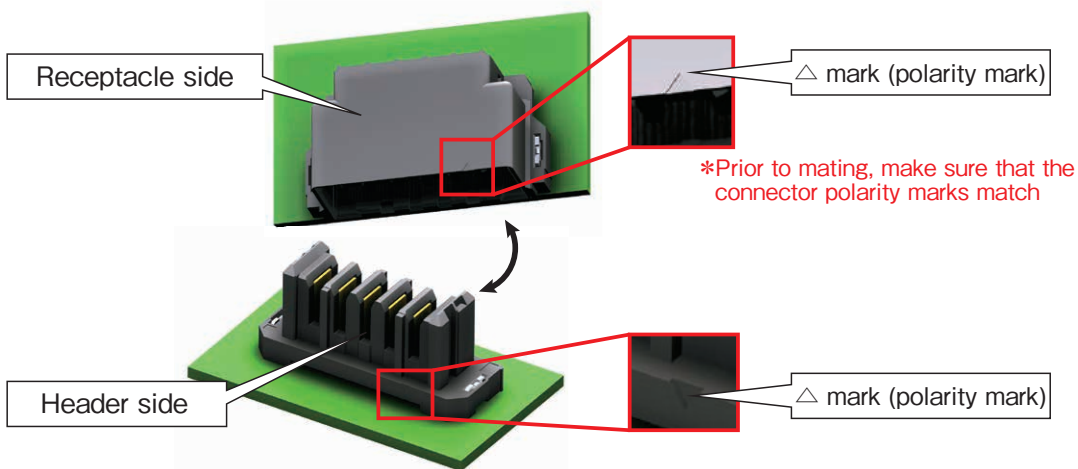

- A structure in which the contact deformation does not occur under normal mating operations has been provided on this connector, however, please make sure of the following; connector edge does not come to contact with the opening for mating, connectors are not mated diagonally in an abnormal manner, and foreign substances or hard objects, etc. do not touch the contacts. Pay attention so that contact deformation which causes a contact defect does not occur.



- If the connector is inserted/extracted forcibly in a wrong direction or it is rotated when inserting/extracting, a connector breakdown or contact defect may result. Please be careful.



- This product cannot be used for the purpose of current interruption application. (Prohibition of hot-swapping)

## While Taking into Consideration

Specifications mentioned in this catalogue are reference values.

While considering to order or to use this product, please confirm the "Drawing" and "Product Specifications" sheets.

While using connector with cable combination, please use appropriate cable.

If considering usage of inappropriate cable, please contact our sales representative.

If assembly process is done by jigs & tools which are not identified by our company, in such cases assurance will not be given.

If considering usage for below mentioned applications, please contact our sales representative.

As per condition, it needs to be considered whether assurance can be given or not.

In cases where the application will demand a high level of reliability, such as automotive, Medical instruments, Public infrastructure, aerospace/ defense etc.