

# Non-magnetic, Long-Life Connector

## MRF14 Series

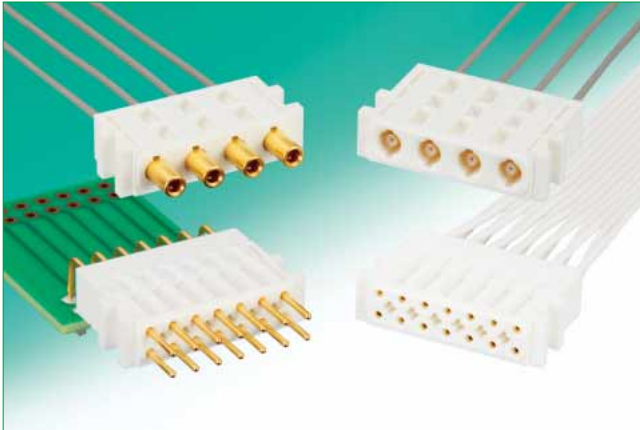

### ■ Summary

The MRF14 Series is a non-magnetic long-life connector.

With excellent mating durability (60,000 cycles for both coaxial and signal contacts) it is a suitable interface connector suitable for use in a variety of MRI and testing equipment.

### ■ Features

#### <Both Coaxial and Signal>

- Non-magnetic
- Long life (60,000 times)
- Complaint with RoHS

#### <Coaxial>

##### 1. Impedance Matching

High Frequency Characteristics : DC to 0.5GHz, V.S.W.R. 1.3 Max., 0.5 to 1GHz, V.S.W.R. 1.5 Max.

##### 2. Small Diameter

Both the plug and jack have a small outer diameter of only  $\phi 3.84\text{mm}$ .

##### 3. Plug-in Mating, Low Insertion and Removal Force

Plug-in mating for easy insertion and removal. Insertion force of 1.5N or less per pin and extraction force of 0.15N or more.

##### 4. Applicable cable

Outer diameter  $\phi 1.37$  flexible coaxial cable

##### 5. Housing

4pin housing (Plug, Jack)

#### <Signal>

##### 1. Small and light

Male (terminal) :  $\phi 2.09\text{mm}$  outer diameter, 0.35g-0.62g weight per pin

Female (terminal) :  $\phi 2.04\text{mm}$ , 0.18g per pin for reducing the size and weight of the interface.

##### 2. DIP type, Cable harness type

The male (terminal) is a Light angle DIP type, the female (terminal) is a cable harness type.

##### 3. Housing

14 pin housing (same for male and female)

## ■ Mounted Connector Diagram

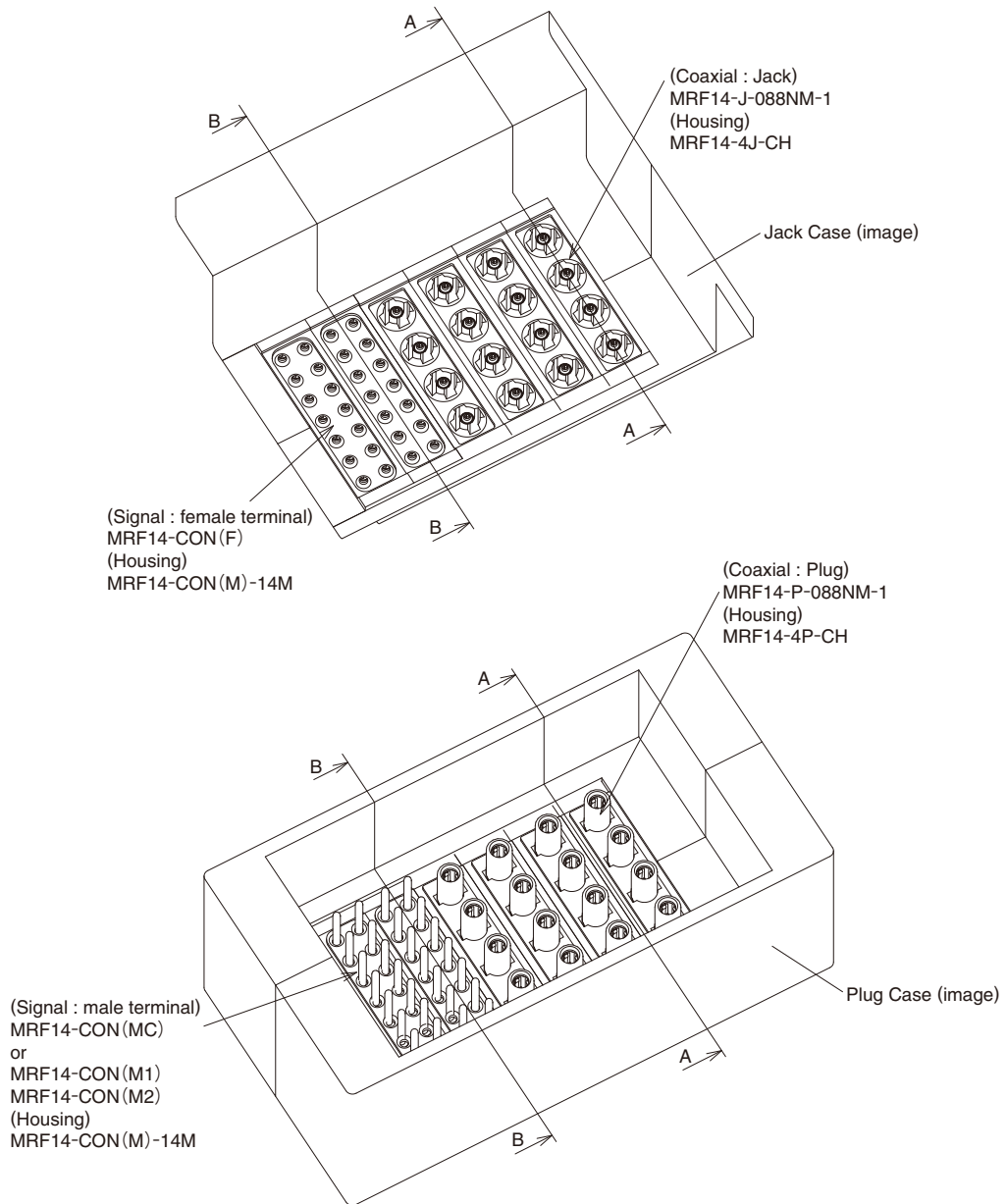

※ Lock and guide pin are purchased separately. Contact a Hirose sales representative for installation details and dimensions.

# Functional Diagram

## <Coaxial>

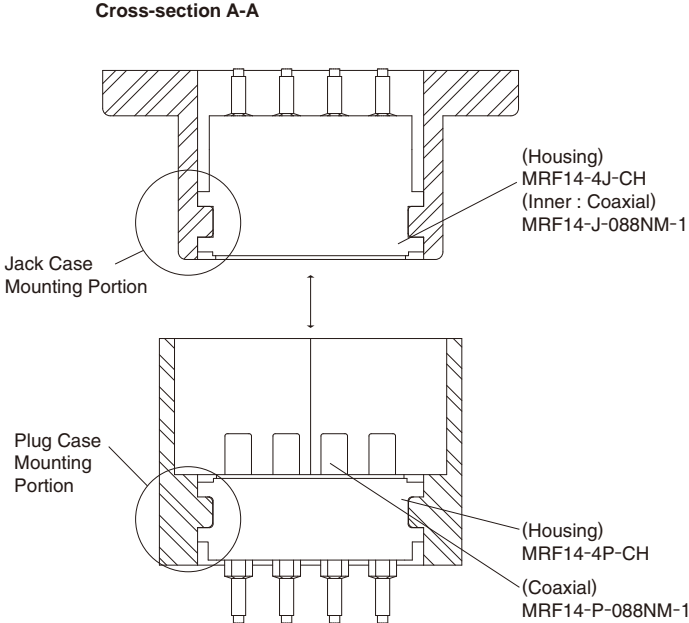

## <Signal>

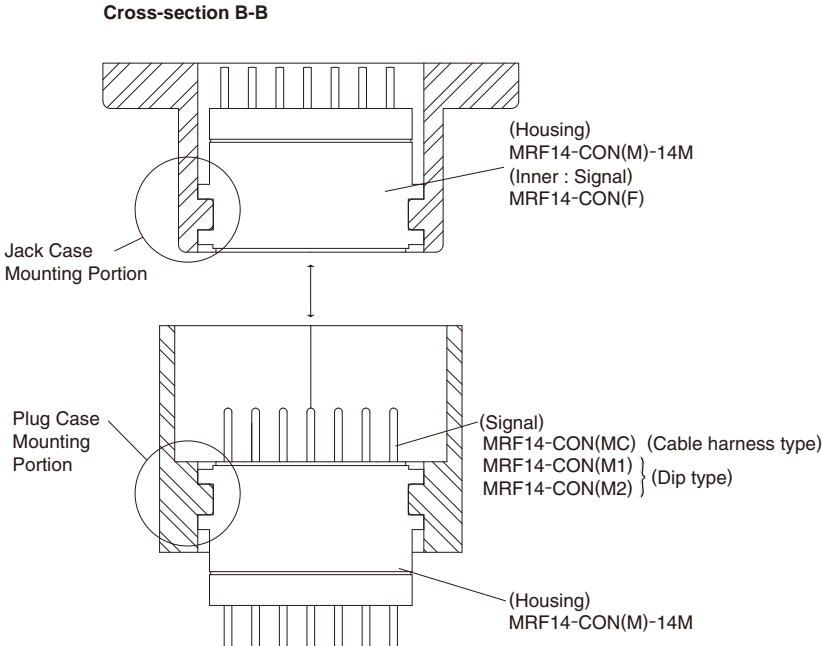

Dec.1.2021 Copyright 2021 HIROSE ELECTRIC CO., LTD. All Rights Reserved.

## ■ Cable Type

Part No.	Applicable Cable
MRF14-P-088NM-1	φ1.37 flexible coaxial cable
MRF14-J-088NM-1	φ1.37 flexible coaxial cable
MRF14-CON (MC)	24 AWG
MRF14-CON (F)	24 AWG

### [Coaxial]

## ■ Product Specifications

Ratings	Nominal Characteristic Impedance	50Ω	Operating Temperature	-40°C to +85°C
	Frequency	DC to 1GHz	Operating Humidity	90% RH or less

Item	Specifications	Conditions
1. Contact Resistance	30mΩ Max. (Center) 30mΩ Max. (Outer)	Measured at less than 100mA
2. Insulation Resistance	500MΩ Min.	Measured at 500V DC
3. Withstanding Voltage	No flashover or breakdown	500V AC for 1 min.
4. V.S.W.R.	1.3 Max. 1.5 Max.	DC to 0.5GHz 0.5 to 1GHz
5. Retention Force of Female Contact	0.05N Min.	Measured with φ0.4826 steel pin
6. Total Insertion and Extraction Force	Insertion force 1.5N Max. Extraction force 0.15N Min.	Measured with applicable connector.
7. Mating Cycles	Contact Resistance 60mΩ Max. (Center) 60mΩ Max. (Outer) No broken, cracked or loose parts.	60,000 cycles
8. Vibration Resistance	No electrical discontinuity for 1μs or more. No broken, cracked or loose parts.	Frequency 10 to 500Hz, Half Amplitude 0.75mm, Acceleration 98m/s <sup>2</sup> 10 cycles in 3 axial directions
9. Shock Resistance	No electrical discontinuity for 1μs or more. No broken, cracked or loose parts.	Acceleration 735m/s <sup>2</sup> , Duration 6ms, Wave form half-sine wave, 3 times in 3 axial directions
10. Damp Heat	Insulation Resistance 10MΩ Min. (in high humidity environment) Insulation Resistance 500MΩ Min. (in dry environment) No broken, cracked or loose parts.	Left at +40°C and 95% RH for 96 hours
11. Temperature Cycles	No broken, cracked or loose parts.	Temperature : -55°C→20 to 35°C→+85°C→20 to 35°C Time : 30min. → 3min. → 30min. → 3min. Cycles : 5
12. Salt Spray	No considerable corrosion	Continuous 48 hour cycle in 5% salt water solution

## ■ Materials / Finish

Part	Material	Finish
Shell	Phosphor Bronze	Gold plated
Center Female Contact	Beryllium Copper	Gold plated
Center Male Contact	Phosphor Bronze	Gold plated
Insulator	PTEE	————
Crimp Sleeve	Phosphor Bronze	Non-magnetic nickel plating
Heat Shrink Tube	Polyolefin	————
Housing	PBT	————

## Product Number Structure

Refer to the chart below when determining the product specifications from the product number.  
Please select from the product numbers listed in this catalog when placing orders.

**MRF14** - [ ] - **088 NM** - **1**

①                      ②                      ③

① Series Name : MRF14
② Connector Type P : Straight Plug J : Straight Jack
③ Applicable Cable 088 : $\phi$ 1.37 Flexible Coaxial Cable

### Straight Plug

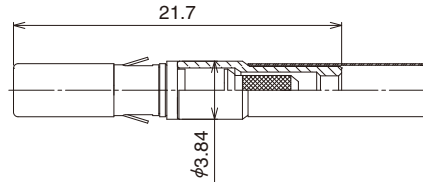

Part No.	HRS No.	RoHS
MRF14-P-088NM-1	313-0714-8	○

### Straight Jack

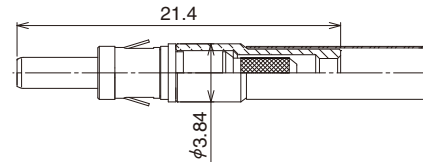

Part No.	HRS No.	RoHS
MRF14-J-088NM-1	313-0715-0	○

### Housing (4pos., for plug)

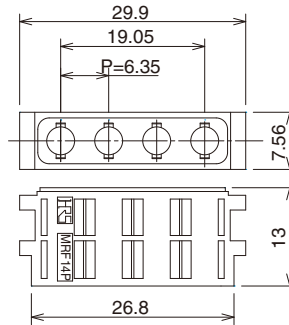

Part No.	HRS No.	RoHS
MRF14-4P-CH	313-0707-2	○

### Housing (4pos., for jack)

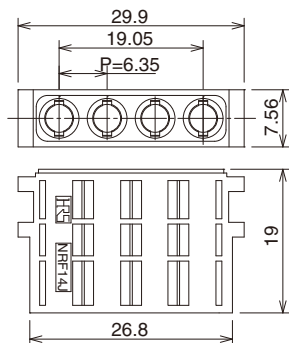

Part No.	HRS No.	RoHS
MRF14-4J-CH	313-0708-5	○

[Signal]

■ Product Specifications

Rated Voltage	500V AC	Operating Temperature	-40°C to +85°C
Rated Current	2A DC	Operating Humidity	90% RH or less

Item	Specifications	Conditions
1. Contact Resistance	30mΩ Max.	Measured at less than 100mA
2. Insulation Resistance (※)	500MΩ Min.	Measured at 500V DC
3. Withstanding Voltage (※)	No flashover or breakdown	1,500V AC for 1 min.
4. Retention Force of Female Contact	0.02N Min.	Measured with applicable connector
5. Mating Cycles	Contact Resistance 60mΩ Max. No broken, cracked or loose parts	60,000 cycles
6. Vibration Resistance	No electrical discontinuity for 1μs or more. No broken, cracked or loose parts	Frequency 10 to 500Hz, Half Amplitude 0.75mm, Acceleration 98m/s <sup>2</sup> 10 cycles in 3 axial directions
7. Shock Resistance	No electrical discontinuity for 1μs or more. No broken, cracked or loose parts.	Acceleration 735m/s <sup>2</sup> , Duration 6ms, Wave form half-sine wave, 3 times in 3 axial directions
8. Damp Heat	Insulation Resistance 10MΩ Min. (in high humidity environment) Insulation Resistance 500MΩ Min. (in dry environment) No broken, cracked or loose parts	Left at +40°C and 95% RH for 96 hours
9. Temperature Cycle	No broken, cracked or loose parts	Temperature : -40°C→20 to 35°C→+85°C→20 to 35°C Time : 30min. → 3min. → 30min. → 3min. Cycles : 5
10. Salt Spray	No considerable corrosion	Continuous 48 hour cycle in 5% salt water solution

※Measured when mounted in housing.

■ Materials / Finish

Part	Material	Finish
Terminal	Beryllium Copper	Gold plated
Outer Shell	Phosphor Bronze	Gold plated
Male Contact	Beryllium Copper or Phosphor Bronze	Gold plated
Female Contact	Beryllium Copper	Gold plated
Housing	PBT	—

■ Product Number Structure

Refer to the chart below when determining the product specifications from the product number.  
Please select from the product numbers listed in this catalog when placing orders.

**MRF14 - CON ( Γ J )**

①                      ②                      ③

① Series Name : MRF14
② CON : Signal Connector
③ Connector Type MC : Male (Cable Harness type) M1, M2 : Male (DIP type) F : Female (Cable Harness type)
Applicable Cable 24 AWG

Dec.1.2021 Copyright 2021 HIROSE ELECTRIC CO., LTD. All Rights Reserved.

### Male Contact (Cable Harness Type)

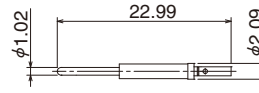

Part No.	HRS No.	RoHS
MRF14-CON(MC)	313-0716-3	○

### Male Contact (DIP Type)

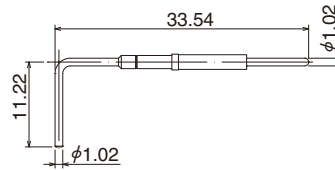

Part No.	HRS No.	RoHS
MRF14-CON(M1)	313-0710-7	○

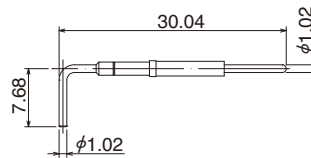

Part No.	HRS No.	RoHS
MRF14-CON(M2)	313-0711-0	○

### Female Contact (Cable Harness Type)

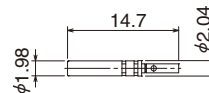

Part No.	HRS No.	RoHS
MRF14-CON(F)	313-0709-8	○

### Housing (14pos., Same for both male and female contacts)

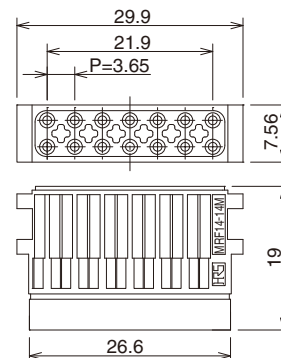

Part No.	HRS No.	RoHS
MRF14-CON(M)-14M	313-0706-0	○

### ◆ Male Contact (DIP Type) Mounted in Housing

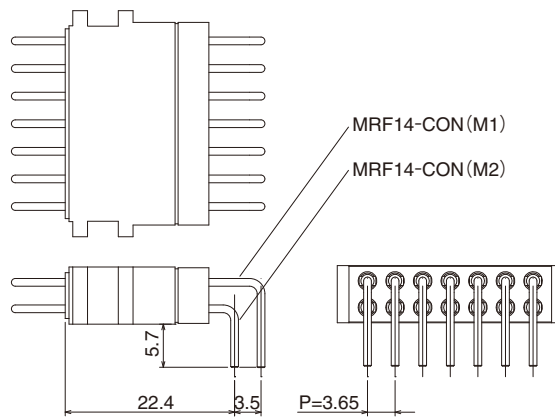

### ◆ Board Hole Dimensions (Male Contact DIP Type)

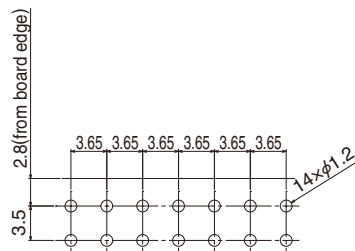

### ◆ Applicable Tool

Item	Part No.	Applicable Connector
Cable Crimping Tool	HT702/MRF14-088	MRF14-P-088NM-1
		MRF14-J-088NM-1
	HT901/MRF14-CON	MRF14-CON (MC)
		MRF14-CON (F)



**HIROSE ELECTRIC CO.,LTD.**

2-6-3,Nakagawa Chuoh,Tsuzuki-Ku,Yokohama-Shi 224-8540,JAPAN

TEL: +81-45-620-3526 Fax: +81-45-591-3726

<http://www.hirose.com>

<http://www.hirose-connectors.com>