

## MRF14 Series

# Non-Magnetic, Long-Life Connector

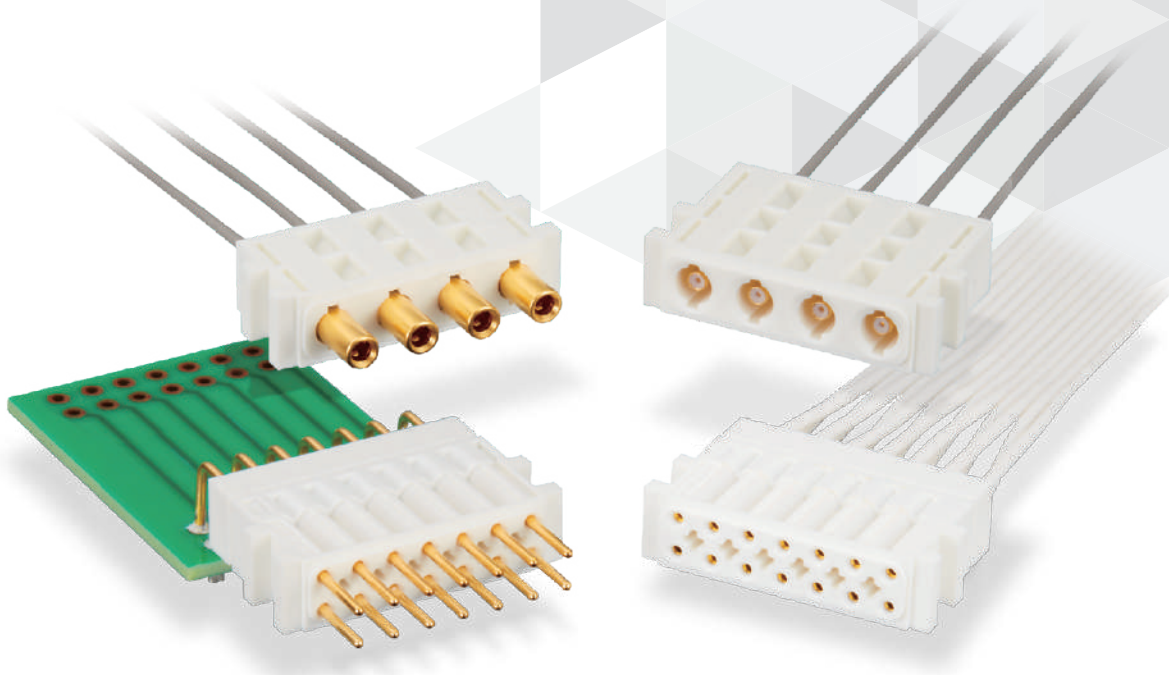

Apr. 1. 2024 Copyright 2024 HIROSE ELECTRIC CO., LTD. All Rights Reserved.



## Overview

MRF14 Series is a non-magnetic, long-life connector designed for MRI and testing equipment. With its excellent mating durability of 60,000 times, this multi-positional connector is suitable for various applications. Both coaxial and signal types are available.

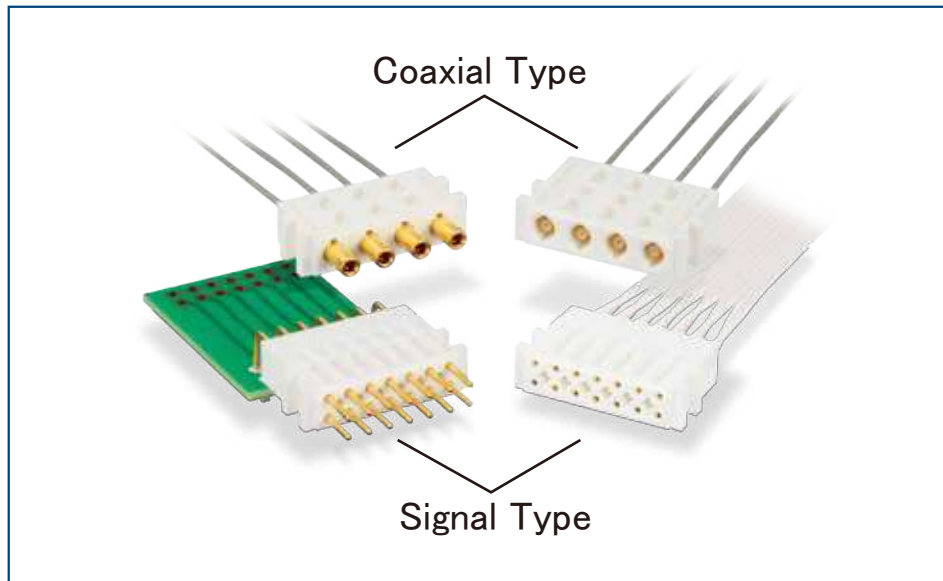

## Features

### ● Whole Series

1. Non-Magnetic
2. Long-Life  
(Mating Durability : 60,000 times)

### ● Coaxial Type

#### 1. Available in 4, 8pos. Housing

4, 8pos. Housings for plugs and jacks are sold separately.

#### 2. High Impedance Matching

Excellent High Frequency Characteristics :  
Up to 0.5GHz, V.S.W.R. 1.3 Max.  
0.5 to 1GHz, V.S.W.R. 1.5 Max.

### 3. Easy Insertion and Removal, Low Insertion and Removal Force

Plug-in mating for easy insertion and removal.  
Insertion force of 1.5N Max. and extraction force  
of 0.15N Min. per pin.

## ● Signal Type

### 1. 14pos. Housing

14 pos. Housing (same for Male and Female) is  
sold separately.

### 2. Compact and Lightweight Design

Male Contact: 2.09mm outer diameter,  
approximately 0.35 to 0.62g per pin.  
Female Contact: 2.04mm outer diameter,  
approximately 0.18g per pin.

### 3. Support for Through-Hole Mounting and In-Line Cable Harness

The male contact supports right-angle through-  
hole mounting and in-line cable harnessing.  
The female contact is designed for in-line cable  
harnessing.

## Product Specifications

### ● Coaxial Type

|                          |             |                             |              |
|--------------------------|-------------|-----------------------------|--------------|
| Characteristic Impedance | 50 $\Omega$ | Operating Temperature       | -40 to +85°C |
| Frequency                | 0 to 1GHz   | Operating Relative Humidity | 90% Max.     |

| Item                              | Standards  | Condition   |
|-----------------------------------|--|---|
| Contact Resistance                | 30m $\Omega$ Max. (Center)<br>30m $\Omega$ Max. (External)   | Measured at 100mA Max.  |
| Insulation Resistance             | 500M $\Omega$ Min.   | Measured at 500V DC   |
| Withstanding Voltage              | No dielectric breakdown  | 500V AC for 1 min.  |
| V.S.W.R.                          | 1.3 Max.<br>1.5 Max.   | 0 to 0.5GHz<br>0.5 to 1GHz  |
| Retention Force of Female Contact | 0.05N Min.   | Measured with $\phi$ 0.4826 steel pins  |
| Insertion/Extraction Force        | Insertion Force : 1.5N Max.<br>Extraction Force 0.15N Min.   | Measure with a compatible connector.  |
| Mating Durability                 | Contact Resistance :<br>60m $\Omega$ Max. (Center)<br>60m $\Omega$ Max. (External)<br>No broken, cracked, or loose parts.  | 60,000 times  |
| Vibration Resistance              | No electrical discontinuity of 1 $\mu$ s or more<br>No broken, cracked, or loose parts.  | Frequency 10 to 500Hz, Half amplitude 0.75mm,<br>Acceleration 98m/s <sup>2</sup><br>10 cycles in each of the 3 axis                       |
| Humidity Resistance               | Insulation Resistance :<br>10M $\Omega$ Min. (in a high humidity environment)<br>Insulation Resistance :<br>500M $\Omega$ Min. (in a dry environment)<br>No broken, cracked, or loose parts. | Temperature +40°C , Humidity 95%, Left for 96 hours   |
| Temperature Cycle                 | No broken, cracked, or loose parts.  | Temperature: -55°C to +20 to +35°C to +85°C to +20 to +35°C<br>Time: 30 min. -- > within 5 min. -- > 30 min. -> within 5 min.<br>5 cycles |
| Salt Spray                        | No considerable corrosion.   | Continuous 48 hour cycle in 5% salt water solution  |

Note: Information contained in this catalog represents general requirements for this Series.  
Contact us for the drawings and specifications for a specific part number shown.

## ● Signal Type

|               |         |                             |              |
|---------------|---------|-----------------------------|--------------|
| Rated Current | 2A DC   | Operating Temperature       | -40 to +85°C |
| Rated Voltage | 500V AC | Operating Relative Humidity | 90% Max.     |

| Item                           | Standards  | Condition   |
|--------------------------------|--|---|
| Contact Resistance             | 30m Ω Max.   | Measured at 100mA Max.  |
| Insulation Resistance (Note)   | 500M Ω Min.  | Measured at 500V DC   |
| Withstanding Voltage (Note)    | No dielectric breakdown  | 1,500V AC for 1 min.  |
| Female Contact Retention Force | 0.02N Min.   | Measured with applicable connector  |
| Mating Durability              | Contact Resistance : 60m Ω Max.<br>No broken, cracked, or loose parts.   | 60,000 times  |
| Vibration Resistance           | No electrical discontinuity of 1 μ s or more<br>No broken, cracked, or loose parts.  | Frequency 10 to 500Hz, Half amplitude 0.75mm,<br>Acceleration 98m/s <sup>2</sup><br>10 cycles in each of the 3 axis             |
| Humidity Resistance            | Insulation Resistance :<br>10M Ω Min. (in a high humidity environment)<br>Insulation Resistance :<br>500M Ω Min. (in a dry environment)<br>No broken, cracked, or loose parts. | Temperature +40°C , Humidity 95%, Left for 96 hours   |
| Temperature Cycle              | No broken, cracked, or loose parts.  | Temperature: -55°C → +20 to +35°C → +85°C → +20 to +35°C<br>Time: 30 min. → within 5 min. → 30 min. → within 5 min.<br>5 cycles |
| Salt Spray                     | No considerable corrosion.   | Continuous 48 hour cycle in 5% salt water solution.   |

Note 1 : Measured when mounted in housing.

Note 2 : Information contained in this catalog represents general requirements for this Series.  
Contact us for the drawings and specifications for a specific part number shown.

## Materials / Finish

### ● Coaxial Type

| Component             | Material           | Finish                      |
|-----------------------|--------------------|-----------------------------|
| Shell                 | Phosphorous Bronze | Gold Plating                |
| Center Male Contact   | Phosphorous Bronze | Gold Plating                |
| Center Female Contact | Beryllium Copper   | Gold Plating                |
| Insulator             | PTFE               | -                           |
| Crimp Sleeve          | Phosphorous Bronze | Non-Magnetic Nickel Plating |
| Heat Shrink Tube      | Polyolefin         | -                           |
| Housing               | PBT                | -                           |

### ● Signal Type

| Component      | Material                               | Finish       |
|----------------|--|--------------|
| Contact        | Beryllium Copper                       | Gold Plating |
| Outer Tube     | Phosphorous Bronze                     | Gold Plating |
| Male Contact   | Beryllium Copper<br>Phosphorous Bronze | Gold Plating |
| Female Contact | Beryllium Copper                       | Gold Plating |
| Housing        | PBT                                    | -            |

## Product Number Structure

Refer to the chart below when determining the product specifications from the product number.  
Please select from the product numbers listed in this catalog when placing orders.

### ■ Coaxial Type

**MRF14 - [ ] - 088 NM - 1**

①      ②      ③

|                  |  |                    |  |
|------------------|--|--------------------|--|
| ① Series Name    | MRF14                                  | ③ Compatible Cable | 088 : $\phi$ 1.37 Flexible Coaxial Cable |
| ② Connector Type | P : Straight Plug<br>J : Straight Jack |                    |  |

### ■ Signal Type

**MRF14 - CON ( [ ] )**

①      ②      ③

|               |                |                    |  |
|---------------|----------------|--------------------|--|
| ① Series Name | MRF14          | ③ Connector Type   | MC :<br>Male (In-Line Cable Harness Type)<br>M1, M2 :<br>Male (Through-Hole Mounting Type)<br>F :<br>Female (In-Line Cable Harness Type) |
| ② CON         | Signal Contact |                    |  |
|               |                | ④ Compatible Cable | 24 AWG   |

## Functional Diagram

### ● Coaxial Type

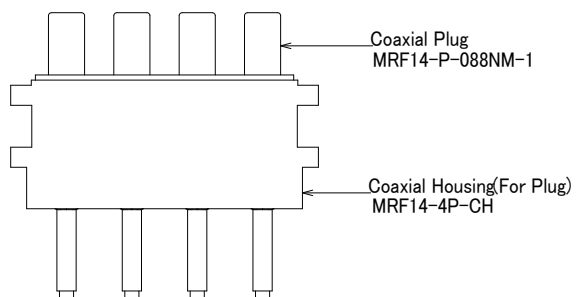
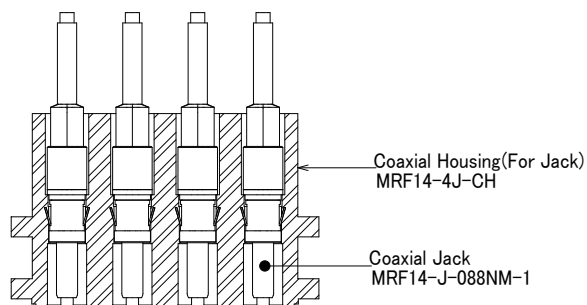

Note : Coaxial housing is also available for 8pos.

### ● Signal Type

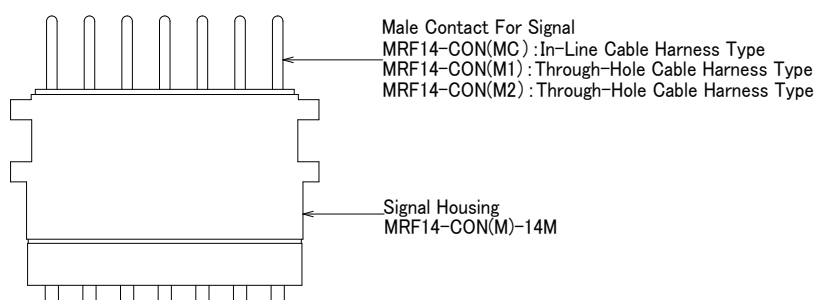
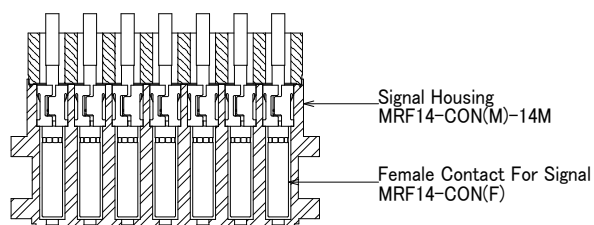

## Coaxial Straight Plug

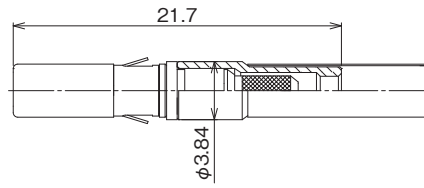

| Part No.        | HRS No.          | Purchase Unit |
|-----------------|------------------|---------------|
| MRF14-P-088NM-1 | CL0313-0714-8-00 | 20pcs per bag |

## Coaxial Straight Jack

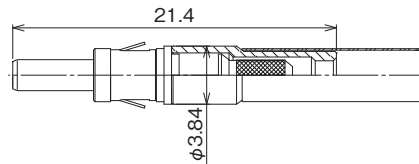

| Part No.        | HRS No.          | Purchase Unit |
|-----------------|------------------|---------------|
| MRF14-J-088NM-1 | CL0313-0715-0-00 | 20pcs per bag |

## Coaxial Housing (for 4pos. Coaxial Plug)

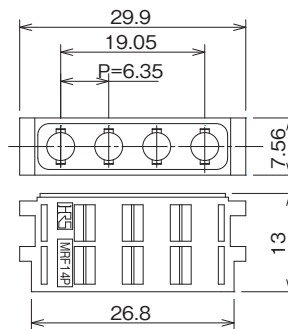

| Part No.    | HRS No.          | Purchase Unit |
|-------------|------------------|---------------|
| MRF14-4P-CH | CL0313-0707-2-00 | 20pcs per bag |



### Coaxial Housing (for 4pos. Coaxial Jack)

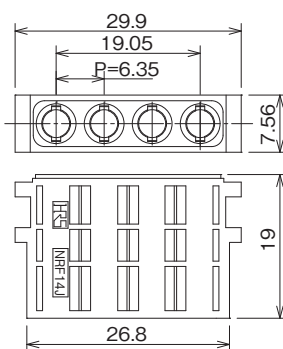

| Part No.    | HRS No.          | Part No.      |
|-------------|------------------|---------------|
| MRF14-4J-CH | CL0313-0708-5-00 | 20pcs per bag |

### Coaxial Housing (for 8pos. Plug)

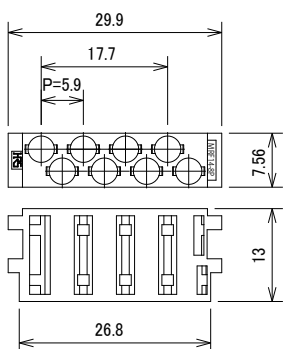

| Part No.    | HRS No.          | Purchase Unit |
|-------------|------------------|---------------|
| MRF14-8P-CH | CL0313-0721-3-00 | 20pcs per bag |

### Coaxial Housing (for 8pos. Jack)

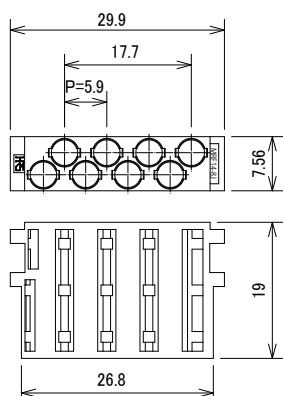

| Part No.    | HRS No.          | Purchase Unit |
|-------------|------------------|---------------|
| MRF14-8J-CH | CL0313-0722-6-00 | 20pcs per bag |

## Signal Male Contact (In-Line Cable Harness Type)

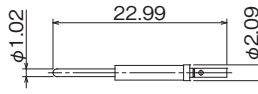

| Part No.      | HRS No.          | Purchase Unit |
|---------------|------------------|---------------|
| MRF14-CON(MC) | CL0313-0716-3-00 | 20pcs per bag |

## Signal Male Contact (Through-Hole Mounting Type)

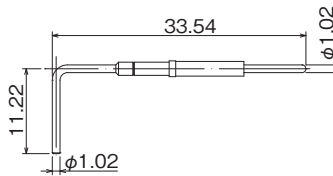
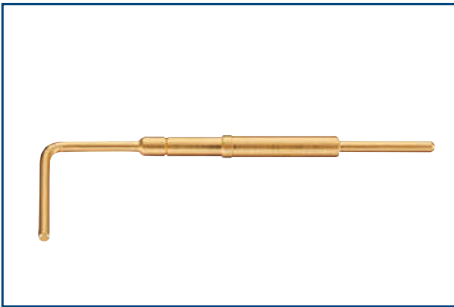

| Part No.      | HRS No.          | Purchase Unit |
|---------------|------------------|---------------|
| MRF14-CON(M1) | CL0313-0710-7-00 | 20pcs per bag |

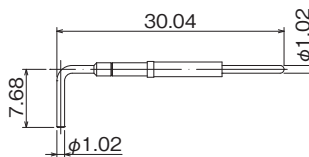

| Part No.      | HRS No.          | Purchase Unit |
|---------------|------------------|---------------|
| MRF14-CON(M2) | CL0313-0711-0-00 | 20pcs per bag |

## Signal Female Contact (In-Line Cable Harness Type)

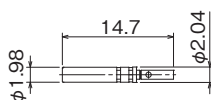

| Part No.     | HRS No.          | Part No.      |
|--------------|------------------|---------------|
| MRF14-CON(F) | CL0313-0709-8-00 | 20pcs per bag |

## Housing (For Signal, 14pos. Both Male and Female)

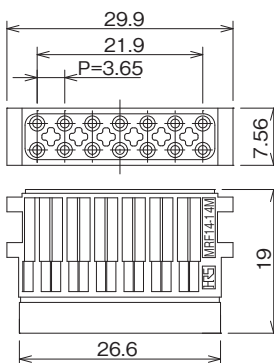

| Part No.         | HRS No.          | Purchase Unit |
|------------------|------------------|---------------|
| MRF14-CON(M)-14M | CL0313-0706-0-00 | 10pcs per box |

### Male Contact (Through-Hole Mounting Type)

### PCB Hole Dimensions (Male Contact Through-Hole Mounting Type)

Mounted in Housing

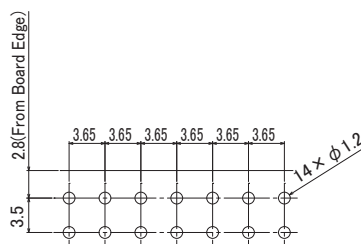
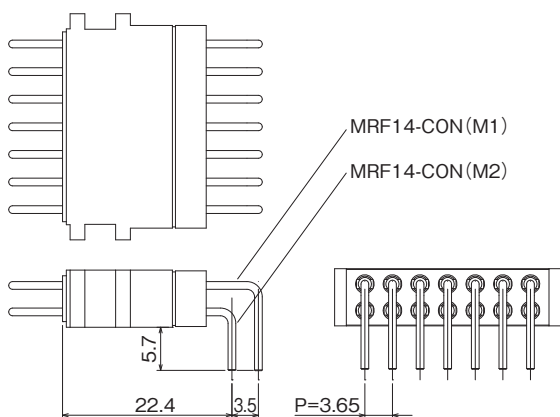

# Mounted Connector Diagram

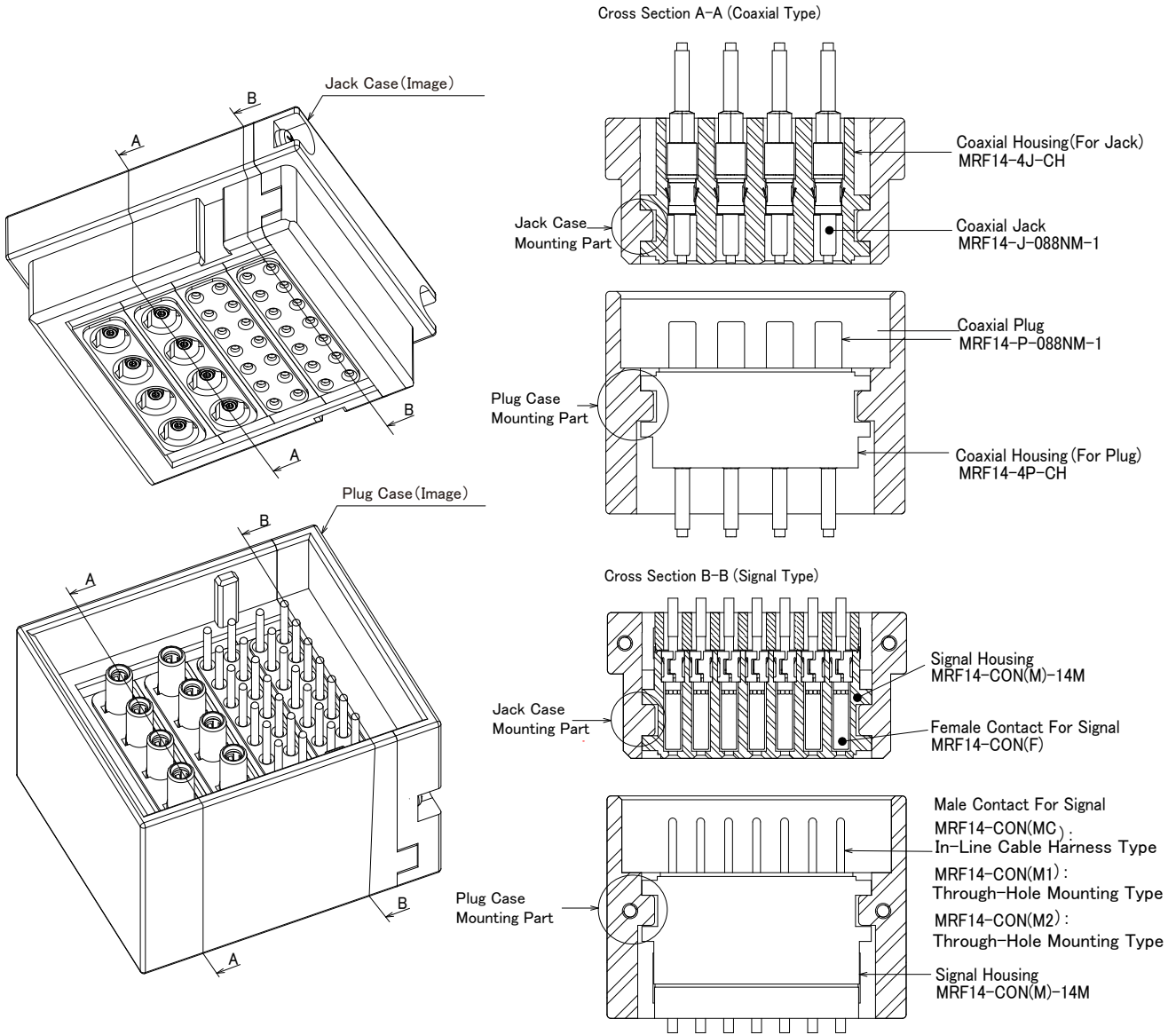

Note : Lock and guide pin are purchased separately. Contact a Hirose sales representative for installation details and dimensions.

## Cable Type

| Part No.        | Compatible Cable              |
|-----------------|-------------------------------|
| MRF14-P-088NM-1 | φ 1.37 Flexible Coaxial Cable |
| MRF14-J-088NM-1 | φ 1.37 Flexible Coaxial Cable |
| MRF14-CON(MC)   | 24 AWG                        |
| MRF14-CON(F)    | 24 AWG                        |

## Applicable Tool

| Item                | Part No.        | Compatible Connector |
|---------------------|-----------------|----------------------|
| Cable Crimping Tool | HT702/MRF14-088 | MRF14-P-088NM-1      |
|                     |                 | MRF14-J-088NM-1      |
|                     | HT901/MRF14-CON | MRF14-CON(MC)        |
|                     |                 | MRF14-CON(F)         |

## While Taking into Consideration

Specifications mentioned in this catalog are reference values.

When considering to order or use this product, please review the Drawing and Product Specifications sheets.

Use an appropriate cable when using the connector in combination with cables.

If considering usage of a non-specified cable, please contact your sales representative.

If assembly process is done by jigs & tools which are not identified by Hirose, the warranty of the product may be affected.

If considering usage for below mentioned applications, please contact your sales representative.

In cases where the application will demand a high level of reliability, such as automotive, medical instruments, public infrastructure, aerospace/defense etc. Hirose must review before assurance of reliability can be given.

**HIROSE**



**HIROSE ELECTRIC CO.,LTD.**

2-6-3 Nakagawa Chuoh, Tsuzuki-Ku, Yokohama-Shi 224-8540, JAPAN  
<https://www.hirose.com>