

QR/P1 Series

Small, Rectangular, High Pin Count, Rack and Panel Crimp Connector



Multiple Position



Floating

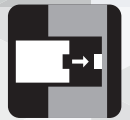

Plug-In

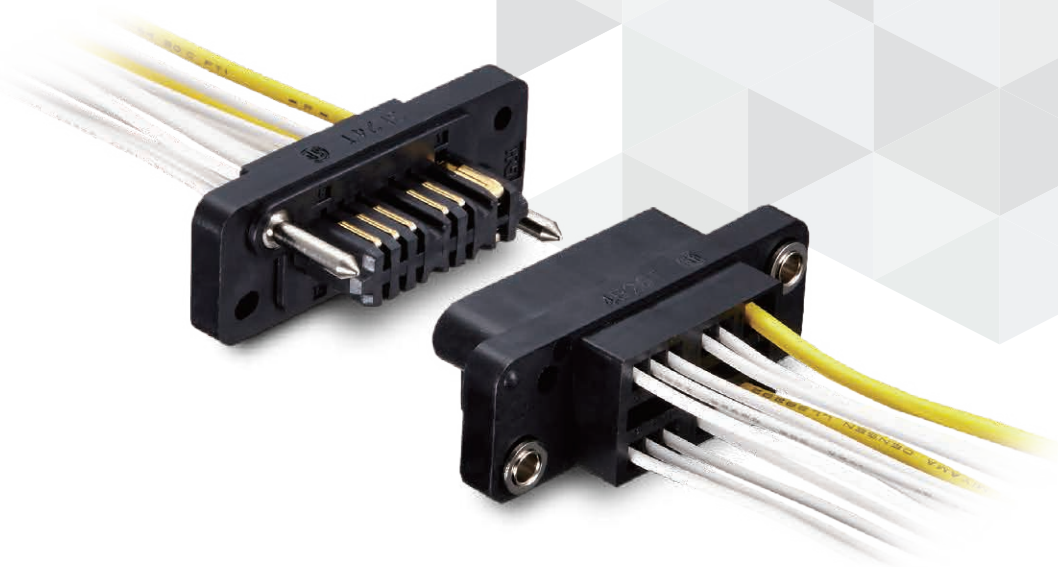

Apr. 1. 2024 Copyright 2024 HIROSE ELECTRIC CO., LTD. All Rights Reserved.



Overview

The QR/P1 Series is a more compact version of the rectangular, multi-pin count and plug-in connection QR/P Series for racks and panels, which has been well received in the market. The QR/P1 Series is a compact rack and panel connector that enables even higher density mounting.

Five different pin counts are available: 8, 12, 16, 24, and 32. Wire connection is performed using crimp termination for easier workability and high reliability.

Features

1. Plug-in Design

The plug-in design enables a large effective mating length.

2. Floating bushing enables a floating design.

3. UL, CSA, TÜV certified.

Product Specifications

Rated Current	Power	13A Max. (When using 14 AWG)	Operating Temperature	-10 to +60°C
	Signal	3A		
Rated Voltage	Power	250V AC		
	Signal	125V AC		

Item	Specifications	Conditions
Contact Resistance	Power Contact : 10mΩ Max. Signal Contact : 15mΩ Max.	Measured at 1A DC
Insulation Resistance	5000MΩ Min.	Measured at 500V DC
Withstanding Voltage	No flashover or insulation breakdown	Power : 1000V AC for 1 min. Signal : 500V AC for 1 min.

Safety Standard		UL		CSA		TÜV
Operating Temperature		-10 to +60°C				
Rated Voltage	Power	120V AC	250V AC	125V AC	250V AC	250V AC, 300V DC
	Signal					125V AC, 150V DC
Rated Current	14 AWG	10A	3A	10A	3A	10A
	16 AWG			8A		
	18 AWG	3A	1A	3A	1A	5A
	20 AWG					2.5A
	22 AWG	2A	1A	2A	1A	1A
	24 AWG					
		Signal	1A	0.5A	1A	
	26 AWG	1A	0.5A	1A	0.5A	
28 AWG						

Material / Finish

Item	Material	Color/Finish	Remarks
Insulator	PBT	Black	UL94V-0
Contact	Phosphor Bronze	Partial Gold Plating (Nickel Underplating)	—

Product Number Structure

Refer to the chart below when determining the product specifications from the product number.
Please select from the product numbers listed in this catalog when placing orders.

Connector Unit

QR/P1 - 12 P - C (21)

① ② ③ ④ ⑪

Contact

QR/P1 - PC 1 A - 1 1 1

① ⑤ ⑥ ⑦ ⑧ ⑨ ⑩

① Series Name	QR/P1	⑦ Size of Barrel	A : For Thin Cable B : For Thick Cable
② No. of Pos.	8,12,16,24,32 pos.	⑧ Contact Type	1 : Loose Piece Contact 2 : Reel Contact
③ Insulator Gender	P : Male Insulation Case S : Female Insulation Case	⑨ Applicable Cable	(Power Contact) 1 : 18 to 24 AWG 2 : 14 to 16 AWG (Signal Contact) 1 : 24 to 28 AWG 2 : 20 to 24 AWG
④ Contact Connection Method	C : Crimp Connection		
⑤ Terminal Shape Symbol	PC : Male Crimp Contact SC : Female Crimp Contact	⑩ Surface Treatment	1 : Partial Gold Plating (Nickel Underplating)
⑥ Contact Type	1 : Power Contact 2 : Signal Contact	⑪ Specification	(21) : UL, CSA, TÜV

Housing

Male Housing

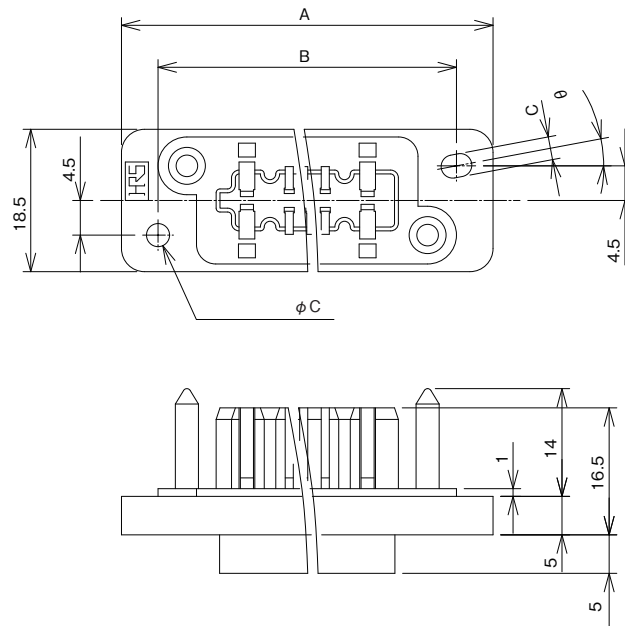

Unit : mm

Part No.	HRS No.	No. of Pos.	A	B	C	θ	Purchase Unit
QR/P1-8P-C(21)	CL0221-0124-0-21	8	46.4	36.9	3.0	13.4°	50pcs per bag
QR/P1-12P-C(21)	CL0221-0100-2-21	12	51.0	42.0	3.0	12.1°	
QR/P1-16P-C(21)	CL0221-0110-6-21	16	57.6	48.1	3.0	10.6°	
QR/P1-24P-C(21)	CL0221-0112-1-21	24	68.8	59.3	3.0	8.6°	30pcs per bag
QR/P1-32P-C(21)	CL0221-0131-6-21	32	85.5	76.0	4.2	6.0°	

Note : When attaching to the panel, make sure that the mated clearance dimensions on the male and females sides are 1.5mm or less.

Female Housing

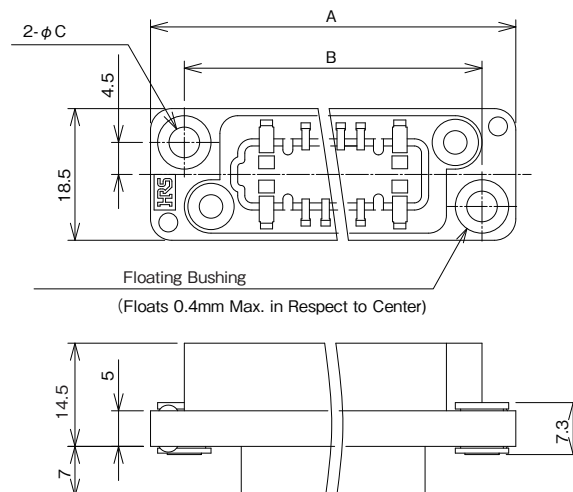

Unit : mm

Part No.	HRS No.	No. of Pos.	A	B	C	Purchase Unit
QR/P1-8S-C(21)	CL0221-0125-3-21	8	46.4	36.9	4.3	50pcs per bag
QR/P1-12S-C(21)	CL0221-0101-5-21	12	51.0	42.0	3.3	
QR/P1-16S-C(21)	CL0221-0111-9-21	16	57.6	48.1	4.3	
QR/P1-24S-C(21)	CL0221-0113-4-21	24	68.8	59.3	4.3	30pcs per bag
QR/P1-32S-C(21)	CL0221-0132-9-21	32	85.5	76.0	4.3	

Note : When attaching to the panel, make sure that the mated clearance dimensions on the male and females sides are 1.5mm or less.

Contact

Male Power Contact

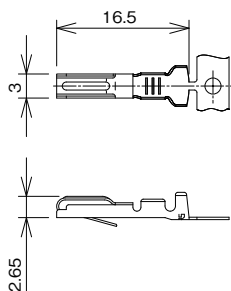

QR/P1-PC1A-211(12)

Part No.	HRS No.	Applicable Cable	Type of Packing	Purchase Unit
QR/P1-PC1B-121(12)	CL0221-0114-7-12	14 to 16 AWG	Loose	100pcs per bag
QR/P1-PC1B-221(12)	CL0221-0118-8-12		Reel	3,000pcs per reel
QR/P1-PC1A-111(12)	CL0221-0102-8-12	18 to 24 AWG	Loose	100pcs per bag
QR/P1-PC1A-211(12)	CL0221-0106-9-12		Reel	5,000pcs per reel

Female Power Contact

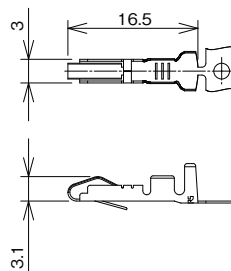

QR/P1-SC1A-211(12)

Part No.	HRS No.	Applicable Cable	Type of Packing	Purchase Unit
QR/P1-SC1B-121(12)	CL0221-0116-2-12	14 to 16 AWG	Loose	100pcs per bag
QR/P1-SC1B-221(12)	CL0221-0120-0-12		Reel	3,000pcs per reel
QR/P1-SC1A-111(12)	CL0221-0104-3-12	18 to 24 AWG	Loose	100pcs per bag
QR/P1-SC1A-211(12)	CL0221-0108-4-12		Reel	5,000pcs per reel

Male Signal Contact

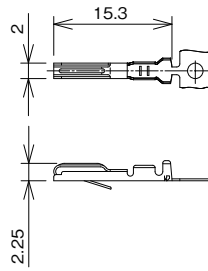

QR/P1-PC2A-211(12)

Part No.	HRS No.	Applicable Cable	Type of Packing	Purchase Unit
QR/P1-PC2B-121(12)	CL0221-0115-0-12	20 to 24 AWG	Loose	100pcs per bag
QR/P1-PC2B-221(12)	CL0221-0119-0-12		Reel	5,000pcs per reel
QR/P1-PC2A-111(12)	CL0221-0103-0-12	24 to 28 AWG	Loose	100pcs per bag
QR/P1-PC2A-211(12)	CL0221-0107-1-12		Reel	5,000pcs per reel

Female Signal Contact

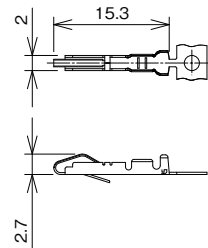

QR/P1-SC2A-211(12)

Part No.	HRS No.	Applicable Cable	Type of Packing	Purchase Unit
QR/P1-SC2B-121(12)	CL0221-0117-5-12	20 to 24 AWG	Loose	100pcs per bag
QR/P1-SC2B-221(12)	CL0221-0121-2-12		Reel	5,000pcs per reel
QR/P1-SC2A-111(12)	CL0221-0105-6-12	24 to 28 AWG	Loose	100pcs per bag
QR/P1-SC2A-211(12)	CL0221-0109-7-12		Reel	5,000pcs per reel

Panel Mounting Dimensions (For Female Housing)

Female Housing (QR/P1-#S-C)

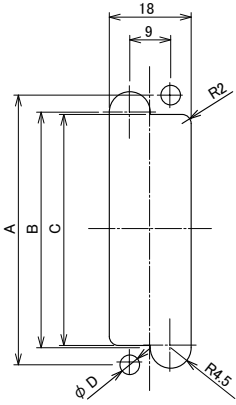

Attachment from Panel Rear Side

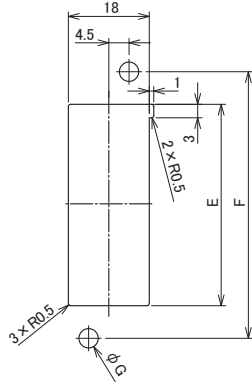

Attachment from Panel Front Side (8 pos.)

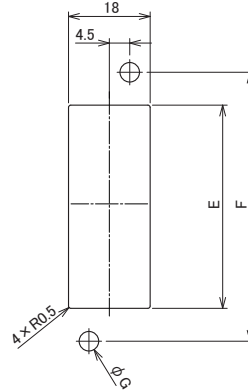

Attachment from Panel Front Side (Except 8 pos.)

Unit : mm

Type		8pos.	12pos.	16pos.	24pos.	32pos.
Rear Mount	A	36.9	42.0	48.1	59.3	76.0
	B	29.4	34.5	40.6	51.8	68.5
	C	28.4	33.5	39.6	50.8	67.5
	D	4.3	3.3	4.3	4.3	4.3
Front Mount	E	22.4	27.5	33.6	44.8	61.0
	F	36.9	42.0	48.1	59.3	76.0
	G	4.3	3.3	4.3	4.3	4.3

Note : The panel mounting dimensions of the male housing are symmetrical to the female housing in respect to the vertical axis.

Power Contact Arrangement

Male Housing (View from the Connection Side)

■ : Contact hole for power supply

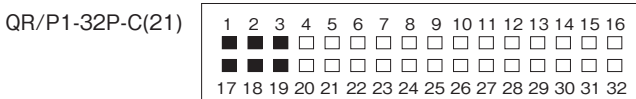
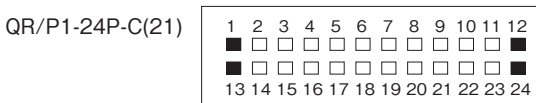
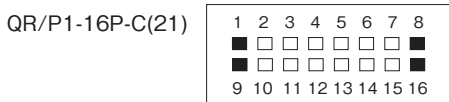
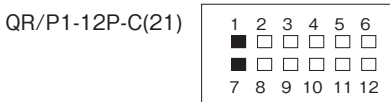
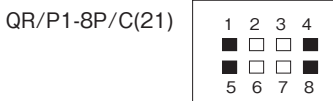

Tools



Manual Crimp Tool

 Automatic Crimp Tool
CM-105C

Type	Part No.	HRS No.	Applicable Contact
Manual Crimp Tool	TC-QR/P1-PC1B	CL0250-0020-0-00	QR/P1-PC1B-121
	TC-QR/P1-PC1A	CL0250-0015-0-00	QR/P1-PC1A-111
	TC-QR/P1-SC1B	CL0250-0022-6-00	QR/P1-SC1B-121
	TC-QR/P1-SC1A	CL0250-0017-6-00	QR/P1-SC1A-111
	TC-QR/P1-PC2B	CL0250-0021-3-00	QR/P1-PC2B-121
	TC-QR/P1-PC2A	CL0250-0016-3-00	QR/P1-PC2A-111
	TC-QR/P1-SC2B	CL0250-0023-9-00	QR/P1-SC2B-121
	TC-QR/P1-SC2A	CL0250-0018-9-00	QR/P1-SC2A-111
Automatic Crimp Tool Applicator	AP105-QR/P1-1B-2	CL0901-2529-6-00	QR/P1-PC1B-221 QR/P1-SC1B-221
	AP105-QR/P1-2B-2	CL0901-2530-5-00	QR/P1-PC2B-221 QR/P1-SC2B-221
	AP105-QR/P1-1A-1	CL0901-2527-0-00	QR/P1-PC1A-211 QR/P1-SC1A-211
	AP105-QR/P1-2A-1	CL0901-2528-3-00	QR/P1-PC2A-211 QR/P1-SC2A-211
Extraction Tool	TC-QR/P1-21	CL0250-0019-1-00	-

While Taking into Consideration

Specifications mentioned in this catalog are reference values.

When considering to order or use this product, please review the Drawing and Product Specifications sheets.

Use an appropriate cable when using the connector in combination with cables.

If considering usage of a non-specified cable, please contact your sales representative.

If assembly process is done by jigs & tools which are not identified by Hirose, assurance will not be given.

If considering usage for below mentioned applications, please contact your sales representative.

In cases where the application will demand a high level of reliability, such as automotive, medical instruments, public infrastructure, aerospace/ defense etc. Hirose must review before assurance of reliability can be given.