

# MODULAR CONNECTORS

CL 222 TM

## Plug for copper foil, stranded wire flat type cable

### Material · Finish

Part name	Material	Finish
Plug case	Polycarbonate	Clear
Terminal	Phosphor Bronze	Gold plated

Applicable Cable	
Conductor diameter	Copper foil or AWG # 26
Insulator diameter	0.9- 1.0

### Electrical Performance

Item	Condition	Specification
Current rating	Per pin	0.5A
Voltage rating	Per pin	125V AC
Insulation Resistance	100V DC	100 M Min.
Withstanding Voltage	1 minute	500V r.m.s AC

### TM3P-44P



(Packing unit: 100 Pcs.)

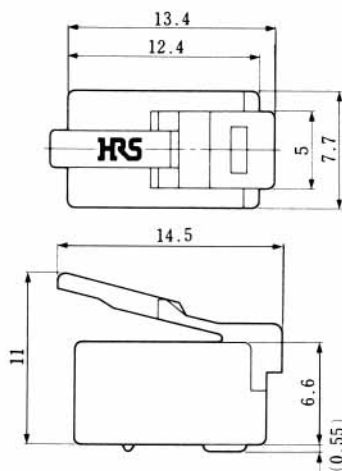

CL No.	Part No.	RoHS
222-0207-2	TM3P-44P	YES

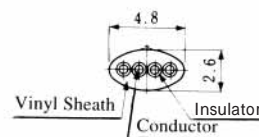

Applicable cable section

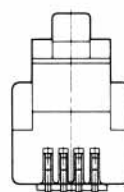

### TM3P-62P, 64P & 66P



(Packing unit: 100 Pcs.)

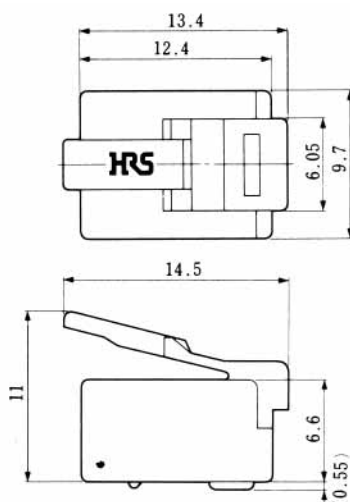

CL No.	Part No.	RoHS
222-0278-0	TM3P-62P	YES
222-0208-5	TM3P-64P	
222-0209-8	TM3P-66P	

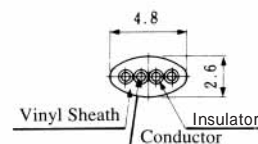

Applicable cable section

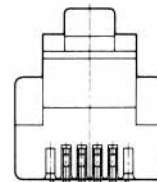

Note: Shown TM3P-64P.

# MODULAR CONNECTORS

CL 222 TM

TM8P-88P

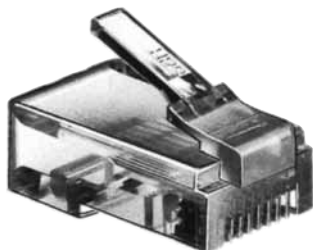

(Packing unit: 100 Pcs.)

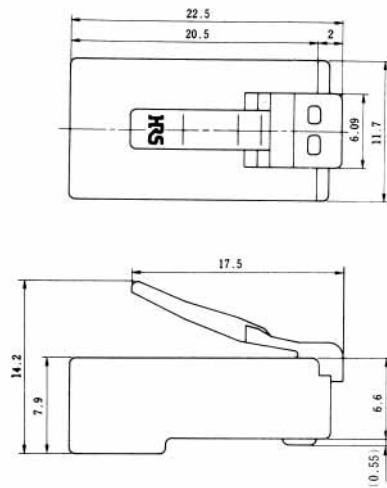

CL No.	Part No.	RoHS
222-1817-9	TM8P-88P	YES

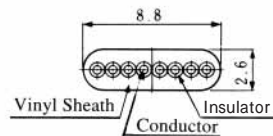

Applicable cable section

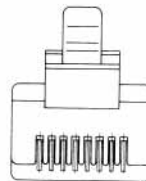

# MODULAR CONNECTORS

CL 222 TM

## Plug for copper foil, stranded wire circular type cable

### Material · Finish

Part name	Material	Finish
Plug case	Polycarbonate	Clear
Terminal	Phosphor Bronze	Gold plated

Applicable Cable	
Conductor diameter	Copper foil or AWG # 26
Insulator diameter	0.9- 1.0

### Electrical Performance

Item	Condition	Specification
Current rating	Per pin	0.5A
Voltage rating	Per pin	125V AC
Insulation Resistance	100V DC	100 M Min.
Withstanding Voltage	1 minute	500V r.m.s AC

### TM4P-44P

CL No.	Part No.	RoHS
222-0279-3	TM4P-44P	YES



(Packing unit: 100 Pcs.)

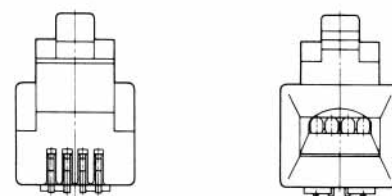
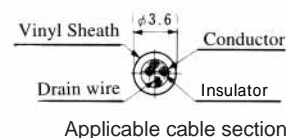
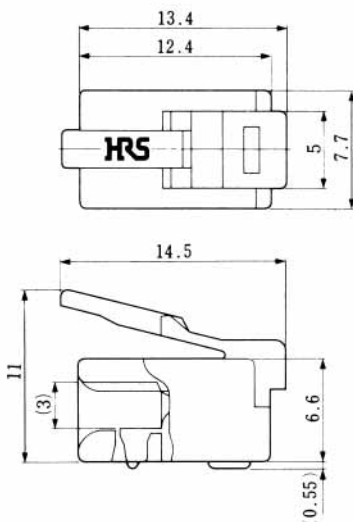

### TM4P-64P & 66P

CL No.	Part No.	RoHS
222-0280-2	TM4P-64P	YES
222-0281-5	TM4P-66P	YES

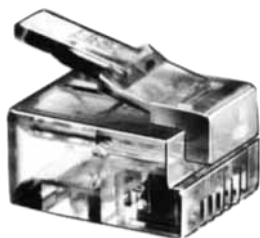

(Packing unit: 100 Pcs.)

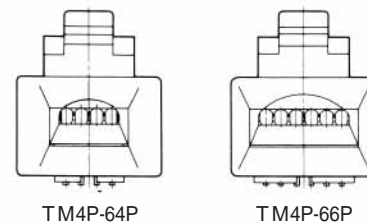
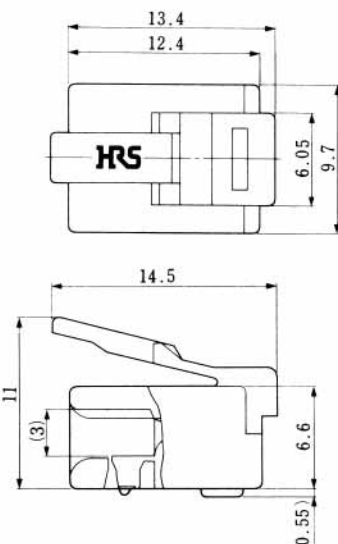

TM4P-64P

TM4P-66P

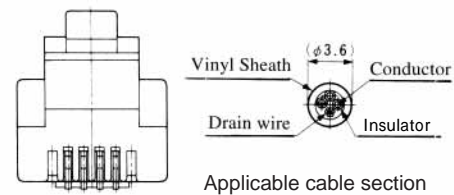

Applicable cable section

Note: Shown TM4P-64P.

# MODULAR CONNECTORS

CL 222 TM

## TM10P-88P

CL No.	Part No.	RoHS
222-1818-1	TM10P-88P	YES

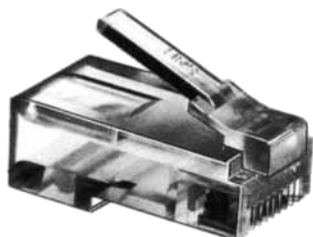

(Packing unit: 100 Pcs.)

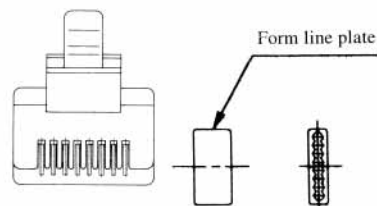
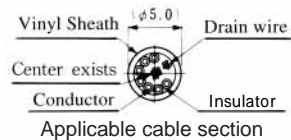
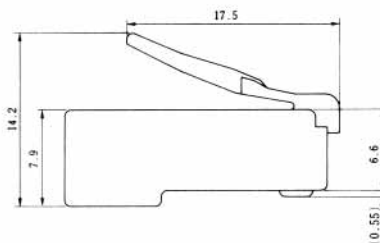
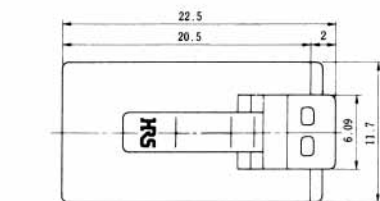

# MODULAR CONNECTORS

CL 222 TM

## Plug Connector Cable Assembly Tool

Hand Tool



CL No.	Part No.	Applicable connector
CL902-2205-0	HT601-TM3/4P-44P	TM3P-44P, TM4P-44P
CL902-2206-3	HT601-TM3/4P-64P	TM3P-64P, TM4P-64P TM3P-62P
CL902-2207-6	HT601-TM3/4P-66P	TM3P-66P, TM4P-66P
250-0228-1	TC-2220-8/10P-88-1	TM8P-88P, TM10P-88P TM10P1-88P

\* This tool is made of metal and offers rigidity and durability. The handle is equipped with a ratchet mechanism that allows the press fit height of the plate contact to be set uniformly, and also permits the prevention of insufficient clamping.

\* The tool can be used for insulation stripping of flat cables and round cables. Note that model HT601-TM3/4P-66P is for use with flat cables only. Also note that model TC-2220-8/10P-88-1 is not equipped with an insulation stripping mechanism.

\* The cable is pulled out by the lever which permits consistent insulation stripping.

Note: Please note that depending on the specifications of the cable, there may be instances in which the insulation cannot be stripped.

When using the tool with products other than Hirose Electric modular plugs, the wiring quality cannot be guaranteed; therefore, please be sure to use Hirose Electric plugs.

Item	Part No.	CL No.	Applicable connector
Press	CM-105	901-0005-4	
Applicator	Applicator 105-TMP-44	901-0195-1	TM3P-44P, TM4P-44P
	Applicator 105-TMP-64	901-0194-9	TM3P-64P, TM4P-64P TM2P-62P
	Applicator 105-TMP-66	901-0193-6	TM3P-66P, TM4P-66P
	AP105-TM10P1-88P	901-2569-0	TM8P-88P, TM10P-88P

# MODULAR CONNECTORS

CL 222 TM

## Plug for Solid Wire Cable

### Material · Finish

Part name	Material	Finish
Plug case	Polycarbonate	Clear
Terminal	Phosphor Bronze	Gold plated

Applicable Cable	
Conductor diameter	0.4 ~ 0.65 *
Insulator diameter	0.96 max.

\* In case of use 0.65, not to be connected fully for 6 pins and 8 pins depend on size of insulator diameter.

### Electrical Performance

Item	Condition	Specification
Current rating	Per pin	0.5A
Voltage rating	Per pin	30V AC
Insulation Resistance	100V DC	100 M Min.
Withstanding Voltage	1 minute	500V r.m.s AC

### TM20P-66P

CL No.	Part No.	RoHS
222-2275-3	TM20P-66P	YES

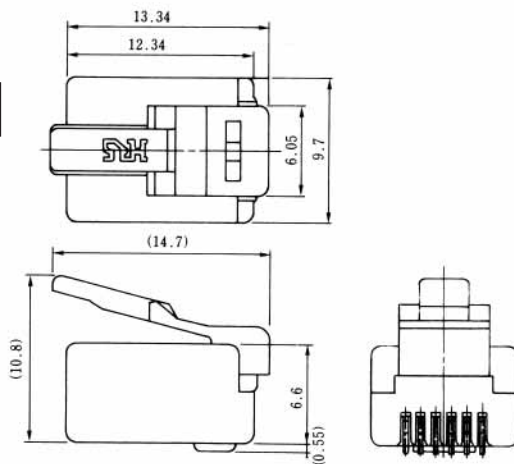

### Mating Condition Figure

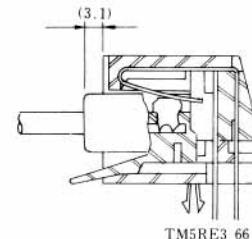

(Packing unit: 100 Pcs.)

### TM20P-88P

CL No.	Part No.	RoHS
222-2217-7	TM20P-88P	YES

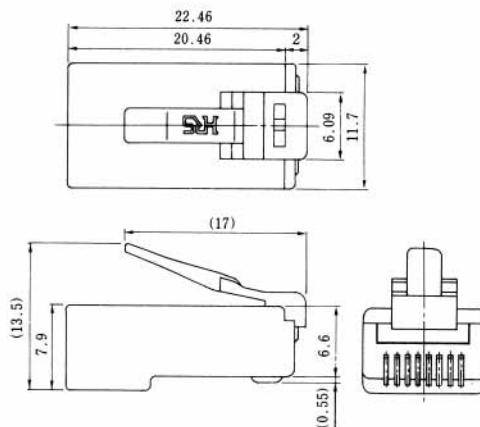

### Mating Condition Figure

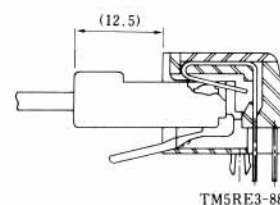

(Packing unit: 100 Pcs.)

## Exclusive Hand Tool for Connection



CL No.	Part No.	Applicable Connector
250-0240-7	TC2-TM20P-66P	TM20P-66P
250-0241-0	TC2-TM20P/30P-88P	TM20P-88P

# MODULAR CONNECTORS

CL 222 TM

## Plug for Thin Wire Cable

### Material • Finish

Part name	Material	Finish
Plug case	Polycarbonate *	6 Pins
		8 Pins
Terminal	Phosphor Bronze	Gold plated

\*UL94V-0

Applicable Cable	
Conductor diameter	AWG # 28( 7/0.127 )
Insulator diameter	0.787 max.

### Electrical Performance

Item	Condition	Specification
Current rating	Per pin	0.5A
Voltage rating	Per pin	125V AC
Insulation Resistance	100V DC	100 M Min.
Withstanding Voltage	1 minute	500V r.m.s AC

### TM30P-66P

CL No.	Part No.	RoHS
222-2684-2	TM30P-66P	YES

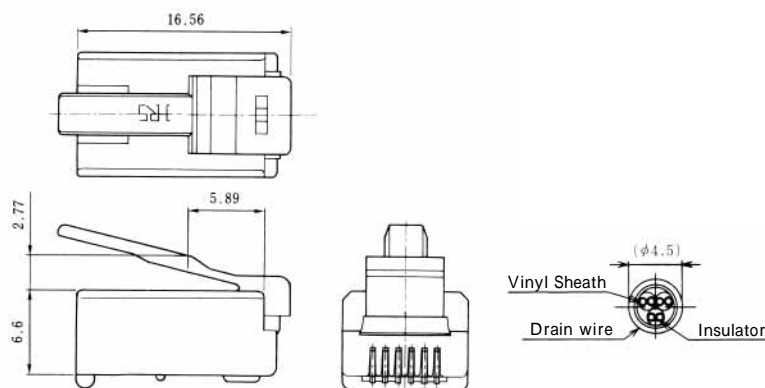

### TM30P-88P

CL No.	Part No.	RoHS
222-2685-5	TM30P-88P	YES

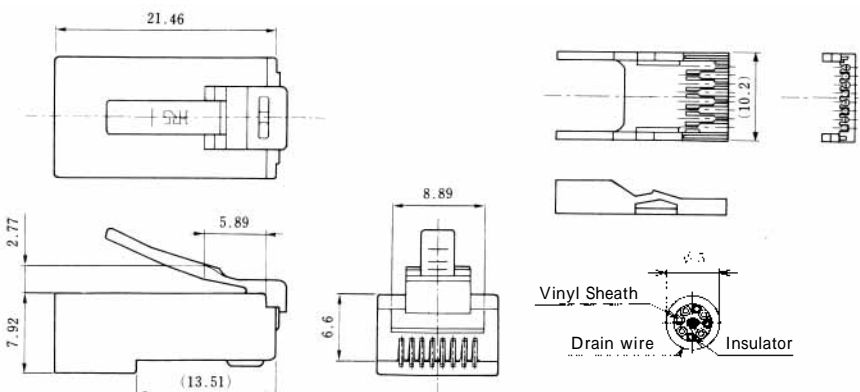

## Exclusive Hand Tool for Connection



CL No.	Part No.	Applicable Connector
250-0145-6	TC1-TM30P-66P	TM30P-66P
250-0241-0	TC2-TM20P/30P-88P	TM30P-88P