

Nov.1.2024 Copyright 2024 HIROSE ELECTRIC CO., LTD. All Rights Reserved.
 In case of consideration for using Automotive equipment / device which demand high reliability, kindly contact our sales window correspondents.

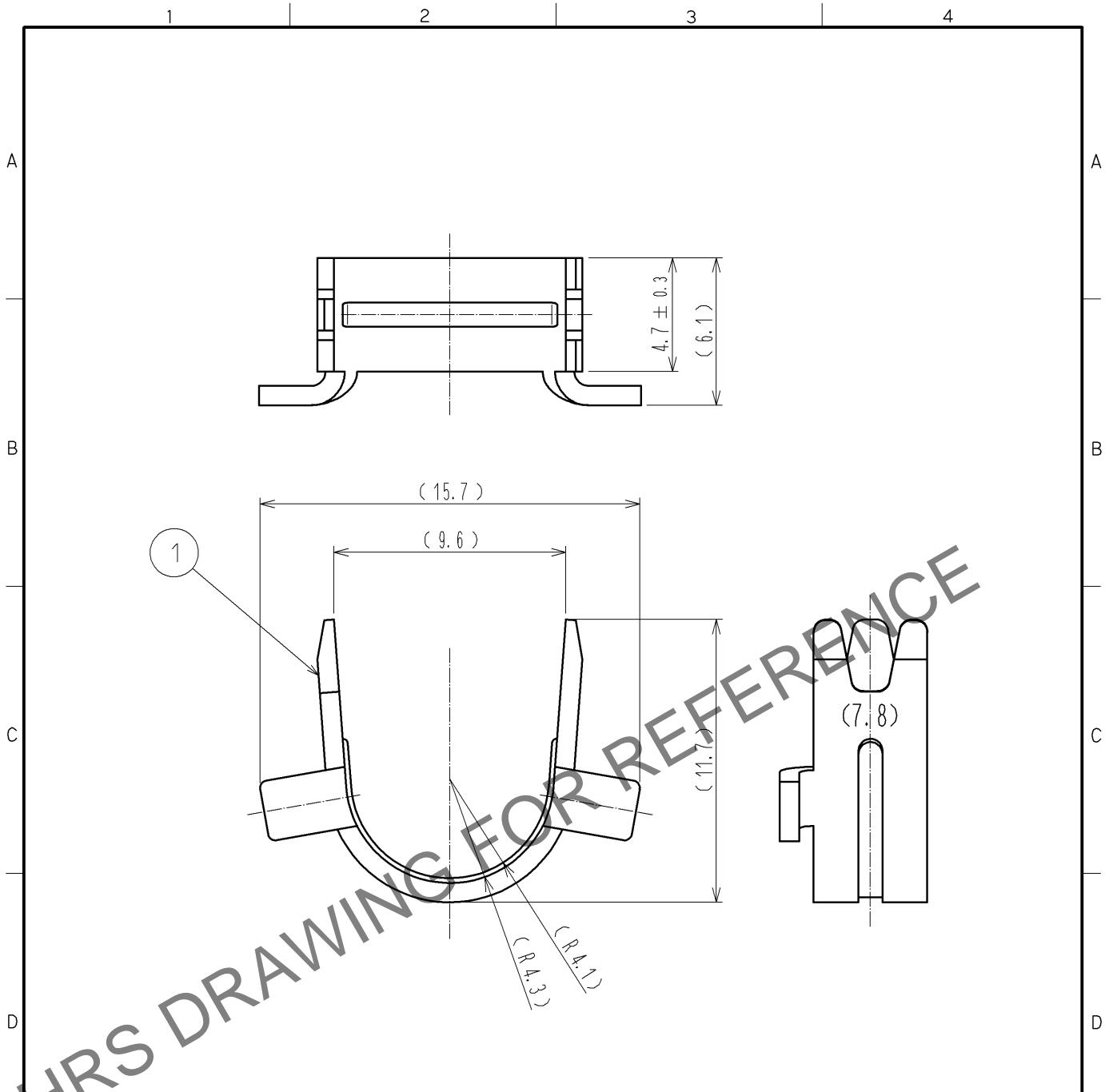

- NOTE 1. THIS PRODUCT IS A CLAMP FOR A COVER CASE 'DH-37-C**B'.
 2. THE APPLICABLE CABLE DIAMETER IS $\phi 7.8$.
 3. THIS PRODUCT IS PACKAGE SALE AND IS 100 PCS 1 PACKAGE.

NO.		MATERIAL		FINISH . REMARKS		1		BRASS		FINISH . REMARKS			
UNITS mm		SCALE 4 : 1		COUNT		DESCRIPTION OF REVISIONS		DESIGNED		CHECKED		DATE	
HIROSE ELECTRIC CO., LTD.		APPROVED :RI. TAKAYASU		11. 09. 13		DRAWING NO.		EDC4-127676-01					
		CHECKED :YH. ENAMI		11. 09. 13		PART NO.		DH-37-CMB(7.8)(01)					
		DESIGNED :YH. MAMADA		11. 09. 09		CODE NO.		CL244-0065-7-01					
		DRAWN :YH. MAMADA		11. 09. 09				1/1					