

Sep.1.2024 Copyright 2024 HIROSE ELECTRIC CO.,LTD. All Rights Reserved.  
 本製品を単載用途などの高い信頼性が求められる機器にご使用の場合は、弊社までお問い合わせ

△数		訂正事項	擔當	檢圖	年月日	△数		訂正事項	擔當	檢圖	年月日
COUNT	DISCRIPTION	OF REVISIONS	B	CHKD	DATE	COUNT	DISCRIPTION	OF REVISIONS	B	CHKD	DATE
△						△					
△						△					
△						△					

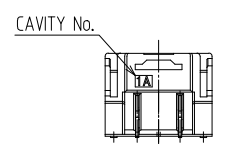

推奨PCBレイアウト (TOP-View)

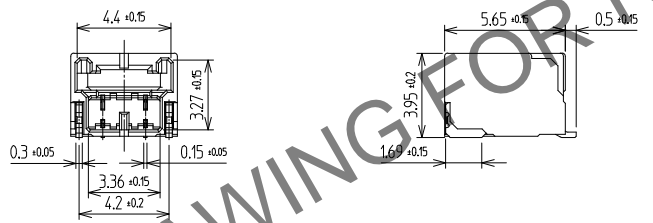
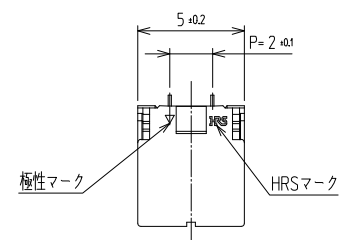
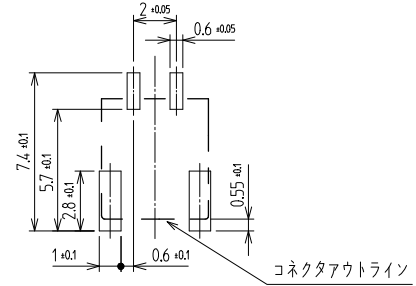

結合状態

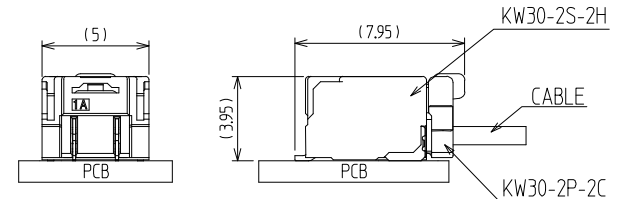

SECTION A-A

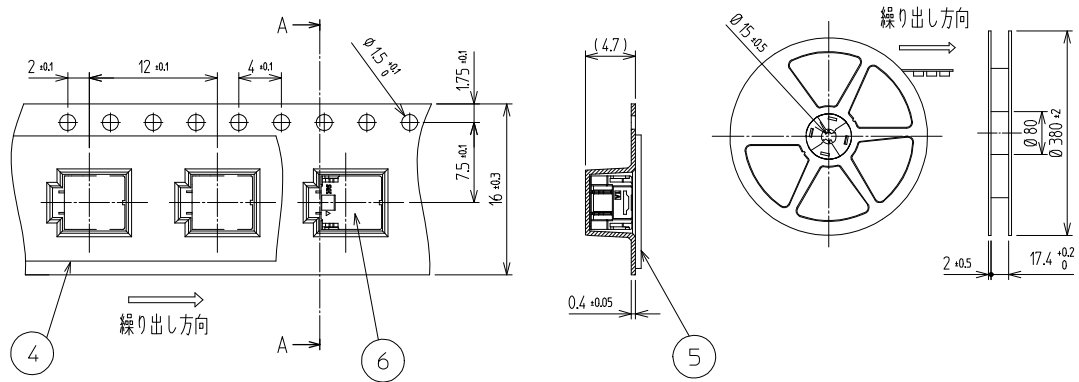

- NOTE
- 平坦度 0.1mm MAX
  - 1リール : 1500個 コネクタ
  - UL (ファイルNo.E132750) 認定品。  
C-UL (ファイルNo.E132750) 認定品。



3	COPPER ALLOY	CONTACT AREA : GOLD 0.2μm MIN. SMT LEAD : GOLD 0.05μm MIN. UNDER PLATING : NICKEL 1μm MIN.	6	CONNECTOR	KW30-2S-2H
2	PHOSPHOR BRONZE	Sn PLATED	5	PET	COVER TAPE
1	LCP	UL94-V0, BLACK	4	PS	EMBOSS CARRIER TAPE
NO.	MATERIAL	FINISH,REMARKS	NO.	MATERIAL	FINISH,REMARKS

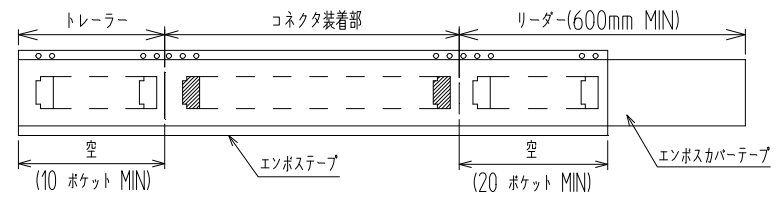

CODE NO. (OLD)		DRAWN	DESIGNED	CHECKED	APPROVED	RELEASED
		CHOI 20.06.05 S.W	CHOI 20.06.05 S.W	LIM 20.06.12 S.M	LIM 20.06.12 S.M	
DRAWING NO. JDC3-633091			PART NO. KW30-2S-2H (800)			
SCALE 2:1			CODE NO. CL 6669-0004-1-800			
UNITS mm			HIROSE KOREA CO.,LTD.			