

Aug.1.2024 Copyright 2024 HIROSE ELECTRIC CO., LTD. All Rights Reserved.
In case of consideration for using Automotive equipment / device which demand high reliability, kindly contact

△數		訂正事項			擔當 檢圖		年月日		△數		訂正事項			擔當 檢圖		年月日	
△	數	DISCRIPTION OF REVISIONS			B	Y	CHKD DATE		△	數	DISCRIPTION OF REVISIONS			B	Y	CHKD DATE	
△									△								
△									△								
△									△								

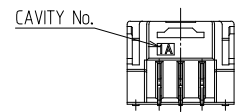

RECOMMENDED PCB LAYOUT (Top-View)

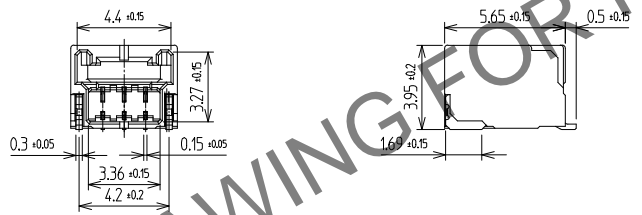
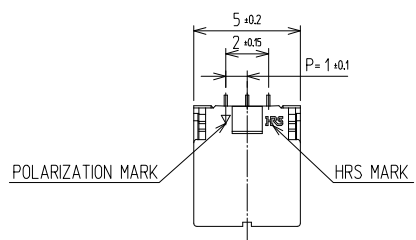
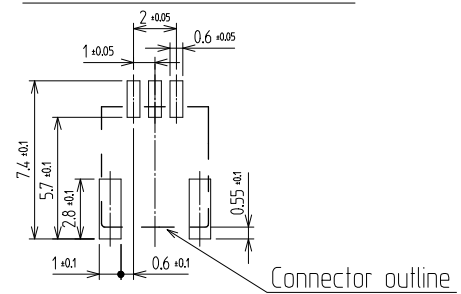

MATING FIGURE

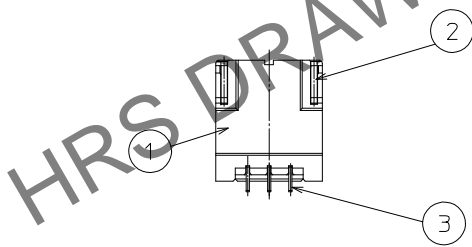
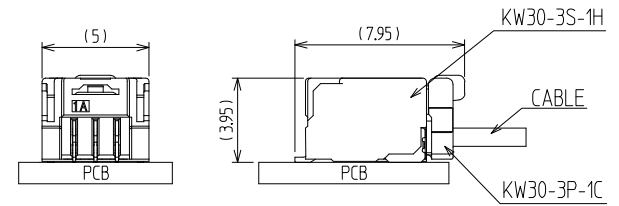

SECTION A-A

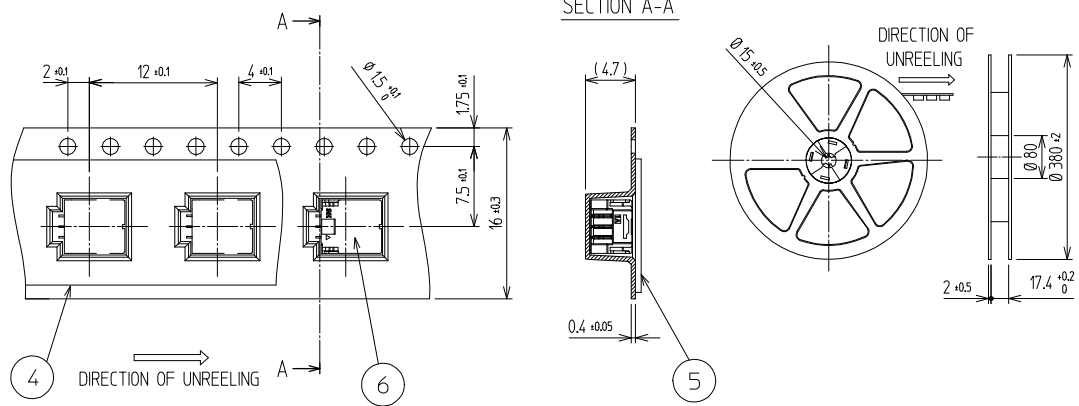

NOTE

1. LEAD CO-PLANARITY SHALL BE 0.1mmMAX
2. 1REEL : 1,500EA CONNECTORS
3. UL(File No. E132750) AUTHORIZATION ARTICLE.
C-UL(File No. E132750) AUTHORIZATION ARTICLE.



3	COPPER ALLOY	CONTACT AREA : GOLD 0.2μm MIN. SMT LEAD : GOLD 0.05μm MIN. UNDER PLATING : NICKEL 1μm MIN.	6	CONNECTOR	KW30-3S-1H
2	PHOSPHOR BRONZE	Sn PLATED	5	PET	COVER TAPE
1	LCP	UL94-V0, BLACK	4	PS	EMBOSS CARRIER TAPE
NO.	MATERIAL	FINISH,REMARKS	NO.	MATERIAL	FINISH,REMARKS

CODE NO. (OLD)	DRAWN	DESIGNED	CHECKED	APPROVED	RELEASED
	CHOI 20.06.05 S.W	CHOI 20.06.05 S.W	LIM 20.06.12 S.M	LIM 20.06.12 S.M	

SCALE	DRAWING NO.	PART NO.
4:1	EDC3-633092	KW30-3S-1H (800)
UNITS	CODE NO.	
mm	CL 6669-0005-4-800	

