

訂正事項			擔當 檢圖			年月日			訂正事項			擔當 檢圖			年月日		
△數	DESCRIPTION	REVISONS	B	CHKD	DATE	△數	DESCRIPTION	REVISONS	B	CHKD	DATE	△數	DESCRIPTION	REVISONS	B	CHKD	DATE
△						△						△					
△						△						△					
△						△						△					

A

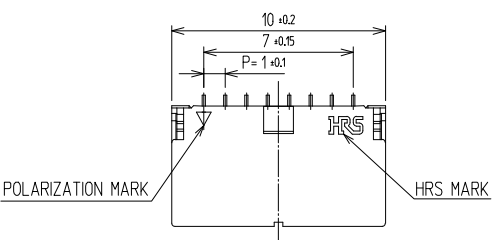

RECOMMENDED PCB LAYOUT (Top-View)

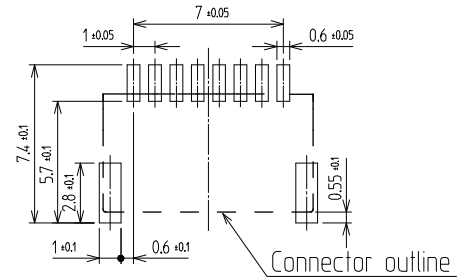

B

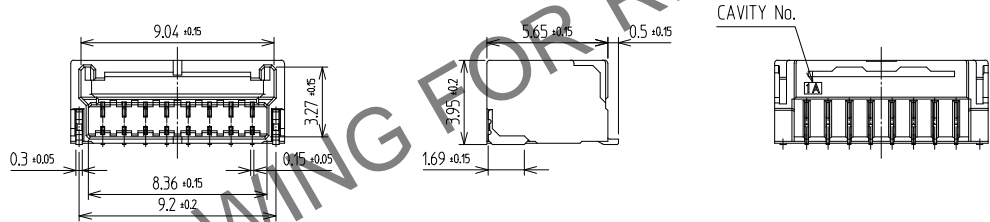

MATING FIGURE

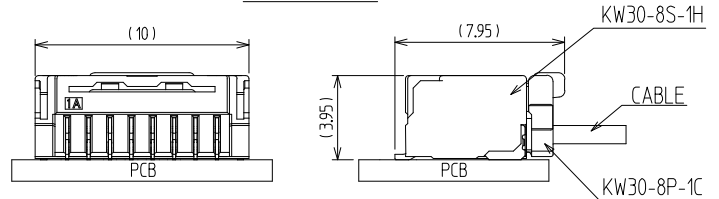

C

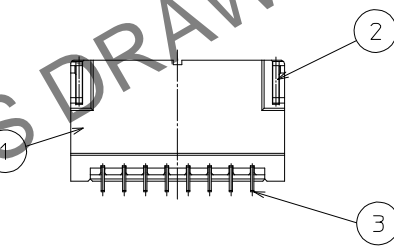

D

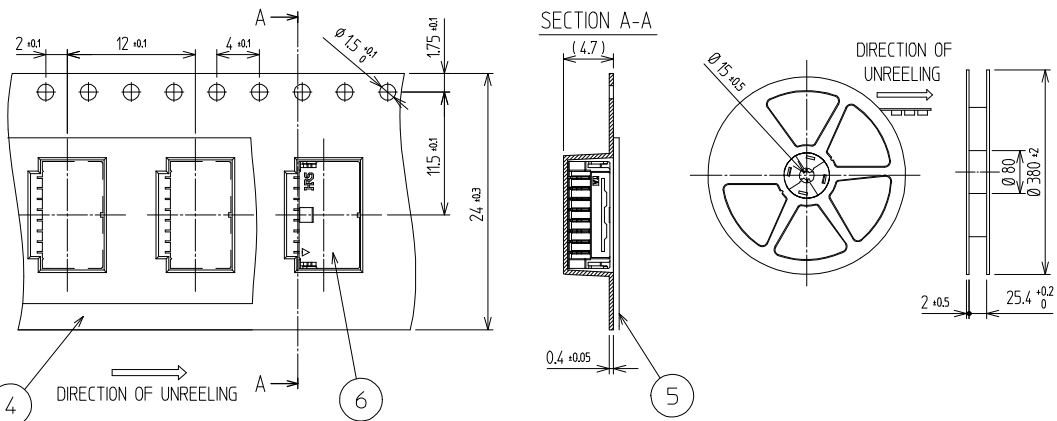

NOTE

- LEAD CO-PLANARITY SHALL BE 0.1mmMAX
- 1REEL : 1,500EA CONNECTORS
- UL(File No. E132750) AUTHORIZATION ARTICLE.
C-UL(File No. E132750) AUTHORIZATION ARTICLE.



3	COPPER ALLOY	CONTACT AREA : GOLD 0.2μm MIN. SMT LEAD : GOLD 0.05μm MIN. UNDER PLATING : NICKEL 1μm MIN.	6	CONNECTOR	KW30-8S-1H
2	PHOSPHOR BRONZE	Sn PLATED	5	PET	COVER TAPE
1	LCP	UL94-V0, BLACK	4	PS	EMBOSS CARRIER TAPE
NO.	MATERIAL	FINISH,REMARKS	NO.	MATERIAL	FINISH,REMARKS

E

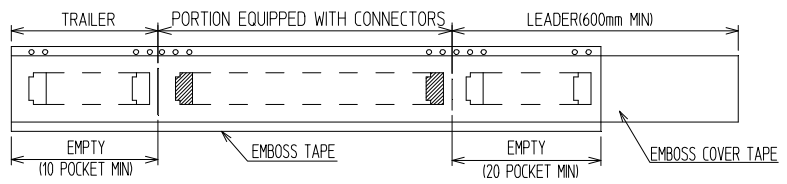

CODE NO. (OLD)	DRAWN	DESIGNED	CHECKED	APPROVED	RELEASED
	CHOI 20.06.05 S.W	CHOI 20.06.05 S.W	LIM 20.06.12 S.M	LIM 20.06.12 S.M	

F

SCALE	4:1	DRAWING NO.	EDC3-633093	PART NO.	KW30-8S-1H (800)
UNITS	mm	HRS HIROSE KOREA CO.,LTD.		CODE NO.	CL 6669-0009-5-800