

Aug.1.2024 Copyright 2024 HIROSE ELECTRIC CO., LTD. All Rights Reserved.
In case of consideration for using Automotive equipment / device which demand high reliability, kindly contact

△數		訂正事項		擔當 檢圖		年月日		△數		訂正事項		擔當 檢圖		年月日	
△	數	DISCUSSION OF REVISIONS		B	Y	DATE		△	數	DISCUSSION OF REVISIONS		B	Y	DATE	
△								△							
△								△							
△								△							

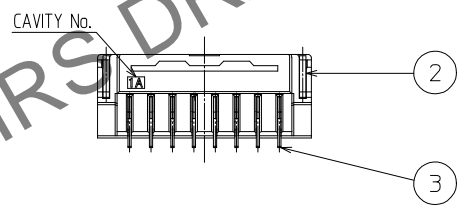

RECOMMENDED PCB LAYOUT (Top-View)

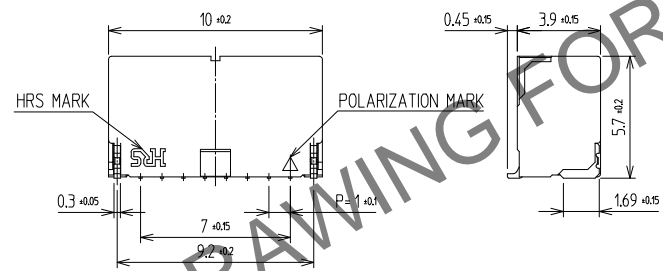
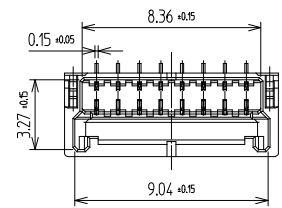
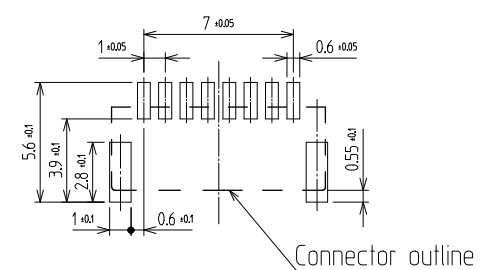

MATING FIGURE

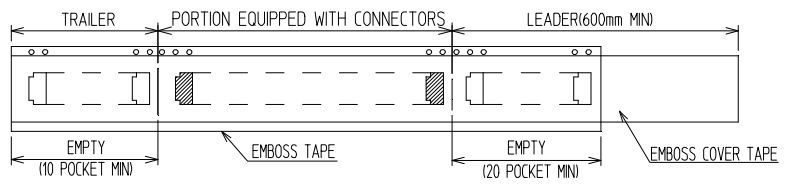
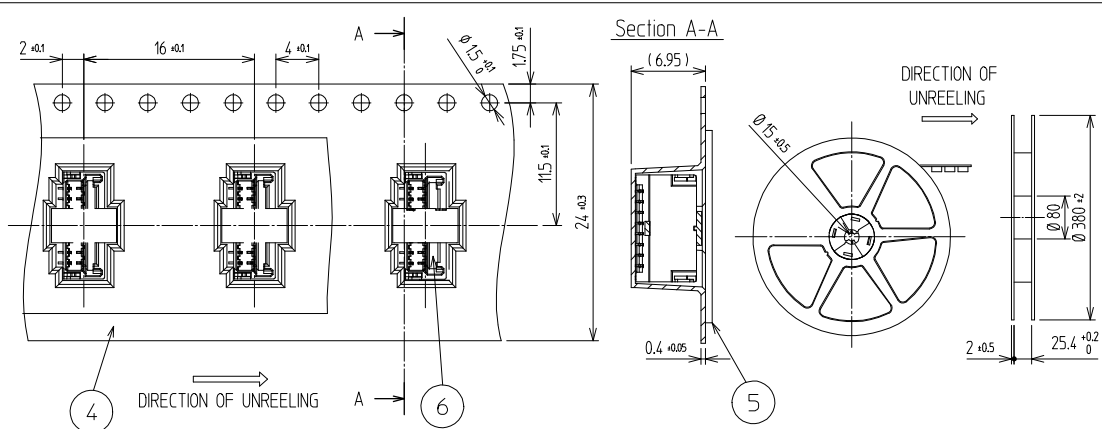
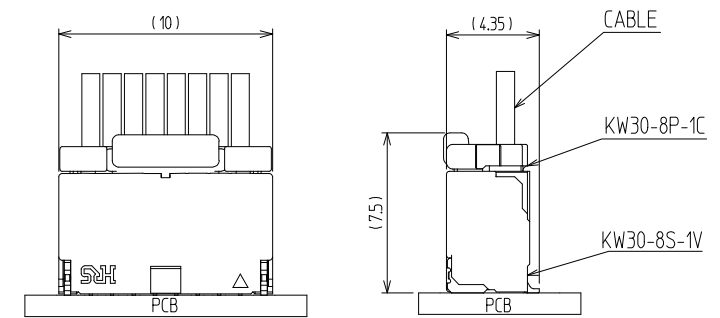

NOTE

1. LEAD CO-PLANARITY SHALL BE 0.1mmMAX
2. 1REEL : 800EA CONNECTORS

3. UL(If No. E132750) AUTHORIZATION ARTICLE.
C-UL(If No. E132750) AUTHORIZATION ARTICLE.



3	COPPER ALLOY	CONTACT AREA : GOLD 0.2μm MIN. SMT LEAD : GOLD 0.05μm MIN. UNDER PLATING : NICKEL 1μm MIN.	6	CONNECTOR	KW30-8S-1V
2	PHOSPHOR BRONZE	Sn PLATED	5	PET	COVER TAPE
1	LCP	UL94-V0, BLACK	4	PS	EMBOSS CARRIER TAPE
NO.	MATERIAL	FINISH,REMARKS	NO.	MATERIAL	FINISH,REMARKS

CODE NO. (OLD)	DRAWN	DESIGNED	CHECKED	APPROVED	RELEASED
	CHOI 20.06.05 S.W	CHOI 20.06.05 S.W	LIM 20.06.12 S.M	LIM 20.06.12 S.M	

SCALE 4:1 UNITS mm	DRAWING NO. EDC3-633099	PART NO. KW30-8S-1V (800)	CODE NO. CL 6669-0023-6-800	1/1
HRS HIROSE KOREA CO.,LTD.				