

ZH05 Series

0.5mm Size, 2mm Pitch, Wire-to-Board Connector with Short-Circuit/Electric Shock Prevention Design

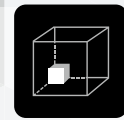

Finger Protect



Space Saving



Contact Reliability

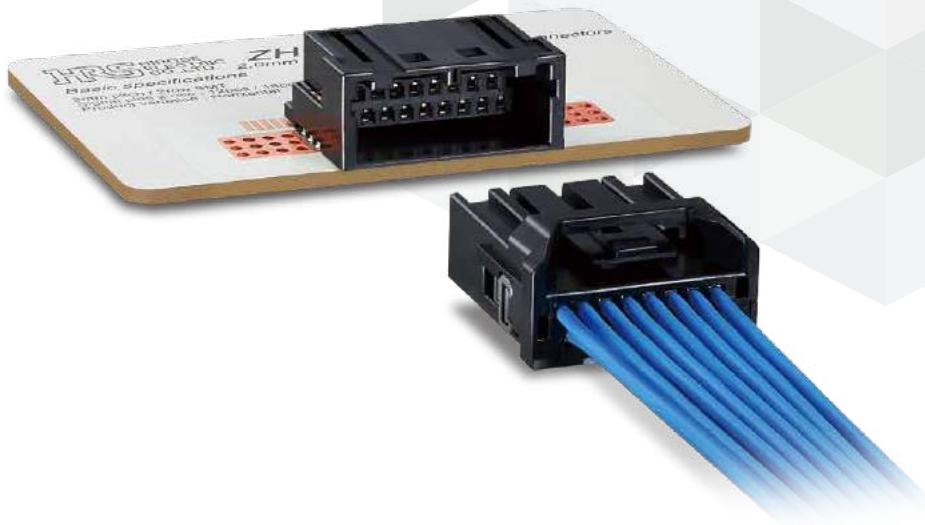

Aug. 1.2024 Copyright 2024 HIROSE ELECTRIC CO., LTD. All Rights Reserved.



Features

1. Compact and narrow width

0.5mm terminal tab size, 2mm pitch.
Contributes to end product size reduction.

2. Short-circuit/electric shock prevention design

Female terminals are used on the board side receptacle, and live parts are completely covered with resin, enhancing assembly safety.

Receptacle/Cross-Section

The female terminals are enclosed in highly insulating resin.

Eliminates two risks

- Board damage due to a short circuit between adjacent terminals
- Operator electric shock from touching the contacts

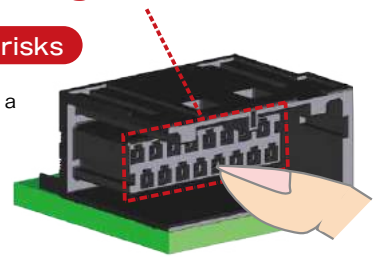

3. High Heat Resistance up to 125°C

- Up to 125°C
- Suitable for automotive and other high-heat applications

Note : Includes the temperature rise due to current flow.

4. High Vibration Resistance

- Female terminal with original 3-point contact design
- Double-layered spring for stability
- Maintains contact under intense vibration, enhancing reliability

① Double-Layered Spring Design

Increases contact force and prevents vibration from outside.

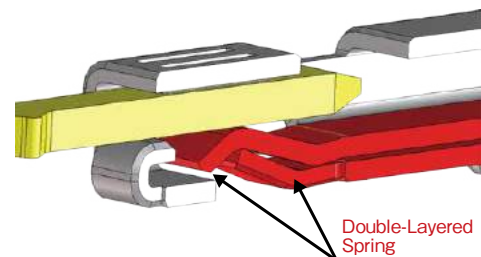

② 3-point Contact Design

Enhanced contact reliability for use under severe vibration.

1 Spring+2 Embossed Contact Points=
3 Contact Points

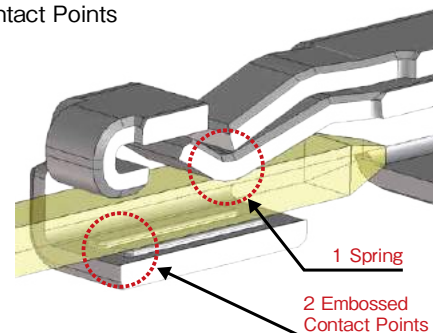

* The terminal is flipped upside down so the embossed contact points are easier to see.

High Vibration Resistance Terminal Design

5. Suitable for Potting

The receptacle minimizes clearance of the press-fit contact area and prevents potting from flowing to the contact point.

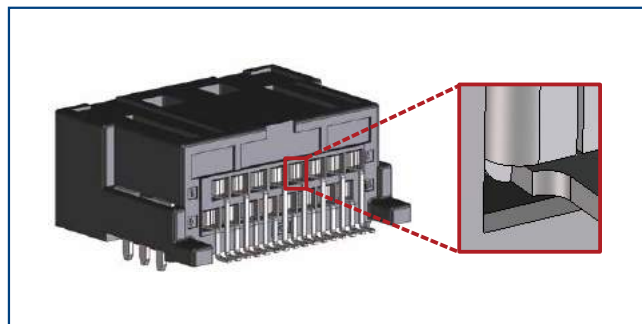

Potting Resin Inflow Prevention Design

6. Two types of mating keys : A and B

Prevents misfitting when using multiple devices.

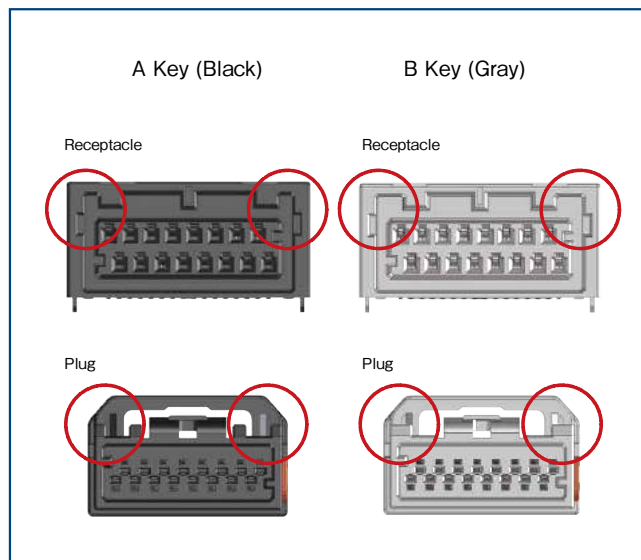

Product Specifications

Rated Current	2A (All pins power supply)	Operating Temperature (Note 1)	-40 to + 125°C
Rated Voltage	60V AC/DC	Storage Temperature Range (Note 2)	-10 to + 60°C
		Storage Humidity Range (Note 2)(Note 3)	Relative humidity 85% Max.

Items	Specifications	Conditions
Contact Resistance	10m Ω Max.	Measured at 1A DC
Insulation Resistance	100M Ω Min.	Measured at 500V DC
Withstanding Voltage	There shall be no dielectric breakdown.	1000V AC for 1 min.
Mating Durability	Contact Resistance : 20m Ω Max.	30 Insertion/Extraction cycles
Vibration Resistance	No electrical discontinuity of 1 μ s or more. Contact Resistance : 20m Ω Max.	Frequency : 20 to 200Hz (Constant Acceleration of 44m/s ²) 1 Cycle 3 min. (round trip), 3 hours in 3 directions
Lock Strength	100N Min.	Lock breaking strength measured when pulling in mating axis direction
Humidity Resistance	Contact Resistance : 20m Ω Max. Insulation Resistance : 100M Ω Min.	Left for 96 hours at a temperature of 60°C and a relative humidity humidity 90 to 95%
Thermal Shock	Contact Resistance : 20m Ω Max.	Temperature : -4°C → Room temperature → +125°C → Room temperature Time : 30 → 5 → 30 → 5 minutes for 1000 cycles
Heat Resistance	Contact Resistance : 20m Ω Max.	Left at 140°C for 120 hours
Cold Resistance	Contact Resistance : 20m Ω Max.	Left at -40°C for 120 hours
Sulfuric Acid Gas Resistance	Contact Resistance : 20m Ω Max.	Left in sulfuric acid gas at room temperature with a concentration of 25ppm and 75% or more RH for 96 hours while unmated

Note 1 : Includes temperature rise caused by current flow.

Note 2 : Storage refers to long-term storage of unused items before they are mounted on the PCB.

Operating temperature and humidity range apply when the product is not powered after PCB mounting and when temporarily stored during transportation.

Note 3 : Use without condensation.

Materials / Finish

Component	Part	Material	Color / Finish	UL Standard
Receptacle	Housing	PA	Black, Gray	UL94V-0
	Female Terminal	Copper Alloy	Tin Plating	-
	Retention Tabs	Brass	Tin Plating	-
Plug	Housing	PA	Black, Gray	UL94V-0
	Retainer	PBT	Dark Gray	UL94V-0
Male Crimp Terminal		Brass	Tin Plating	-

Product Number Structure

Refer to the chart below when determining the product specifications from the product number.
Please select from the product numbers listed in this catalog when placing orders.

● Receptacle/Plug/Retainer

ZH05 - 16 DS - 2 H (A)

① ② ③ ④ ⑤ ⑥

● Male Crimp Terminal

ZH05 - 2224 PCF

① ⑦ ⑧

① Series Name	ZH05	⑤ Product Type	H : Horizontal Mounting Type HU : Socket Housing R : Retainer
② No. of Pos.	16, 20, 24, 28, 32pos.	⑥ Mating Key	(A) : A Key (B) : B Key
③ Connector Type	DS : Receptacle (Female Terminal) DP : Plug	⑦ Applicable Cable	22-24 AWG
④ Pitch	2mm	⑧ Type /Packaging Type	Plug Contact / Reel

Receptacle [SMT+THR (Through Hole Reflow) Type]

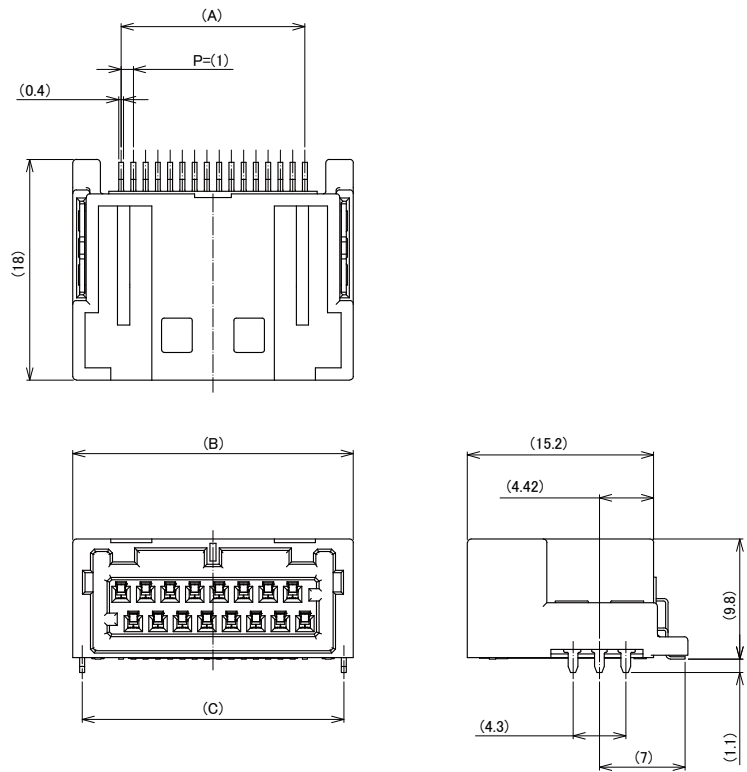

- **Recommended PCB Layout**
 (Board thickness : $t=1.6\text{mm}$, Metal mask thickness : $t=0.1\text{mm}$)

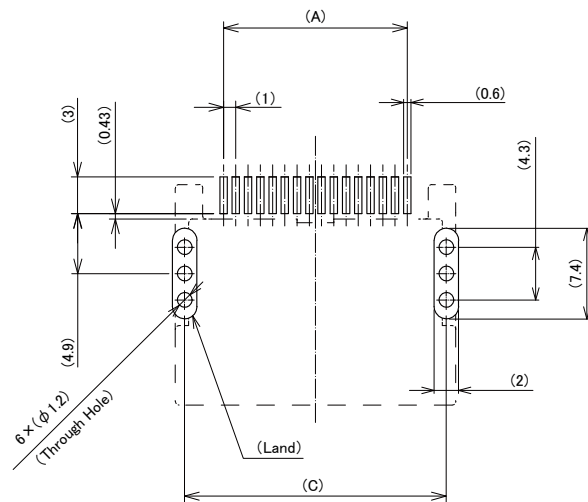

Unit : mm

Part No.	HRS No.	Mating Key	No. of Pos.	A	B	C	Purchase Unit
ZH05-16DS-2H(A)	CL0756-2101-0-80	A Key	16	15.0	22.9	21.36	250pcs per reel
ZH05-16DS-2H(B)	CL0756-2104-0-80	B Key					
ZH05-20DS-2H(A)	CL0756-2102-0-80	A Key	20	19.0	26.9	25.36	
ZH05-20DS-2H(B)	CL0756-2105-0-80	B Key					
ZH05-24DS-2H(A)	CL0756-2108-0-00	A Key	24	23.0	30.9	29.36	
ZH05-24DS-2H(B)	CL0756-2109-0-00	B Key					
ZH05-28DS-2H(A)	Under Planning (Note)	A Key	28	27.0	34.9	33.36	
ZH05-28DS-2H(B)	Under Planning (Note)	B Key					
ZH05-32DS-2H(A)	CL0756-2110-0-00	A Key	32	31.0	38.9	37.36	
ZH05-32DS-2H(B)	CL0756-2111-0-00	B Key					

Note : Products without HRS No. are currently being planned for development. Please contact a Hirose representative regarding questions on pin count variation development.

Plug

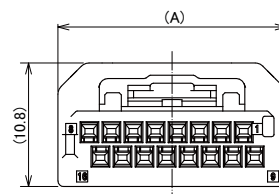
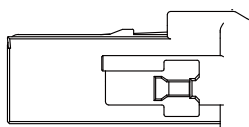
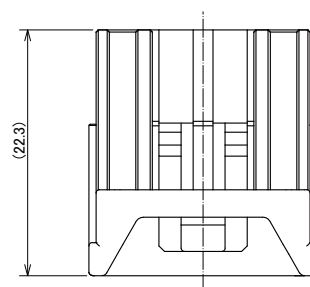

Unit : mm

Part No.	HRS No.	Mating Key	No. of Pos.	A	Purchase Unit
ZH05-16DP-HU(A)	CL0756-2201-0-00	A Key	16	20.7	500pcs per box
ZH05-16DP-HU(B)	CL0756-2207-0-00	B Key			
ZH05-20DP-HU(A)	CL0756-2204-0-00	A Key	20	24.7	
ZH05-20DP-HU(B)	CL0756-2208-0-00	B Key			
ZH05-24DP-HU(A)	CL0756-2212-0-00	A Key	24	28.7	1,500pcs per box
ZH05-24DP-HU(B)	CL0756-2217-0-00	B Key			
ZH05-28DP-HU(A)	Under Planning (Note 1)	A Key	28	32.7	1,250pcs per box
ZH05-28DP-HU(B)	Under Planning (Note 1)	B Key			
ZH05-32DP-HU(A)	CL0756-2218-0-00	A Key	32	36.7	500pcs per box
ZH05-32DP-HU(B)	CL0756-2219-0-00	B Key			

Note 1 : Products without HRS No. are currently being planned for development. Please contact a Hirose representative regarding questions on pin count variation development.

Note 2 : Use with the retainer (ZH05-#DP-R), sold separately.

Male Crimp Terminal

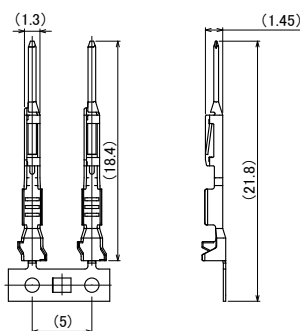

Part No.	HRS No.	Applicable Cable	Packaging Specification	Purchase Unit
ZH05-2224PCF	CL0756-2001-0-00	Applicable Cable : 22-24 AWG (0.2-0.35sq), Coated Outer Diameter ϕ 1.4mm (FLRY)	15,000pcs per reel 5 reels per box (Total of 75,000pcs per box)	75,000pcs per box

Retainer

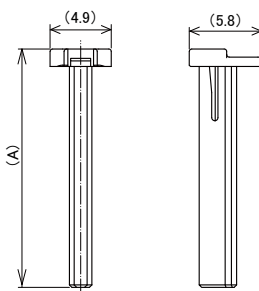

Unit : mm

Part No.	HRS No.	No. of Pos.	A	Purchase Unit
ZH05-16DP-R	CL0756-2215-0-00	16	19.1	10,000pcs per box
ZH05-20DP-R	CL0756-2216-0-00	20	23.1	
ZH05-24DP-R	CL0756-2213-0-00	24	27.1	
ZH05-28DP-R	Under Planning (Note 1)	28	31.1	12,000pcs per box
ZH05-32DP-R	CL0756-2220-0-00	32	35.1	

Note 1 : Products without HRS No. are currently being planned for development. Please contact a Hirose representative regarding questions on pin count variation development.

Note 2 : Attach to the plug (ZH05-#DP-HU(#)), sold separately.

Mated Diagram

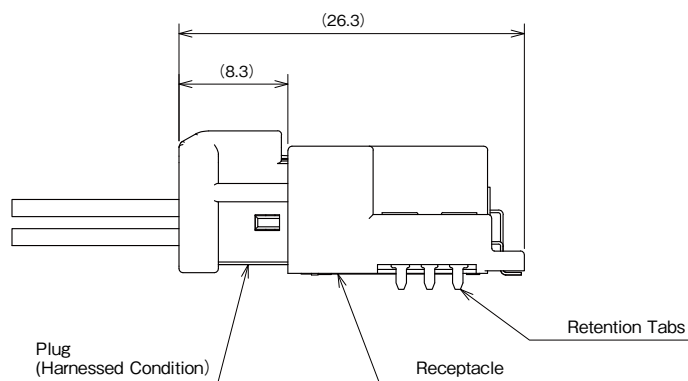

Applicable Tools

Type	Part No.	HRS No.	Compatible Crimp Terminal
Crimping Tool	CM-105C	CL0901-0001-0-00	-
Applicator	AP105-ZH05-2224P	CL0901-5253-0-00	ZH05-2224PCF
Retainer Release Tool	ZH05/R/RE-MD	CL0902-5162-0-00	-
Terminal Extraction Tool	ZH05/RE-MD	CL0902-5161-0-00	-

Note 1 : Conduct crimping based on the "Crimping Standards" and "Crimping Conditions Table".
 Note 2 : Problems with tools not specified by Hirose are outside the scope of warranty.

Usage Precautions

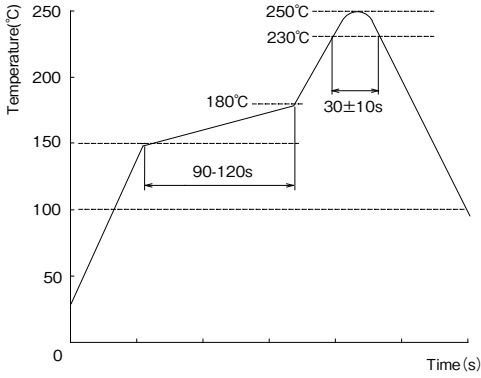
Recommended Temperature Profile	 <p>【Conditions】</p> <ol style="list-style-type: none"> 1. Reflow Heating Method Used : Far infrared, air atmosphere or nitrogen 2. Peak Temperature 250°C Peak 3. Heated part 230°C Min. 20-40 sec. 4. Preheat Temperature 150 to 180°C 90-120 sec. 5. Cycles 2 times Max.
Recommended Manual Soldering Conditions	Soldering iron temperature : 280 to 300°C , Soldering time : within 2 seconds
Precautions	<ol style="list-style-type: none"> 1. Forcing the connector out might cause damage. If challenging to remove, gently press down once and then release the lock. 2. Always disconnect the power before reseating the connector. 3. Avoid touching the terminal area when the power is active, as it's hazardous. 4. For harnessing guidelines, please consult a Hirose representative.

While Taking into Consideration

Specifications mentioned in this catalog are reference values.

When considering to order or use this product, please review the Drawing and Product Specifications sheets.

Use an appropriate cable when using the connector in combination with cables.

If considering usage of a non-specified cable, please contact your sales representative.

If assembly process is done by jigs & tools which are not identified by Hirose, the warranty of the product may be affected.

If considering usage for below mentioned applications, please contact your sales representative.

In cases where the application will demand a high level of reliability, such as automotive, medical instruments, public infrastructure, aerospace/defense etc. Hirose must review before assurance of reliability can be given.