

# 0.5mm/1mm Pitch, 2.55mm Height, 125°C Heat Resistant FPC/FFC Connectors

## FH28K Series

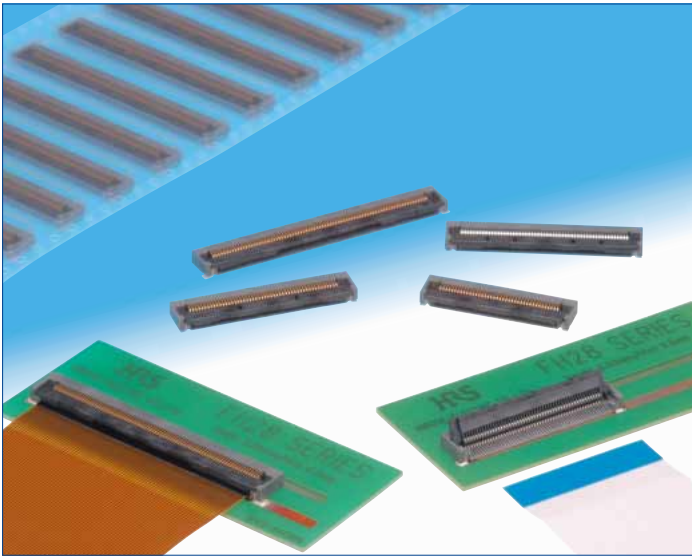

### Robust Lock Design

Retention tabs prevent the actuator from coming off.

Each contact is attached to the actuator and provides support.

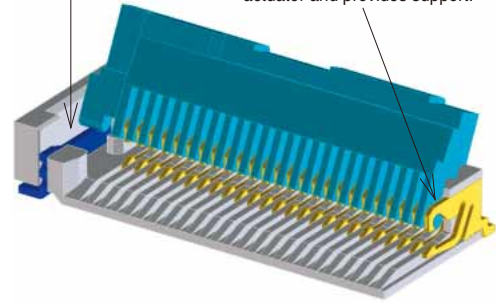

Fig.1

### Features

#### 1. 125°C heat resistance

The 125°C heat resistance design makes FH28K ideal for use in applications requiring high heat resistance such as automotive.

#### 2. Highly reliable connection and robust design

High pin count connectors require a reinforced connector body and high FPC/FFC retention. With its unique FPC/FFC positioning mechanism and robust design that prevents accidental disengagement, the FH28K Series achieves high connection reliability.

#### 3. Flip lock provides superior operability

The flip lock design makes it easier to engage/disengage the actuator and reduces the required force needed to operate. A clear tactile click is delivered upon the successful completion of the mating process. (Fig.1)

#### 4. Enhanced FPC/FFC retention force

Compared to Hirose's 0.5mm pitch connector the FH12 Series, vertical retention force for the FPC/FFC is 2.5 times stronger and horizontal retention force is 2 times stronger.

\*Horizontal retention force value achieved by use of FPC positioning tabs. Use of FPC without positioning tabs results in a horizontal retention value equivalent to FH12 Series.

#### 5. Compatible with 0.3mm FPC/FFC thickness

Compatible with easy to manufacture and easy to insert 0.3mm thick FPC/FFC.

#### 6. No pattern prohibited area on bottom of connector (Overmolding Design)

The bottom of the connector is fully covered with resin, eliminating contact exposure and any restrictions on PCB pattern routing for enhanced design freedom.

#### 7. Pick & Place Mounting

Offered in tape and reel packaging that is compatible with automatic machine mounting. (2,000pcs/reel)

#### 8. Halogen-free

All materials and substances used to produce this product comply with Halogen-free standards.

\*Defined according to IEC61249-2-21. Br : 900ppm maximum, Cl : 900ppm maximum, Br+Cl : 1,500ppm maximum

#### 9. Multiple packing options

The standard packaging is 2,000pcs/reel, but FH28K is also offered in 500pcs/reel. (The outer diameter of the reel will be  $\phi$ 330mm in this case.)

The FPC positioning mechanism and FPC tabs help to guide and hold the FPC prior to engaging the actuator

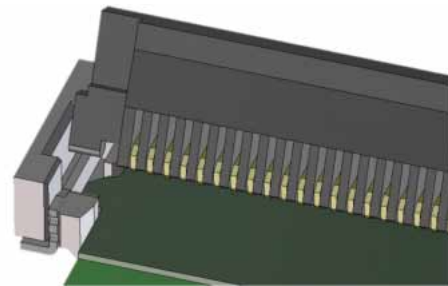

Fig.2

Can also be used with straight sided, non-tabbed FPC/FFC

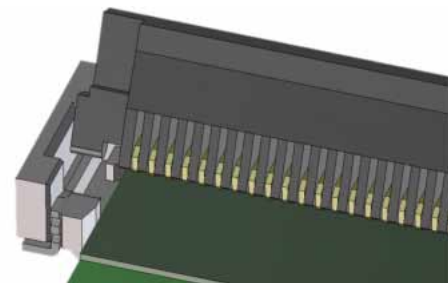

Fig.3

## Product Specifications

Ratings	Rated Current 0.5A	Operating Temperature Range	Storage Temperature Range
	Rated Voltage 50Vrms AC	-40 to +125°C (Note 1) Operating Humidity Range Relative humidity 90% or less (no condensation)	-10 to +50°C (Note 2) Storage Humidity Range Relative humidity 90% or less (no condensation)

Adaptive FPC/FFC Contact Specifications	t=0.3±0.05 Gold plating 125°C Heat Resistant FPC/FFC
---	--

Item	Specification	Conditions
1. Insulation Resistance	Minimum of 500MΩ	Measured with 100V DC
2. Withstanding Voltage	No flashover or breakdown	150Vrms AC is applied for 1 min.
3. Contact Resistance	Maximum of 50mΩ *Includes FPC/FFC conductor resistance	Measured at 1mA (DC or 1,000Hz)
4. Mating Durability	Contact Resistance : Maximum of 50mΩ No damaged, cracked or looseness of parts	20 mating cycles
5. Vibration Resistance	No electrical discontinuity of 1μs or greater Contact Resistance : Maximum of 50mΩ No damages, cracks and looseness of parts	Frequency : 10 to 55Hz Single amplitude of 0.75mm for 10 cycles in 3 axial directions
6. Shock Resistance	No electric discontinuity of 1μs or greater Contact Resistance : Maximum of 50mΩ No damaged, cracked or looseness of parts	Acceleration of 981m/s <sup>2</sup> , 6ms duration, sine half-wave waveform 3 cycles in each of the 3 axis
7. Humidity Resistance of Steady State	Contact Resistance : Maximum of 50mΩ Insulation Resistance : Minimum of 50MΩ No damaged, cracked or looseness of parts	96 hours at temperature : 60°C and humidity : 90 to 95%
8. Temperature Cycles	Contact Resistance : Maximum of 50mΩ Insulation Resistance : Minimum of 50MΩ No damaged, cracked or looseness of parts	Temperature : -40→+15 to +35→+125→+15 to +35°C Time : 30→2 to 3→30→2 to 3 minutes 1000 cycles
9. Solder Heat Resistance	Should not have external deformity or loose parts	Reflow : according to the Recommended Temperature Profile Hand solder : 350±10°C for 5 seconds

Note 1 : Includes temperature rise caused by current flow.

Note 2 : The term "storage" here refers to products stored for a long period prior to board mounting and use. The operating temperature and humidity range covers the non-energized condition of connectors after board mounting and the temporary storage.

## Materials / Finish

Component	Materials	Color/Finish	Remarks
Insulator	LCP	Gray	UL94V-0
	LCP	Black	
Contact	Copper Alloy	Partially Gold Plated	_____
Metal fitting	Brass	Pure Tin Plating	_____

## Product Number Structure

Refer to the chart below when determining the product specifications from the product number.

Please select from the product numbers listed in this catalog when placing orders.

**FH 28K H - 50 (25) S B - 0.5 SH (98)**

① ② ③ ④ ⑤ ⑥ ⑦ ⑧ ⑨ ⑩

① Series Name : FH	⑥ Contact arrangement : Single (single row)
② Series No. : 28K	⑦ Eccentric direction : Blank...Standard type (without eccentricity) B...Eccentric type (contacts on the opposite side of polarity mark)
③ None : Standard type H : Space-saving type	⑧ Contact Pitch : 0.5mm, 1mm
④ Standard type : The number of positions Eccentric type : Number of positions in 0.5mm housing	⑨ Mounting direction , SH...SMT horizontal mounting type
⑤ Standard type : Blank Eccentric type : Number of positions	⑩ Specification : Blank ...Standard, 2,000 pcs/reel (98)...500 pcs/reel

## Connector Dimensions

### 0.5mm Pitch Product

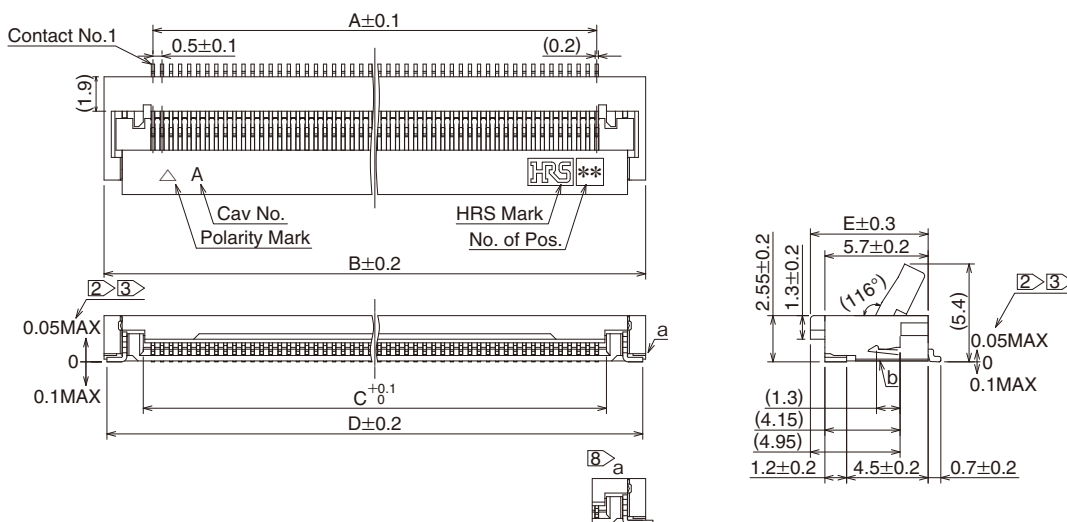

- Notes
- The dimension in parentheses are for reference.
  - Lead co-planarity including retention tabs shall be 0.1 max.
  - Indicates dimensions from surface b.
  - Delivered in tape and reel packages. See the packaging specifications for details.
  - Note that preventive hole for sink mark or slits could be added for improvement.
  - Black spots may appear on the molded plastic however this does not represent a quality issue.
  - This product satisfies halogen free requirements defined as 900ppm maximum chlorine, 900ppm maximum bromine, and 1500ppm maximum total of chlorine and bromine.
  - FH28KH has retention tabs extending outward from the connector body as shown in the diagram.

## Connector Dimensions Table

Unit : mm

Part No.	HRS No.	No. of Pos.	A	B	C	D	E
FH28K-10S-0.5SH(**)	586-1876-0 **	10	4.5	9.9	5.57	9.58	6.5
FH28K-15S-0.5SH(**)	586-1883-0 **	15	7	12.4	8.07	12.08	6.5
FH28K-20S-0.5SH(**)	586-1879-0 **	20	9.5	14.9	10.57	14.58	6.5
FH28K-28S-0.5SH(**)	586-1880-0 **	28	13.5	18.9	14.57	18.58	6.5
FH28K-30S-0.5SH(**)	586-1877-0 **	30	14.5	19.9	15.57	19.58	6.5
FH28K-40S-0.5SH(**)	586-1878-0 **	40	19.5	24.9	20.57	24.58	6.5
FH28K-45S-0.5SH(**)	586-1884-0 **	45	22	27.4	23.07	27.08	6.5
FH28K-50S-0.5SH(**)	586-1875-0 **	50	24.5	29.9	25.57	29.58	6.5
FH28K-55S-0.5SH(**)	586-1881-0 **	55	27	32.4	28.07	32.08	6.5
FH28K-60S-0.5SH(**)	586-1872-0 **	60	29.5	34.9	30.57	34.58	6.5
FH28K-64S-0.5SH(**)	586-1882-0 **	64	31.5	36.9	32.57	36.58	6.5
FH28K-68S-0.5SH(**)	586-1873-0 **	68	33.5	38.9	34.57	38.58	6.5
FH28K-74S-0.5SH(**)	586-1885-0 **	74	36.5	41.9	37.57	41.58	6.5
FH28KH-80S-0.5SH(**)	586-1874-0 **	80	39.5	44.9	40.57	45.7	6

## Connector Dimensions

### 1mm Pitch Product

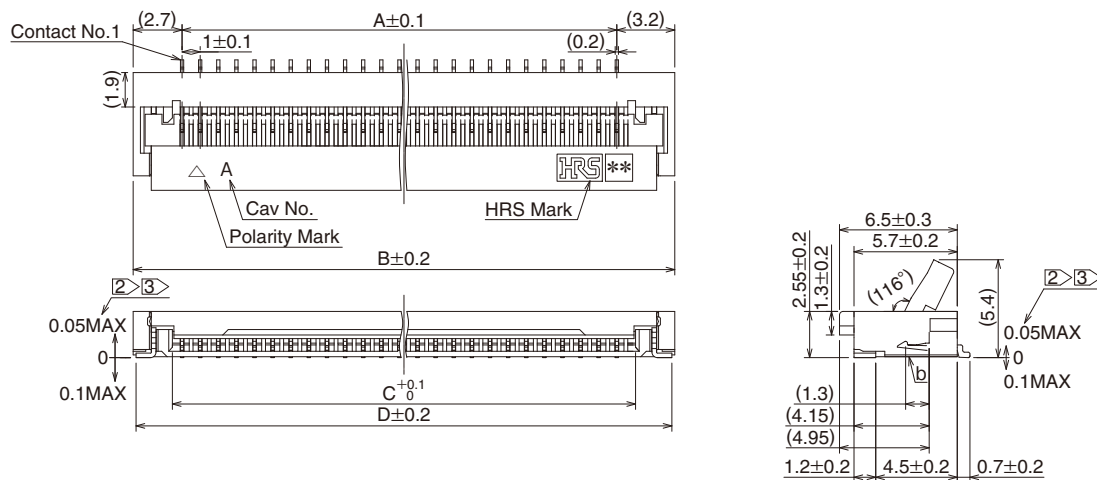

Notes 1 The dimension in parentheses are for reference.

2 Lead co-planarity including retention tabs shall be 0.1 max.

3 Indicates dimensions from surface b.

4 Delivered in tape and reel packages. See the packaging specifications for details.

5 Note that preventive hole for sink mark or slits could be added for improvement.

6 Black spots may appear on the molded plastic however this does not represent a quality issue.

7 This product satisfies halogen free requirements defined as 900ppm maximum chlorine, 900ppm maximum bromine, and 1500ppm maximum total of chlorine and bromine.

## Connector Dimensions Table

Unit : mm

Part No.	HRS No.	No. of Pos.	A	B	C	D
FH28K-20(10)SB-1SH(**)	—	10	9	14.9	10.57	14.58
FH28K-30(15)SB-1SH(**)	—	15	14	19.9	15.57	19.58
FH28K-40(20)SB-1SH(**)	—	20	19	24.9	20.57	24.58
FH28K-50(25)SB-1SH(**)	—	25	24	29.9	25.57	29.58
FH28K-60(30)SB-1SH(**)	—	30	29	34.9	30.57	34.58
FH28K-64(32)SB-1SH(**)	—	32	31	36.9	32.57	36.58
FH28K-68(34)SB-1SH(**)	—	34	33	38.9	34.57	38.58

Note : Contact positions without HRS No. are currently planned for development.

Please contact Hirose for detailed information about product variation.

**Recommended PCB Layout for 0.5mm Pitch Products**

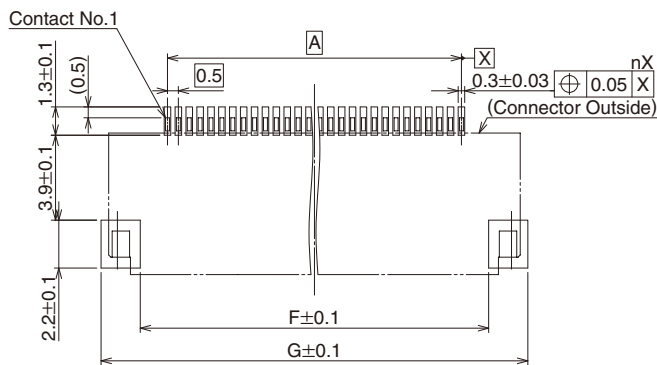

Standard Type (FH28K)

**Recommended Metal Mask Dimensions for 0.5mm Pitch Products**

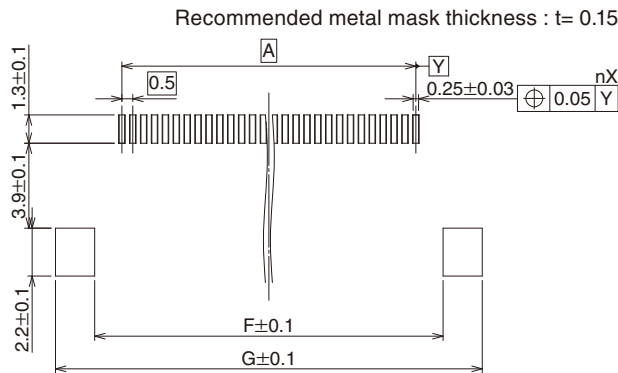

Standard Type (FH28K)

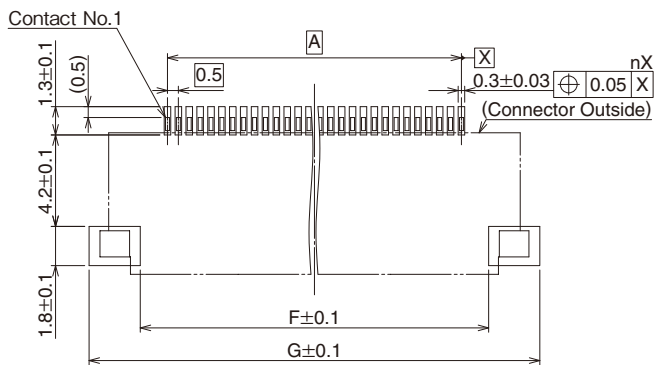

Space-saving Type (FH28KH)

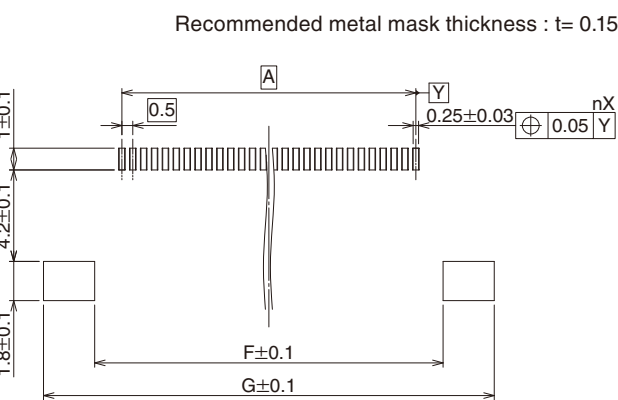

Space-saving Type (FH28KH)

Note : 'n' indicates the number of positions.

**Recommended PCB Layout and Metal Mask Dimensions**

Unit : mm

Part No.	HRS No.	No. of Pos.	A	F	G
FH28K-10S-0.5SH(**)	586-1876-0 **	10	4.5	7	10.6
FH28K-15S-0.5SH(**)	586-1883-0 **	15	7	9.5	13.1
FH28K-20S-0.5SH(**)	586-1879-0 **	20	9.5	12	15.6
FH28K-28S-0.5SH(**)	586-1880-0 **	28	13.5	16	19.6
FH28K-30S-0.5SH(**)	586-1877-0 **	30	14.5	17	20.6
FH28K-40S-0.5SH(**)	586-1878-0 **	40	19.5	22	25.6
FH28K-45S-0.5SH(**)	586-1884-0 **	45	22	24.5	28.1
FH28K-50S-0.5SH(**)	586-1875-0 **	50	24.5	27	30.6
FH28K-55S-0.5SH(**)	586-1881-0 **	55	27	29.5	33.1
FH28K-60S-0.5SH(**)	586-1872-0 **	60	29.5	32	35.6
FH28K-64S-0.5SH(**)	586-1882-0 **	64	31.5	34	37.6
FH28K-68S-0.5SH(**)	586-1873-0 **	68	33.5	36	39.6
FH28K-74S-0.5SH(**)	586-1885-0 **	74	36.5	39	42.6
FH28KH-80S-0.5SH(**)	586-1874-0 **	80	39.5	42	45.6

### Recommended PCB Layout for 1mm Pitch Products

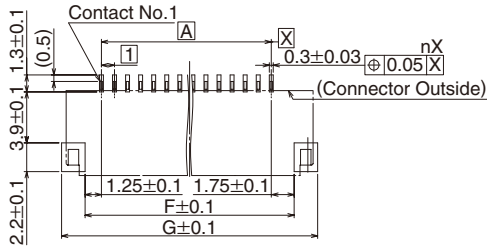

### Recommended Metal Mask Dimensions for 1mm Pitch Products

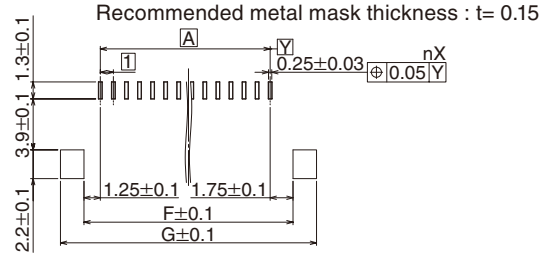

Note : 'n' indicates the number of positions.

### Recommended PCB Layout and Metal Mask Dimensions

Unit : mm

Part No.	HRS No.	No. of Pos.	A	F	G
FH28K-20(10)SB-1SH(**)	---	10	9	12	15.6
FH28K-30(15)SB-1SH(**)	---	15	14	17	20.6
FH28K-40(20)SB-1SH(**)	---	20	19	22	25.6
FH28K-50(25)SB-1SH(**)	---	25	24	27	30.6
FH28K-60(30)SB-1SH(**)	---	30	29	32	35.6
FH28K-64(32)SB-1SH(**)	---	32	31	34	37.6
FH28K-68(34)SB-1SH(**)	---	34	33	36	39.6

Note : Contact positions without HRS No. are currently planned for development.  
Please contact Hirose for detailed information about product variation.

### Recommended FPC/FFC Dimensions for 0.5mm Pitch Products

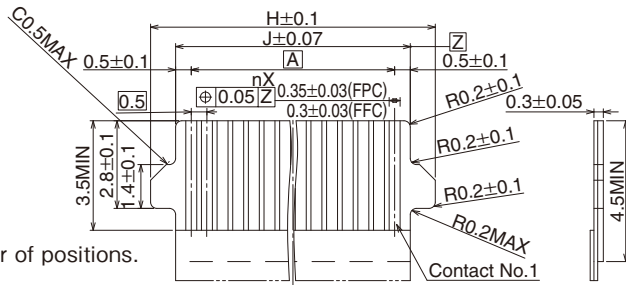

Note : 'n' indicates the number of positions.

### Recommended FPC/FFC Dimensions

Unit : mm

Part No.	HRS No.	No. of Pos.	A	H	J
FH28K-10S-0.5SH(**)	586-1876-0 **	10	4.5	7.1	5.5
FH28K-15S-0.5SH(**)	586-1883-0 **	15	7	9.6	8
FH28K-20S-0.5SH(**)	586-1879-0 **	20	9.5	12.1	10.5
FH28K-28S-0.5SH(**)	586-1880-0 **	28	13.5	16.1	14.5
FH28K-30S-0.5SH(**)	586-1877-0 **	30	14.5	17.1	15.5
FH28K-40S-0.5SH(**)	586-1878-0 **	40	19.5	22.1	20.5
FH28K-45S-0.5SH(**)	586-1884-0 **	45	22	24.6	23
FH28K-50S-0.5SH(**)	586-1875-0 **	50	24.5	27.1	25.5
FH28K-55S-0.5SH(**)	586-1881-0 **	55	27	29.6	28
FH28K-60S-0.5SH(**)	586-1872-0 **	60	29.5	32.1	30.5
FH28K-64S-0.5SH(**)	586-1882-0 **	64	31.5	34.1	32.5
FH28K-68S-0.5SH(**)	586-1873-0 **	68	33.5	36.1	34.5
FH28K-74S-0.5SH(**)	586-1885-0 **	74	36.5	39.1	37.5
FH28KH-80S-0.5SH(**)	586-1874-0 **	80	39.5	42.1	40.5

### Recommended FPC/FFC Dimensions for 1mm Pitch Products

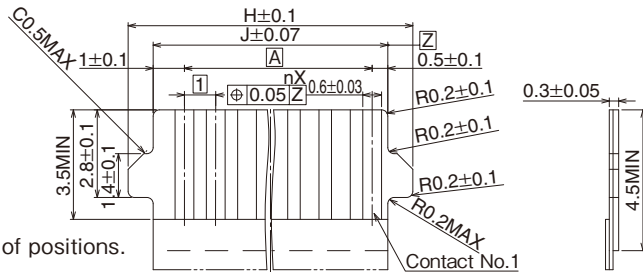

Note : 'n' indicates the number of positions.

### Recommended FPC/FFC Dimensions

Unit : mm

Part No.	HRS No.	No. of Pos.	A	H	J
FH28K-20(10)SB-1SH(**)	---	10	9	12.1	10.5
FH28K-30(15)SB-1SH(**)	---	15	14	17.1	15.5
FH28K-40(20)SB-1SH(**)	---	20	19	22.1	20.5
FH28K-50(25)SB-1SH(**)	---	25	24	27.1	25.5
FH28K-60(30)SB-1SH(**)	---	30	29	32.1	30.5
FH28K-64(32)SB-1SH(**)	---	32	31	34.1	32.5
FH28K-68(34)SB-1SH(**)	---	34	33	36.1	34.5

Note : Contact positions without HRS No. are currently planned for development.  
Please contact Hirose for detailed information about product variation.

## ◆ FH28K Series FPC/FFC Material Configuration (Recommended Specifications)

### 1. Single-Sided FPC

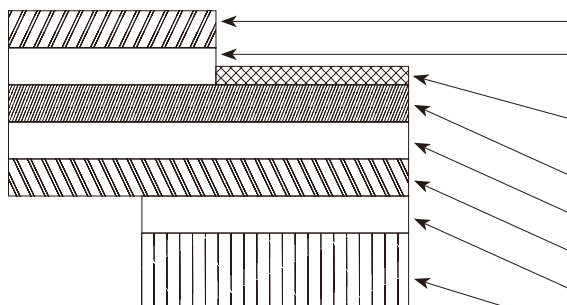

### FPC : Flexible Printed Circuit

Layer	Materials	Thickness (μm)
Cover Lay Film	Polymide 1mil	(25)
Cover Adhesive		(25)
Surface Treatment	Nickel Under Plating 1~5μm+ gold plating 0.2μm	3
Copper Foil	Cu 1oz	35
Base Adhesive	Heat Stiffener Adhesive	25
Base Film	Polymide 1mil	25
Stiffener Adhesive	Heat Stiffener Adhesive	30
Reinforcing Film	Polymide 7mil	175
Total		293

### 2. Double-Sided FPC

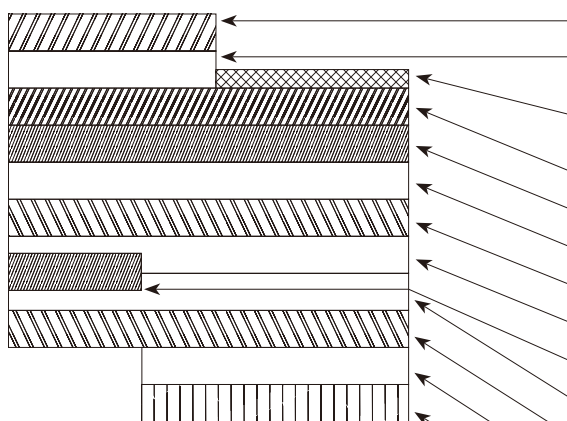

### FPC : Flexible Printed Circuit

Layer	Materials	Thickness (μm)
Cover Lay Film	Polymide 1mil	(25)
Cover Adhesive		(25)
Surface Treatment	Nickel Under Plating 1~5μm+ Gold Plating 0.2μm	3
Through Hole Copper	Cu	15
Copper Foil	Cu 1/2oz	18
Base Adhesive	Heat Stiffener Adhesive	18
Base Film	Polymide 1mil	25
Base Adhesive	Heat Stiffener Adhesive	18
Copper Foil	Cu 1/2oz	(18)
Cover Adhesive	Heat Stiffener Adhesive	25
Cover Lay Film	Polymide 1mil	25
Stiffener Adhesive	Heat Stiffener Adhesive	50
Reinforcing Film	Polymide 4mil	100
Total		297

\* Remove the copper foil on the back of double-sided FPC to avoid damage due to FPC bending.

### 3. FFC

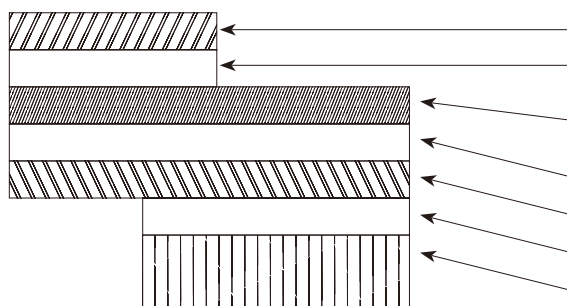

### FFC : Flexible Flat Cable

Layer	Materials	Thickness (μm)
Polyester Film		12
Adhesive	Polyester Thermal Plasticity	30
Annealed Copper Foil (Gold Plated with Nickel Under Plating)		35
Adhesive	Polyester Type	30
Polyester		12
Adhesive	Polyester Type	30
Reinforcing Film	Polyester Type	188
Total		295

Nominal thickness tolerance is approximately  $\pm 20\mu\text{m}$ .

1. These specifications are an example of the material configuration of an FPC/FFC ( $t = 0.3 \pm 0.05$ ) used on the FH28K series.
2. Please contact the FPC/FFC manufacturer for the material configurations of their FPC/FFC.

## ◆ Packaging Specifications

### ● Embossed Carrier Tape Dimensions (with a maximum tape width of 24mm)

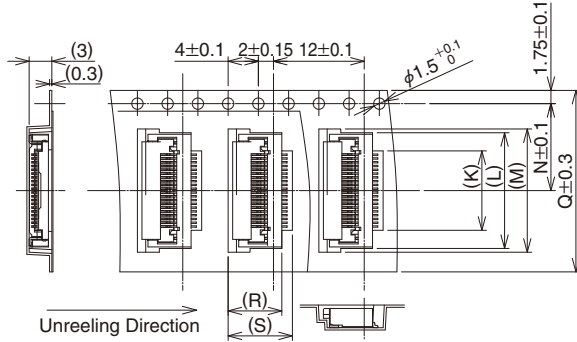

### ● Embossed Carrier Tape Dimensions (with a maximum tape width of 32mm)

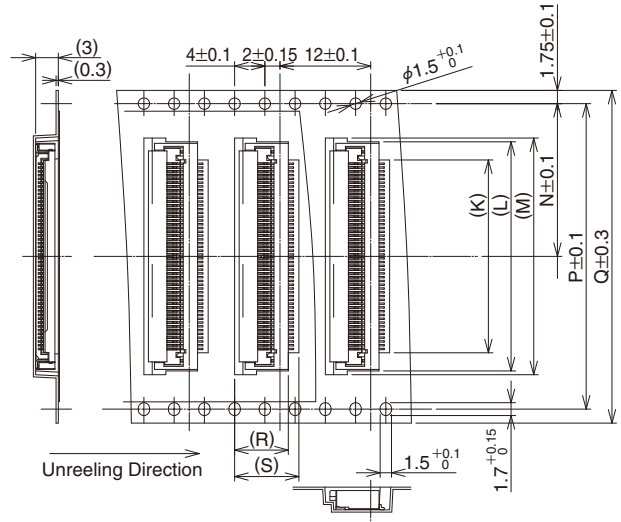

### ● Reel Dimensions

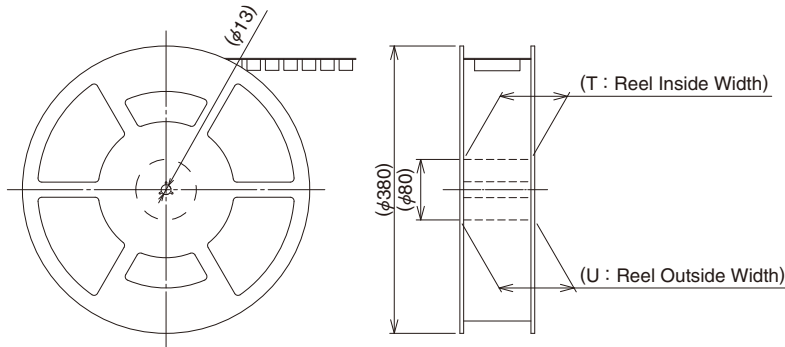

### ● Leader, Trailer Dimensions

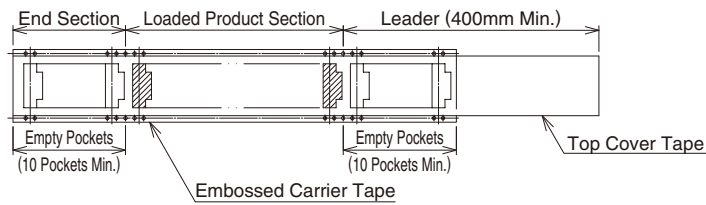



### ◆ Packaging specification dimensions for 0.5mm pitch products

Unit : mm

Part No.	HRS No.	No. of Pos.	K	L	M	N	P	Q	R	S	T	U
FH28K-10S-0.5SH(**)	586-1876-0 **	10	5.5	10.3	11.3	11.5	—	24	7.1	8.5	25.4	29.4
FH28K-15S-0.5SH(**)	586-1883-0 **	15	8	12.8	13.8	11.5	—	24	7.1	8.5	25.4	29.4
FH28K-20S-0.5SH(**)	586-1879-0 **	20	10.5	15.3	16.3	11.5	—	24	7.1	8.5	25.4	29.4
FH28K-28S-0.5SH(**)	586-1880-0 **	28	14.5	19.3	20.3	14.2	28.4	32	7.1	8.5	33.4	37.4
FH28K-30S-0.5SH(**)	586-1877-0 **	30	15.5	20.3	21.3	14.2	28.4	32	7.1	8.5	33.4	37.4
FH28K-40S-0.5SH(**)	586-1878-0 **	40	20.5	25.3	—	20.2	40.4	44	7.1	8.5	45.4	49.4
FH28K-45S-0.5SH(**)	586-1884-0 **	45	23	27.8	28.8	20.2	40.4	44	7.1	8.5	45.4	49.4
FH28K-50S-0.5SH(**)	586-1875-0 **	50	25.5	30.3	—	20.2	40.4	44	7.1	8.5	45.4	49.4
FH28K-55S-0.5SH(**)	586-1881-0 **	55	28	32.8	—	20.2	40.4	44	7.1	8.5	45.4	49.4
FH28K-60S-0.5SH(**)	586-1872-0 **	60	30.5	35.3	36.3	26.2	52.4	56	7.1	8.5	57.4	61.4
FH28K-64S-0.5SH(**)	586-1882-0 **	64	32.5	37.3	—	26.2	52.4	56	7.1	8.5	57.4	61.4
FH28K-68S-0.5SH(**)	586-1873-0 **	68	34.5	39.3	40.3	26.2	52.4	56	7.1	8.5	57.4	61.4
FH28K-74S-0.5SH(**)	586-1885-0 **	74	37.5	42.3	43.3	26.2	52.4	56	7.1	8.5	57.4	61.4
FH28KH-80S-0.5SH(**)	586-1874-0 **	80	40.5	45.3	46.3	26.2	52.4	56	6.6	8	57.4	61.4

### ◆ Packaging specification dimensions for 1mm pitch products

Unit : mm

Part No.	HRS No.	No. of Pos.	K	L	M	N	P	Q	R	S	T	U
FH28K-20(10)SB-1SH(**)	—	10	10.5	15.3	16.3	11.5	—	24	7.1	8.5	25.4	29.4
FH28K-30(15)SB-1SH(**)	—	15	15.5	20.3	21.3	14.2	28.4	32	7.1	8.5	33.4	37.4
FH28K-40(20)SB-1SH(**)	—	20	20.5	25.3	—	20.2	40.4	44	7.1	8.5	45.4	49.4
FH28K-50(25)SB-1SH(**)	—	25	25.5	30.3	—	20.2	40.4	44	7.1	8.5	45.4	49.4
FH28K-60(30)SB-1SH(**)	—	30	30.5	35.3	36.3	26.2	52.4	56	7.1	8.5	57.4	61.4
FH28K-64(32)SB-1SH(**)	—	32	32.5	37.3	—	26.2	52.4	56	7.1	8.5	57.4	61.4
FH28K-68(34)SB-1SH(**)	—	34	34.5	39.3	40.3	26.2	52.4	56	7.1	8.5	57.4	61.4

Note : Contact positions without HRS No. are currently planned for development.  
Please contact Hirose for detailed information about product variation.

### ◆ Recommended soldering profile

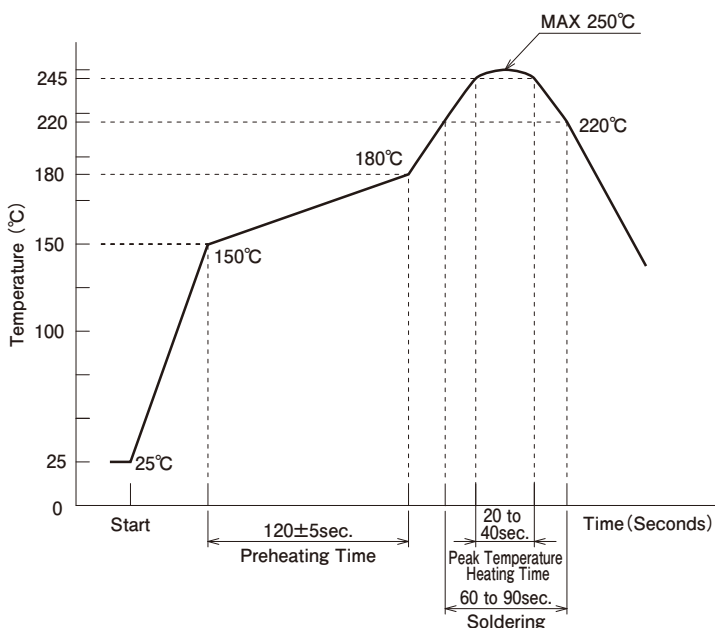

#### Applicable Conditions

- Reflow type : Far red/hot air reflow
- Reflow furnace atmosphere : Atmosphere
- Reflow soldering : 2 cycles Max.
- Soldering : Cream type  
Sn/3.0Ag/0.5Cu  
(M705-GRN360-K2-V made by Senju Metal Industry Co.)
- Testing PCB : PCB material and size  
Glass epoxy 80×100×1.6mm  
Land size, per recommended PCB layout.
- Metal mask : Thickness and opening size  
per recommended metal mask dimensions



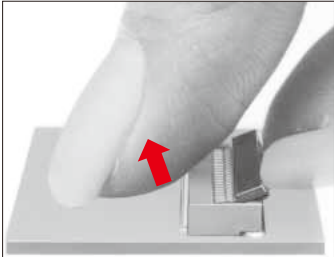
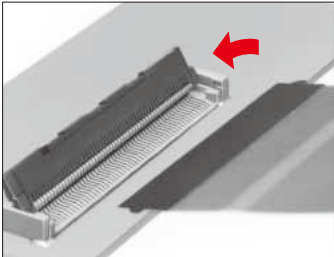
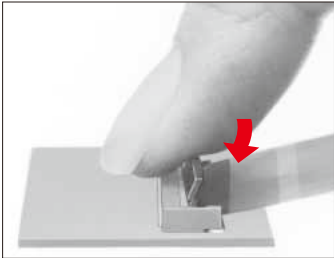
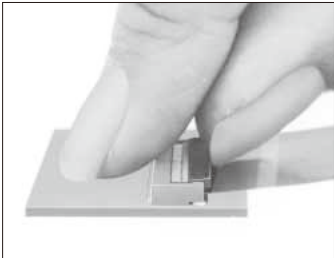
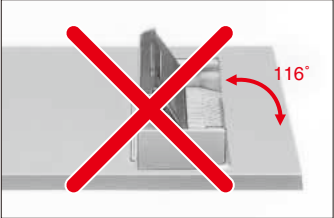
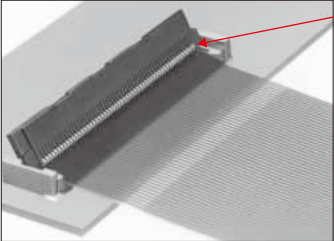
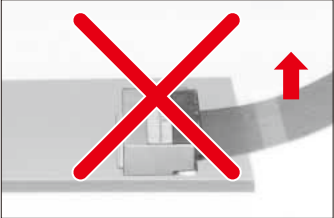
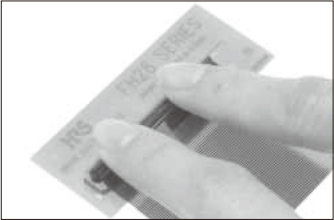
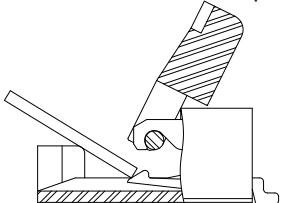

This solder profile is based on the conditions provided above.  
Please check the mounting conditions before use. Conditions such as solder paste types, manufacturer, PCB size and any other soldering materials may alter the performance of such materials.

## ◆ Operation Methods of Connector and Precautions

Operation Method	Usage Precautions
<p><b>1. FPC/FFC Insertion Method</b></p> <p>① Rotate the actuator upward unlock. The actuator can be easily operated with the use of a thumb nail or index finger.</p>  <p>② Insert the FPC/FFC with the contact surface facing down. Insert the FPC/FFC at an angle from above the connector. Insert until it is securely held in positioning portion of connector. Lightly pull on the FPC/FFC to confirm it is held in place. Refer to the next page for further details.</p>  <p>③ Rotate the actuator downward.</p>  <p><b>2. FPC/FFC Removal</b></p> <p>① Rotate the actuator upward, then lift the FPC/FFC upward after the actuator has been released and pull the FPC/FFC out.</p> 	<p>① The actuator on the FH28K Series connector is designed to open to a maximum of 116 degrees, trying to open it farther than that will lead to damage.</p>  <p>② Insert the FPC/FFC into the insertion slot as show below. Improper insertion may result in FPC/FFC damage or conduction failure.</p>  <p>③ This connector is not designed to withstand a large amount of force in the upward direction. Secure the FPC/FFC if a force will be applied.</p>  <p>④ When inserting an FPC/FFC to a connector with a high pin count (80pos.), please use two fingers to close the actuator on both sides. Using one finger to press on the center of the actuator may result in incomplete actuator closing.</p>  <p>⑤ When inserting FPC/FFC, do not rub against the underside of the connector insertion port. Otherwise, the contact and FPC/FFC will strongly hit against each other which may result in contact deformation or FPC/FFC conductor peeling.</p> 

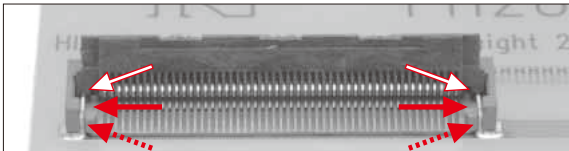
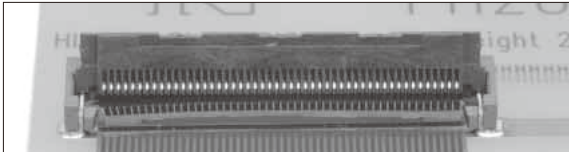
Apr. 1. 2024 Copyright 2024 HIROSE ELECTRIC CO., LTD. All Rights Reserved.

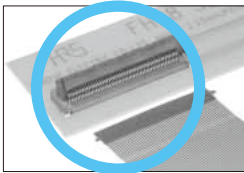
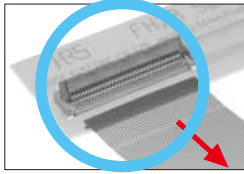
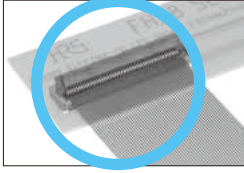
## ◆ Cautions when Mating FFC/FPC with Positioning Tabs

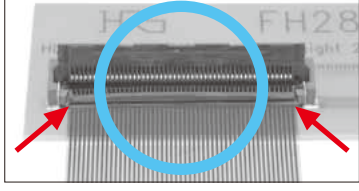
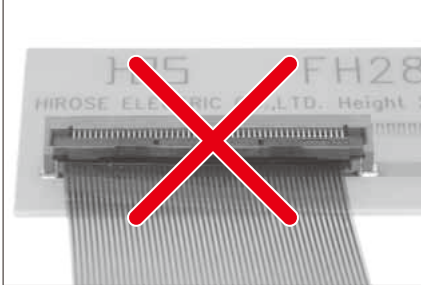
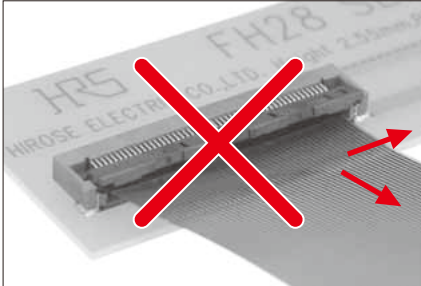
Operation Method	Usage Precautions
<p><b>1. Insertion Position</b></p> <p>Insert the cable so that the positioning tabs are secured into the gap (→) between the molded walls on both sides of the connector (.....▶) and the guide walls on both sides of the connector interior (⇒).</p>   <p><b>2. Cautions during Insertion/Mating</b></p> <p>① Do not insert the cable at a skewed angle. The cable corner may get caught in the terminal resulting in contact deformation.</p> <p>Skewed Insertion</p>  <p>Insert the cable straight into the connector opening and hook the cable tab onto the guide. Pull the cable towards yourself with a slight force after insertion, and close the actuator after confirming that the cable tab is completely secured. If it cannot be pulled to out, the cable is inserted in the correct position.</p> <p>Recommended Mating Method</p>  <p>① Insert the cable straight from above the connector at an angle.</p>  <p>② Pull the cable lightly towards yourself and check if the tab is secured.</p> <p>Pulling Direction</p>  <p>③ Close the actuator.</p>	<p>② FPC/FFC must not overlap</p> <p>Do not close the actuator until the FPC/FFC has been placed into its correct position. If it is sitting on the guides and the actuator closes onto it, it can cause damage and conduction failure.</p> <p>Overlapping on Left Guide</p>  <p>Overlapping on Right Guide</p>  <p>Normal Insertion</p>  <p>Closing the actuator with the cable sitting on the guide.</p>  <p>In case you accidentally close the lock with the cable sitting on the guides, do not move the cable around. Open the actuator immediately and reposition the cable as explained in "1. Insertion Position" noted above.</p> <p>Moving the cable after closing the actuator with the cable sitting on the guide.</p> 

Apr. 1. 2024 Copyright 2024 HIROSE ELECTRIC CO., LTD. All Rights Reserved.



---

**HIROSE ELECTRIC CO.,LTD.**  
2-6-3,Nakagawa Chuoh,Tsuzuki-Ku,Yokohama-Shi 224-8540,JAPAN  
<https://www.hirose.com/>

---