

# High-Speed(10+Gbps) BGA Mezzanine Connectors

## IT3 Series

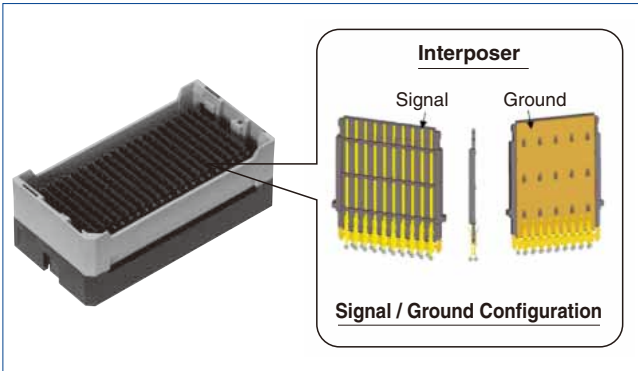
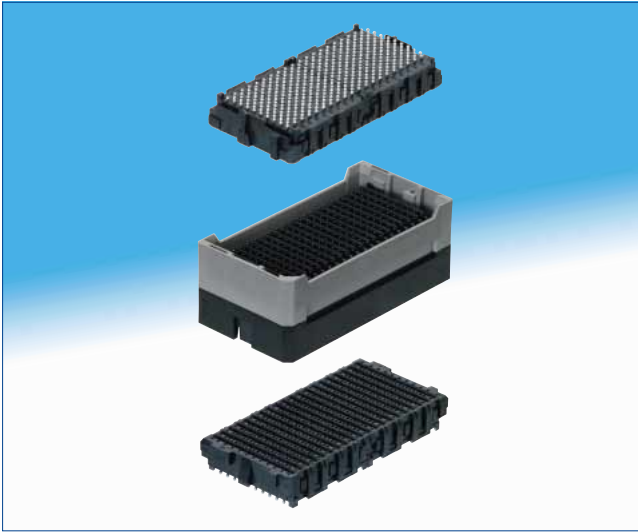

### Flexibility

Hirose's IT3 mezzanine connector system is as comfortable in today's data rates of PCIe and XAUI as it is in tomorrow's 10+Gbps systems. With the ability to transmit differential, single-ended, and power through one package and being stackable from 17 to 42mm, IT3 can solve your interface needs for both current and future generations.

### Mechanical features

- Unique 3-piece structure for flexibility
- Stacking heights from 17 to 42mm
- Staggered 1.5mm × 1.75mm ball grid array
- Number of Contacts: 100, 200, &300 signals + 90% additional grounds
- Differential, single-ended, and power
- Low mating/extracting forces
- Wide misalignment tolerances for multiple connector use
- Pb-free are available
- Excellent reflow solderability

### Signal integrity features

#### Insertion loss to Crosstalk Ratio (ICR)

The ICR performance meets the extrapolated IEEE 802.3ap specification for 6.25Gbps with fully-populated pin assignment, and 10+Gbps with skipped pin assignment.

#### Return Loss

The differential return loss meets the extrapolated IEEE 802.3ap specification up to 12GHz.

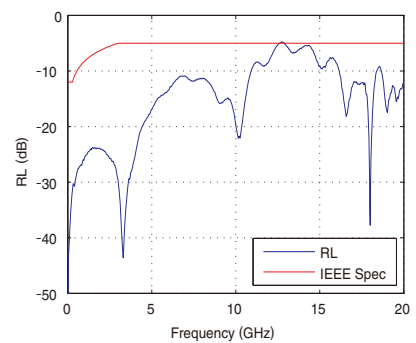
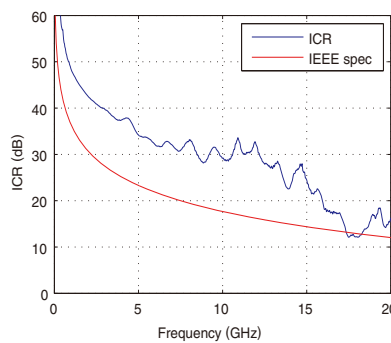

### Stacking height variations

Stacking Height	17 mm	18 mm	19 mm*	20 mm	21 mm*	22 mm	23 mm*	24 mm*	25 mm	26 mm	27 mm*	28 mm	29 mm*	30 mm*	31 mm*	32 mm	33 mm*	34 mm*	35 mm	36 mm*	37 mm*	38 mm	39 mm*	40 mm	41 mm*	42 mm*	
No. of Pos.																											
100	✓	✓	✓	✓	✓	✓	✓	✓	✓	✓	✓	✓	✓	✓	—	✓	✓	✓	✓	✓	✓	✓	✓	✓	✓	✓	✓
200	✓	✓	✓	✓	✓	✓	✓	✓	✓	✓	✓	✓	✓	✓	✓	✓	✓	✓	✓	✓	✓	✓	✓	—	—	—	—
300	✓	✓	✓	✓	✓	✓	✓	✓	✓	✓	✓	✓	✓	✓	✓	✓	✓	✓	✓	✓	✓	✓	✓	✓	✓	✓	✓

\*Mated with IT5 Series receptacle.

## ■Product Specifications

Rating	Current Rating : 0.5A / pin (note 1)	Operating Temperature Range : -55°C to +85°C
	Voltage Rating : 50Vrms	Operating Humidity Range : For relative humidity, 90% max (no condensation is permitted)
	Storage Temperature Range : -10°C to +60°C	

Item	Specification	Conditions
1. Insulation Resistance	1000MΩ min.	100V DC
2. Withstanding Voltage	No flashover or insulation breakdown	150V duty for 60 seconds (2mA max leak)
3. Contact Resistance	50mΩ max. (height 17-24mm) (note 2) 55mΩ max. (height 25-32mm) (note 2) 60mΩ max. (height 33-42mm) (note 2)	100mA
4. Vibration	1) No electrical discontinuity of 1μs or more 2) No damage, crack, or loose part	Frequency : 50 to 2000Hz ; power spectrum density : 0.1G <sup>2</sup> /Hz for 90 minutes in three directions
5. Cyclic Temperature and Humidity	1) Contact resistance change : 20mΩ or less 2) No damage, crack or loose part	25°C, 80% RH : 60 min dwell time, 30 min ramp time 65°C, 50% RH : 60 min dwell time under 24 cycles
6. Durability (Mating/Un-mating)	1) Contact resistance change : 20mΩ or less 2) No damage, crack or loose part	100 cycles

Note1 : Refer to IT3 derating curves on test report TR636E-20041 for power application.

Note2 : The value of contact resistance includes 2 contact points and the bulk resistance.

## ■Materials / Finish

### ●Receptacle

Component	Material	Finish & Remarks
Housing(Mounting Side)	LCP	Black , UL 94V-0
Housing(Detachable / Mating Side)	LCP	Gray , UL 94V-0
Locator	LCP	Black , UL 94V-0
Contact	Copper Alloy	Contact Area : Gold (0.76μm) over Nickel (1.5μm) Mounting Area : Gold (0.05μm) over Nickel (1.5μm) Other : Nickel (1.5μm)
Solder Ball	Tin (Pb-Free)	Sn(96.5)-Ag(3)-Cu(0.5)
Tray	Polystyrene	Black
Pick Up Cap	Stainless steel	300pos
Pick Up Tape	Paper (Nomex)	100pos and 200pos

### ●Interposer

Component	Material	Finish & Remarks
Guide (Mounting Side)	PBT	Black , UL 94V-0
Guide (Detachable/Mating Side)	LCP	Gray , UL 94V-0
	PBT	Gray , UL 94V-0
Blade	LCP	Black , UL 94V-0
Contact	Copper Alloy	Contact Area : Gold (0.76μm) over Nickel (1.5μm) Other : Nickel (1.5μm)
Ground Shield	Copper Alloy	
Tray	Polypropylene	—

## Product Number Structure

Refer to the chart below when determining the product specifications from the product number. Please select from the product numbers listed in this catalog when placing orders.

### ● Receptacle

IT 3
\*\*
- \*\*\*
S
- BGA
\*\*
(\*\*)

1
2
3
4
5
6
7

### ● Interposer

IT 3
\*\*
- \*\*\*
P
- \*\*
H
\*\*
(\*\*)

1
2
3
4
8
6
9

<p><b>1</b> Series name : IT3</p> <p><b>2</b> Receptacle Type                  D : Mating Receptacle                  D* : Mating Receptacle ( Customized )                  M : Mounting Receptacle                  M* : Mounting Receptacle ( Customized )                  Interposer Type                  Blank : Standard                  ** : Customized</p> <p><b>3</b> Contact Positions : 100, 200, 300</p> <p><b>4</b> Connector type                  S : Receptacle                  P : Interposer</p> <p><b>5</b> BGA : Ball Grid Array</p> <p><b>6</b> Package Specification                  Blank : Standard                  ** : Customized</p>	<p><b>7</b> Material and Plating Specification of Mounting Receptacle                  Housing : Black                  (37) : Pb-free Solder Sn(96.5)-Ag(3.0)-Cu(0.5)                  Contact Area : Au(0.76μm)+Ni(1.5μm)                  Material and Plating Specification of Mating Receptacle                  Housing : Glay                  (39) : Pb-free Solder Sn(96.5)-Ag(3.0)-Cu(0.5)                  Contact Area : Au(0.76μm)+Ni(1.5μm)</p> <p><b>8</b> Stacking Height (mm)                  17, 18, 19, 20, 21, 22, 23, 24, 25, 26, 27, 28, 29, 30,                  31, 32, 33, 34, 35, 36, 37, 38, 39, 40, 41, 42                  Interposer : 17 to 40</p> <p><b>9</b> Plating Specification of Interposer                  (03), (04) : Contact Area : Au(0.76μm)+Ni(1.5μm)</p>
---	--

## Signal Integrity

### ● Pin assignment

For the fully-populated pin assignment, adjacent pins are grouped into differential pairs as shown in the figures below. In the following data, one victim pair and eight aggressor pairs are included.

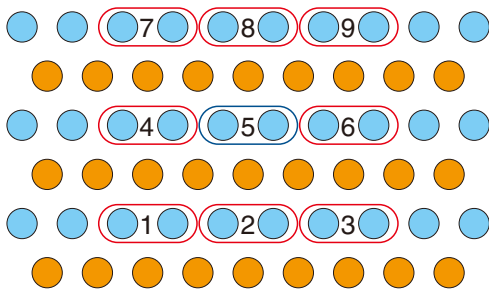

Mating receptacle side

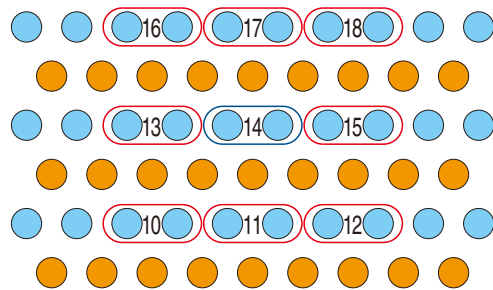

Mounting receptacle side



● Impedance profile at 60ps rise time (20-80%)

The impedance profiles (of connector only) for the center pair are shown below. The IT3 receptacles are designed with higher impedance to offset the via's low impedance.

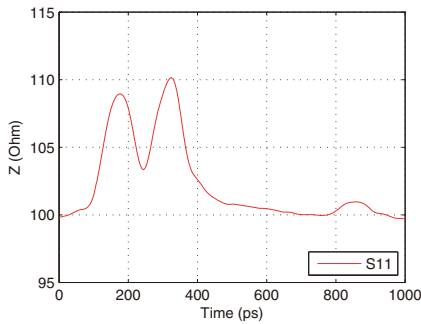

17mm Height

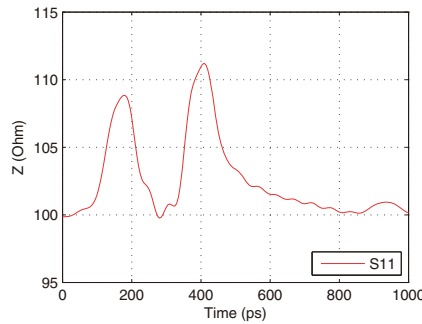

25mm Height

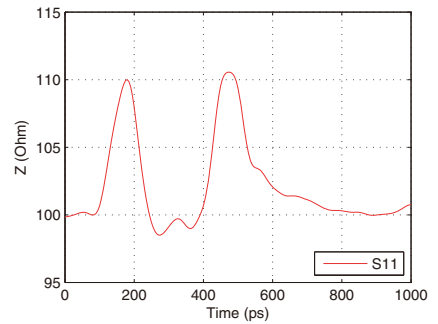

32mm Height

● Differential propagation delay

Stacking Height (mm)	17	25	32
Delay (ps)	101.05	146.69	188.48

● Differential Insertion Loss

The differential insertion loss is less than -2dB up to 12GHz.

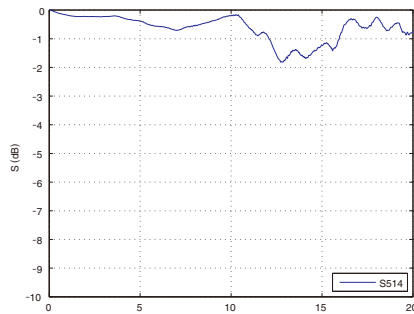

17mm Height

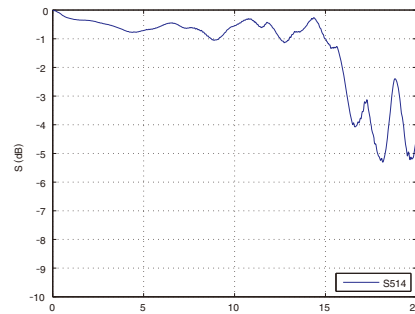

25mm Height

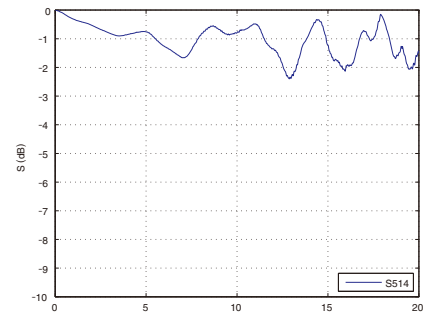

32mm Height

● Differential Return Loss

The connector-only differential return loss for the center pair meets the extrapolated IEEE 802.3ap spec up to 12GHz. (The attenuation of PCB traces in the channel will give an even larger margin.)

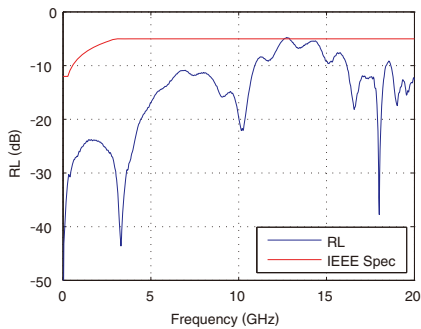

17mm Height

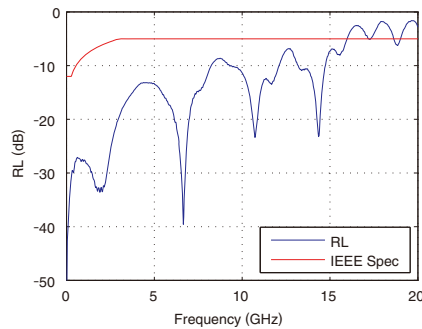

25mm Height

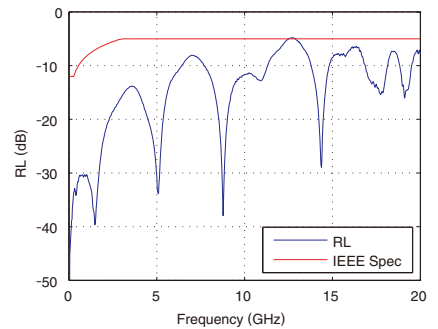

32mm Height

Mar.1.2026 Copyright 2026 HIROSE ELECTRIC CO., LTD. All Rights Reserved.

● **Differential Near-End Crosstalk (NEXT)**

The near-end crosstalk at the center pair from surrounding 8 aggressors is shown below. The NEXT is not as critical because TX and RX can be grouped into separate wafers.

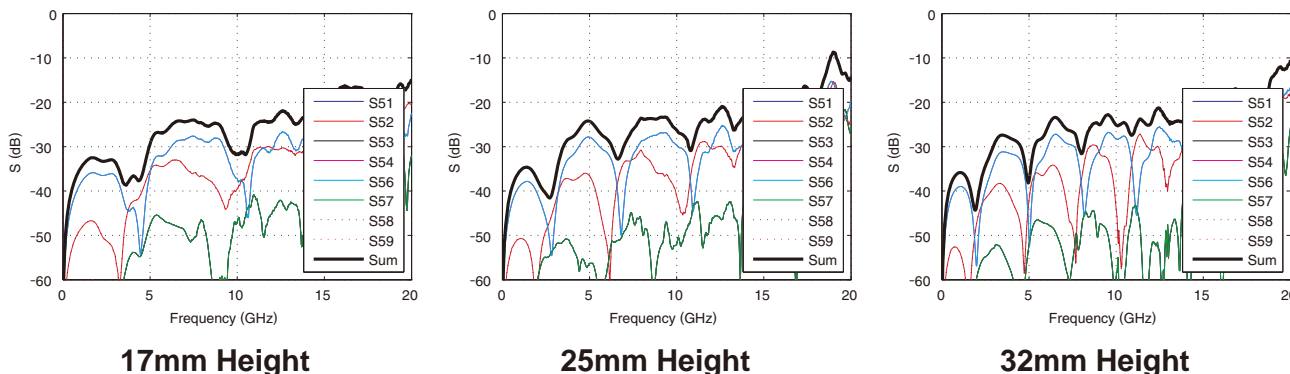

● **Differential Far-End Crosstalk (FEXT)**

Low far-end crosstalk at the center pair from surrounding 8 aggressors is observed. Even lower crosstalk can be achieved by skipping pins.

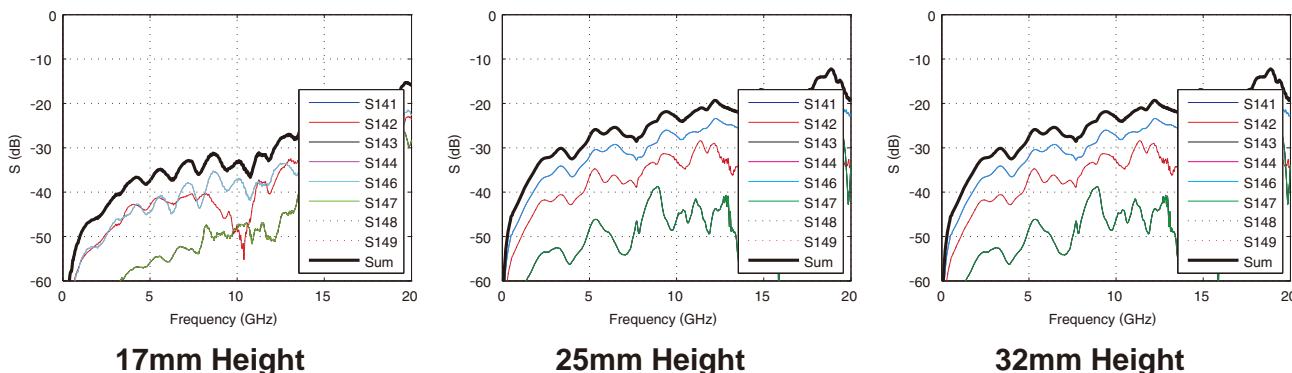

● **Insertion-Loss-to-Crosstalk-Ratio (ICR) for FEXT**

The insertion-loss-to-crosstalk-ratio (ICR) for 8-aggressor FEXT meets the extrapolated IEEE 802.3ap specification up to 12GHz.

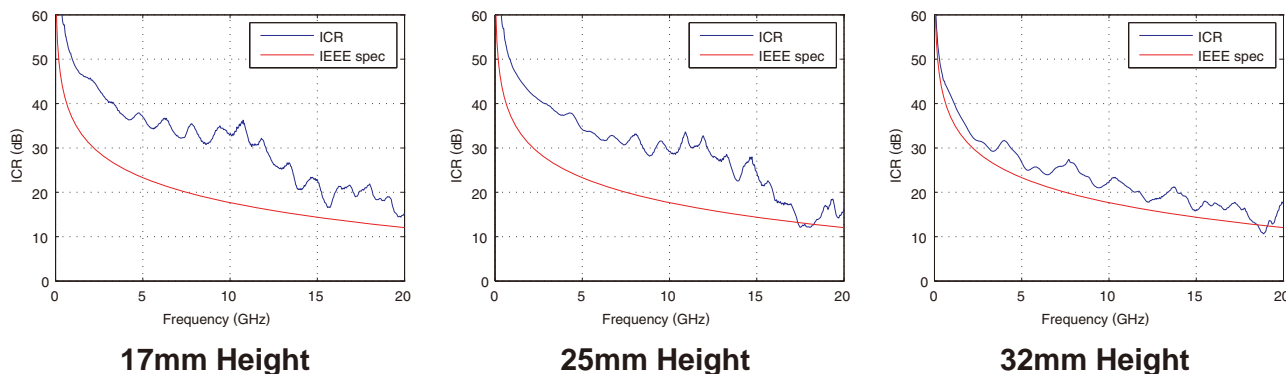

● Refer to IT5 Series for higher density and higher transmission speed needs.

Mar.1.2026 Copyright 2026 HIROSE ELECTRIC CO., LTD. All Rights Reserved.

## ■ Receptacle

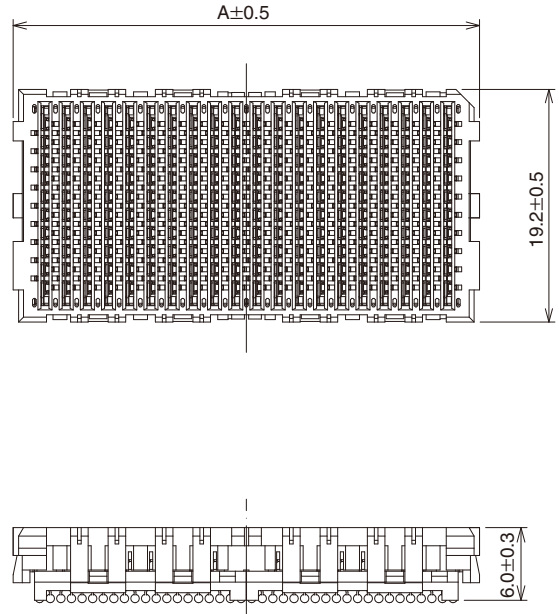

Shown: 200 position mounting receptacle, IT3M-200S-BGA

\*Unit : mm

Contact Positions	Type	Solder Ball Material	Part No.	HRS No.	A
100 (100 signals/90 grounds)	Mating Receptacle	Pb-free (SAC305) solder	IT3D-100S-BGA(39)	636-0013-1 39	21.0
	Mounting Receptacle	Pb-free (SAC305) solder	IT3M-100S-BGA(37)	636-0014-4 37	
200 (200 signals/180 grounds)	Mating Receptacle	Pb-free (SAC305) solder	IT3D-200S-BGA(39)	636-0003-8 39	38.5
	Mounting Receptacle	Pb-free (SAC305) solder	IT3M-200S-BGA(37)	636-0004-0 37	
300 (300 signals/270 grounds)	Mating Receptacle	Pb-free (SAC305) solder	IT3D-300S-BGA(39)	636-0007-9 39	56.0
	Mounting Receptacle	Pb-free (SAC305) solder	IT3M-300S-BGA(37)	636-0008-1 37	

## Interposer

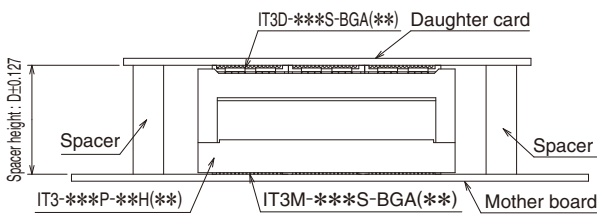
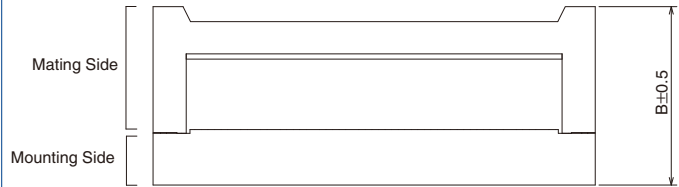
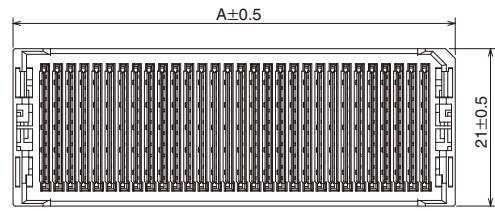
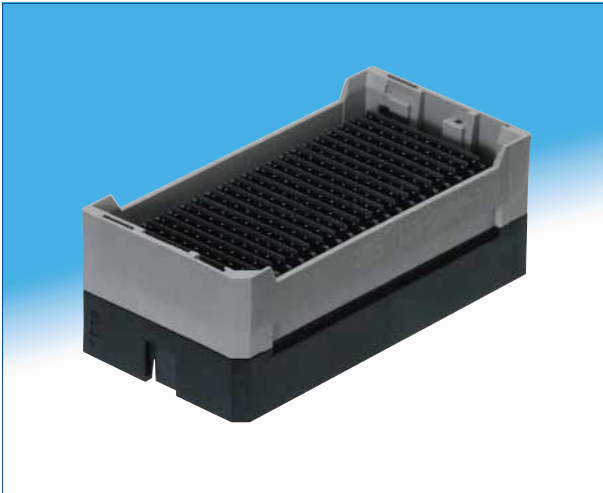

Mating condition with spacers

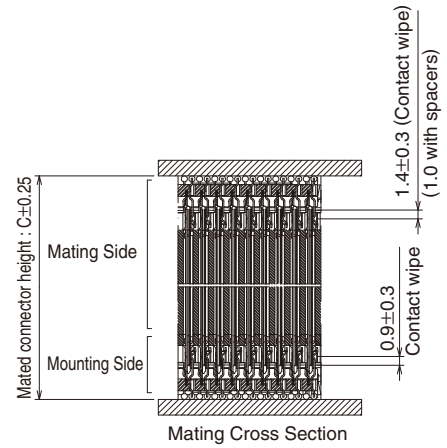

Mating condition without spacers

\*Unit : mm

Height (mm)	Part No.	HRS No.	A	B	C	D	Height (mm)	Part No.	HRS No.	A	B	C	D
17	IT3-100P-17H(04)	636-0265-4 04	24.0	15.8	16.6	17.0	28	IT3-100P-28H(04)	636-0170-0 04	24.0	26.8	27.6	28.0
	IT3-200P-17H(04)	636-0100-4 04	41.5					IT3-200P-28H(04)	636-0105-8 04	41.5			
	IT3-300P-17H(04)	636-0130-5 04	59.0					IT3-300P-28H(04)	636-0140-9 04	59.0			
18	IT3-100P-18H(03)	636-0250-7 03	24.0	16.8	17.6	18.0	30	IT3-200P-30H(04)	636-0180-3 04	41.5	28.8	29.6	30.0
	IT3-200P-18H(03)	636-0252-2 03	41.5					IT3-300P-30H(04)	636-0185-7 04	59.0			
	IT3-300P-18H(03)	636-0254-8 03	59.0					IT3-100P-32H(04)	636-0266-7 04	24.0			
20	IT3-100P-20H(03)	636-0223-4 03	24.0	18.8	19.6	20.0	32	IT3-200P-32H(04)	636-0115-1 04	41.5	30.8	31.6	32.0
	IT3-200P-20H(03)	636-0224-7 03	41.5					IT3-300P-32H(04)	636-0145-2 04	59.0			
	IT3-300P-20H(03)	636-0225-0 03	59.0					IT3-100P-35H(03)	636-0239-4 03	24.0			
22	IT3-100P-22H(03)	636-0264-1 03	24.0	20.8	21.6	22.0	35	IT3-200P-35H(03)	636-0240-3 03	41.5	33.8	34.6	35.0
	IT3-200P-22H(03)	636-0209-3 03	41.5					IT3-300P-35H(03)	636-0241-6 03	59.0			
	IT3-300P-22H(03)	636-0210-2 03	59.0					IT3-100P-38H(03)	636-0200-9 03	24.0			
25	IT3-100P-25H(04)	636-0150-2 04	24.0	23.8	24.6	25.0	38	IT3-200P-38H(03)	636-0195-0 03	41.5	36.8	37.6	38.0
	IT3-200P-25H(04)	636-0155-6 04	41.5					IT3-300P-38H(03)	636-0190-7 03	59.0			
	IT3-300P-25H(04)	636-0160-6 04	59.0					IT3-100P-40H(03)	636-0230-0 03	24.0			
26	IT3-100P-26H(04)	636-0165-0 04	24.0	24.8	25.6	26.0	40	IT3-200P-40H(03)	636-0230-0 03	24.0	38.8	39.6	40.0
	IT3-300P-26H(04)	636-0135-9 04	59.0					IT3-300P-40H(03)	636-0175-3 03	59.0			

### PCB footprint (mounting foot pattern)

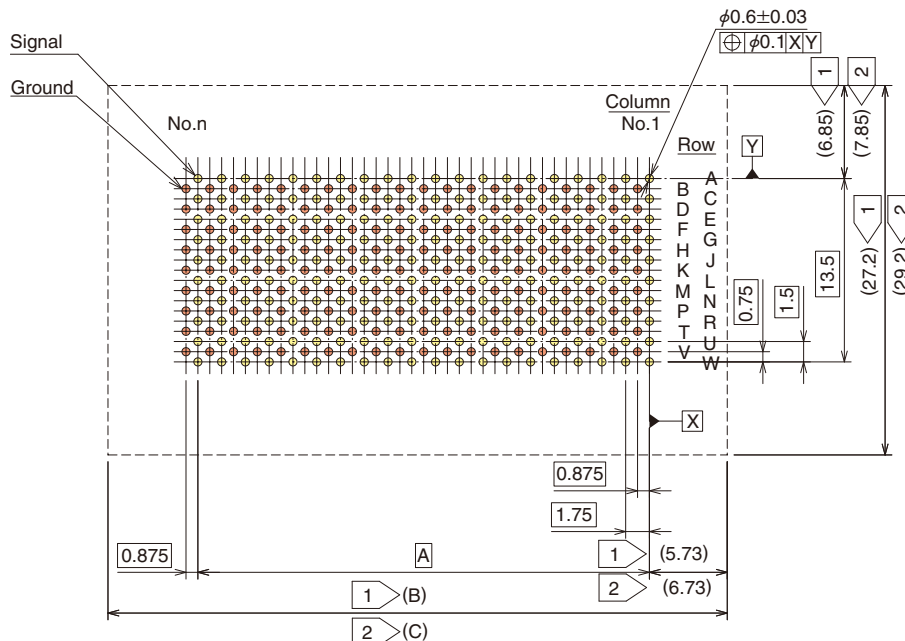

**Mounting Receptacle - IT3M Plug**

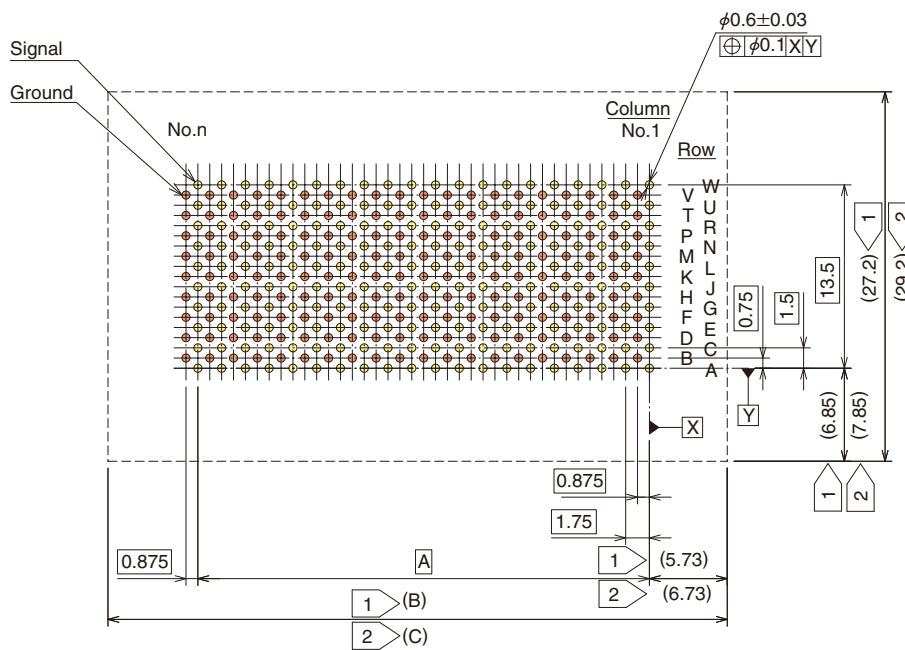

**Mating Receptacle - IT3D**

- 1 Minimum clearance for all devices
- 2 Minimum clearance for sensitive devices

\*Unit : mm

Dimension	100	200	300
A	15.75	33.25	50.75
B	28.10	45.60	63.10
C	30.10	47.60	65.10

### ◆ Spacers

Spacers are required to support the PWB's and protect the BGA solder joints.

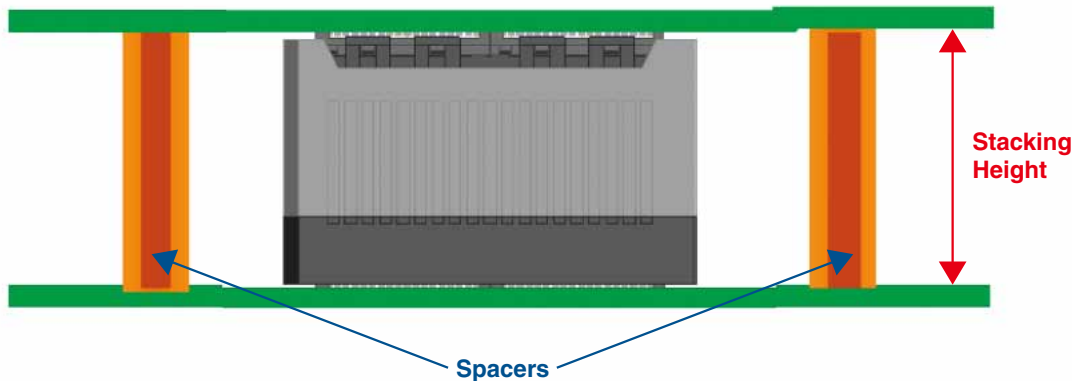

Suggested spacer style is shown below :



Spacer, male-male, M3 thread

The recommended spacer height corresponds to the interposer stacking height as shown in the chart below :

Stacking Height	Recommended Spacer Height	Stacking Height	Recommended Spacer Height
17 mm	17 +/-0.127 mm	31 mm	31 +/-0.127 mm
18 mm	18 +/-0.127 mm	32 mm	32 +/-0.127 mm
19 mm	19 +/-0.127 mm	33 mm	33 +/-0.127 mm
20 mm	20 +/-0.127 mm	34 mm	34 +/-0.127 mm
21 mm	21 +/-0.127 mm	35 mm	35 +/-0.127 mm
22 mm	22 +/-0.127 mm	36 mm	36 +/-0.127 mm
23 mm	23 +/-0.127 mm	37 mm	37 +/-0.127 mm
24 mm	24 +/-0.127 mm	38 mm	38 +/-0.127 mm
25 mm	25 +/-0.127 mm	39 mm	39 +/-0.127 mm
26 mm	26 +/-0.127 mm	40 mm	40 +/-0.127 mm
27 mm	27 +/-0.127 mm	41 mm	41 +/-0.127 mm
28 mm	28 +/-0.127 mm	42 mm	42 +/-0.127 mm
29 mm	29 +/-0.127 mm		
30 mm	30 +/-0.127 mm		

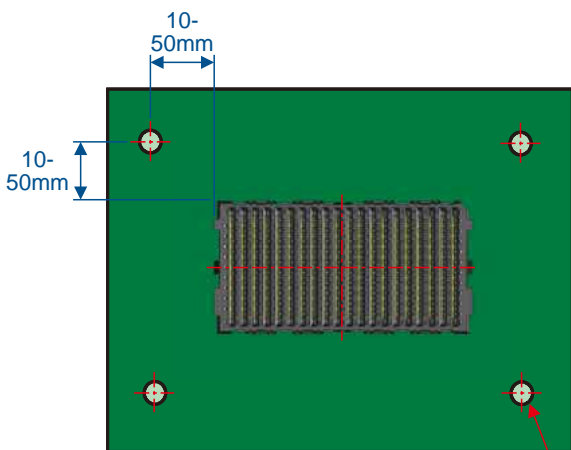

Recommended Spacer Location

φ3.5  
Non plated through hole

Two spacers located diagonally are minimally required. Some applications may require 4 spacers. Spacers should be located 10 – 50 mm from the corners of the receptacles to prevent excessive mechanical loading on the interconnections. If assembly will be subjected to vibration, spacers should be located to prevent resonance, and additional spacers may be required.

### ◆ Interposer installation

Position interposer directly over mounting receptacle, aligning the polarity chamfers. If positioned properly, the interposer should slide easily onto the mounting receptacle. Place installation cap onto interposer and push straight down to engage the locking latches.

#### Manual Installation

\*Installation caps are available upon request for manual operation

Press firmly on installation cap only, not on wafers or interposer body

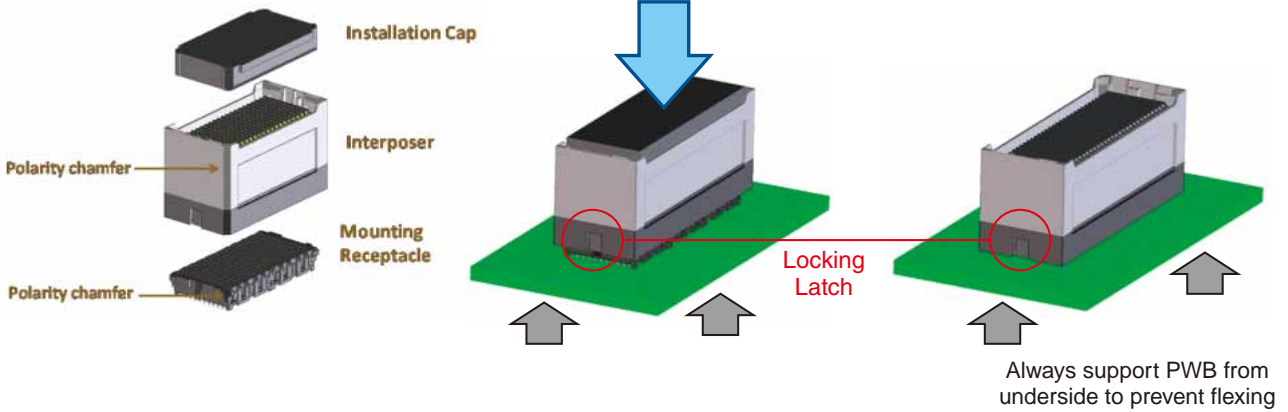

### ◆ Daughter card installation

After the interposer is mounted, install spacers onto motherboard. To install mating receptacle, align the spacer holes in the daughter card with the threads on the spacers.

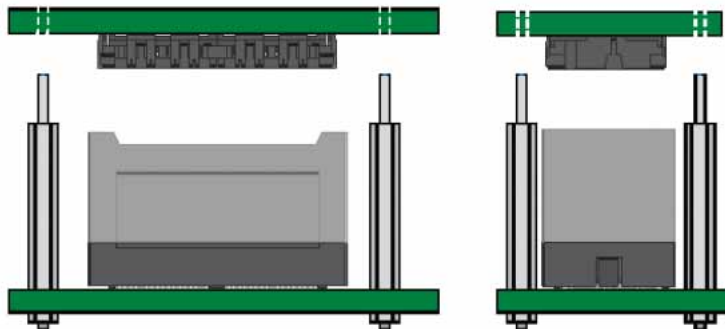

The spacers help align the mating receptacle with the interposer. If positioned correctly, the mating receptacle will slip down into the interposer. Push directly down on the assembly to lock the mating receptacle in place. Install nuts onto the spacer threads. Tighten nuts to specified torque.

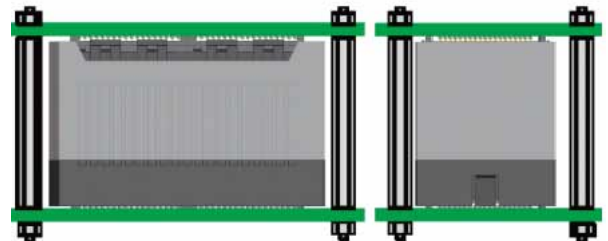

### ◆ Daughter card removal

To remove a daughter card, first remove the nuts from the reinforcing spacers, then lift the daughter card straight off the interposers, as shown right.

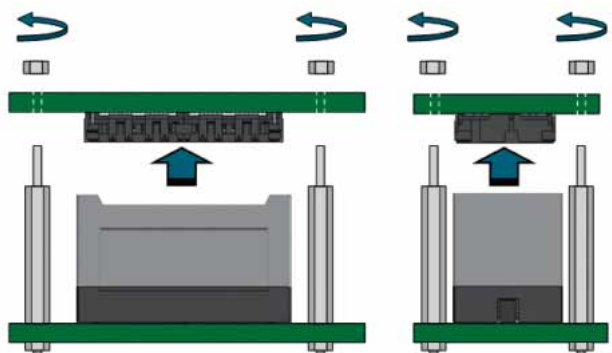

## ◆ Interposer removal

### Interposer Removal by Hand

- 1) Hold the Interposer Assembly on the walls without locking latches



- 2) Gently rotate one side of the Interposer Assembly laterally 10° maximum



**Caution:** do not rotate more than 10 degrees

- 3) While gently rotating, pull up on other side of the Interposer Assembly



- 4) The Interposer Assembly is removed, and the Mounting Receptacle is ready to accept another Interposer Assembly.

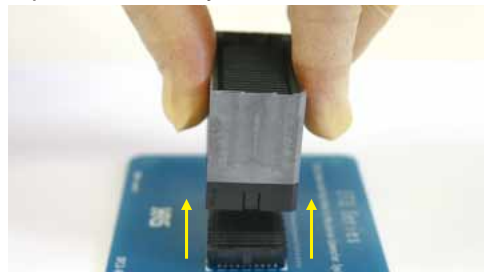

An interposer removal tool is also available. This tool is not an interposer installation cap, so please do not use it to install an interposer. Doing so may damage an interposer.

### Interposer Removal with Tool

- 1) Cover the interposer Assembly with the interposer removal tool

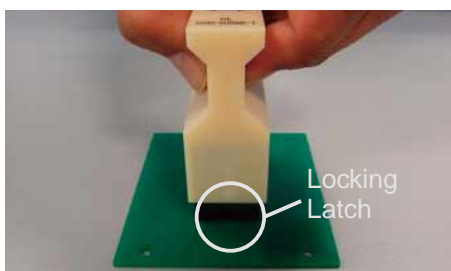

- 2) Gently rotate one side of the Interposer Assembly laterally 10° maximum using the tool

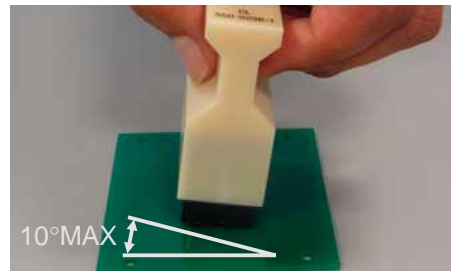

**Caution:** do not rotate more than 10 degrees

- 3) While gently rotating, pull up on other side of the tool

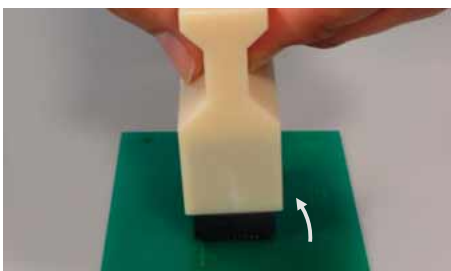

- 4) The Interposer Assembly is removed, as it is inside the tool

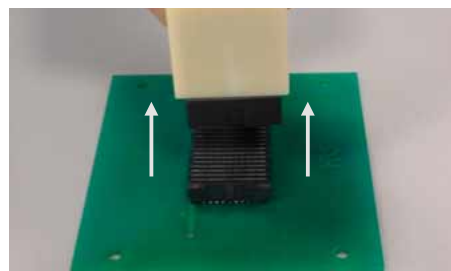

#### **Precaution**

Visually inspect the interposer before reinstalling it. Discard if it shows any sign of damage or wear. Do not subject the interposer assembly to more than five removal-reinstallation cycles, even if it appears unaffected.

### ◆ Assembly reflow soldering profile

Parameters	Pb-Free	Comment
Preheat Ramp Rate	2 - 3°C/sec	Other components may limit ramp rate to 2°C/sec
Soak Time	0 - 120 sec	Soak requirements determined by board design, oven capability, and paste activation requirements
Soak Temperature	160 - 215°C	Caution - "oversoaking" may exhaust flux and affect soldering
Peak Reflow Temperature	230 - 250°C	Cooler peak temperatures may require longer TAL's
Time Above Liquidus (TAL)	45 - 120 sec	Shorter TAL's may require higher peak temperatures
Cooling Rate	>6°C/sec	Faster cooling rates produce finer grain structures and smoother joint appearances
Maximum Package Body Temperature (T)	260°C	Open body design allows for low delta T between package and solder joint
Maximum Delta T between Body and PWB at Liquidus	10°C	Standard practice is easy to achieve with open body design
Package Body Exposure Limit at Maximum Temperature	5 sec	Adjust profile if maximum exposure limit is approached or exceeded

### Reflow Profile

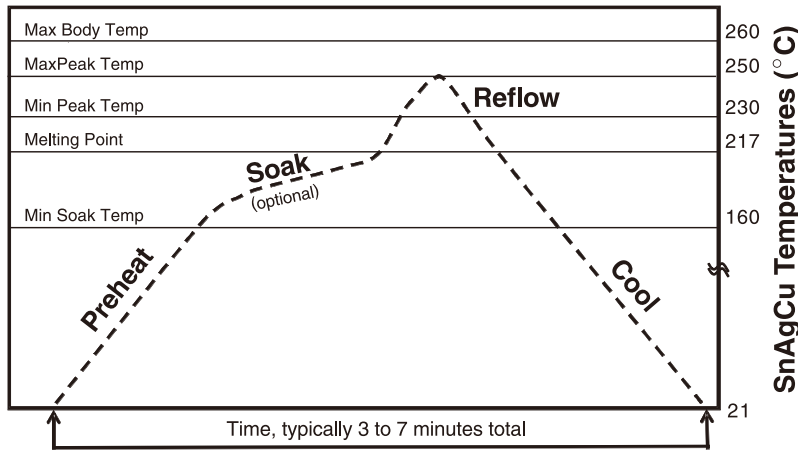

Different solder pastes have different thermal performance characteristics. Consult with paste manufacturer for optimum profile settings. Check thermal exposure limits of PWB laminate if processing with Pb-free solder.

### ◆ Mating self alignment

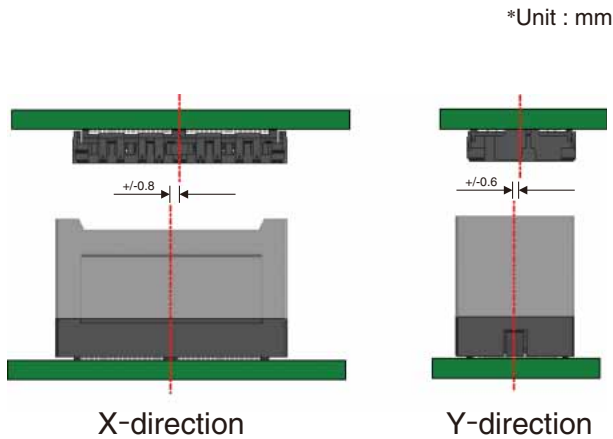

### ◆ Mating tolerance

Due to its 3-piece design, the IT3 connector system can accept mating tolerances of up to  $\pm 0.3$ mm tolerance in the X-axis and up to  $\pm 0.2$ mm in the Y-axis.

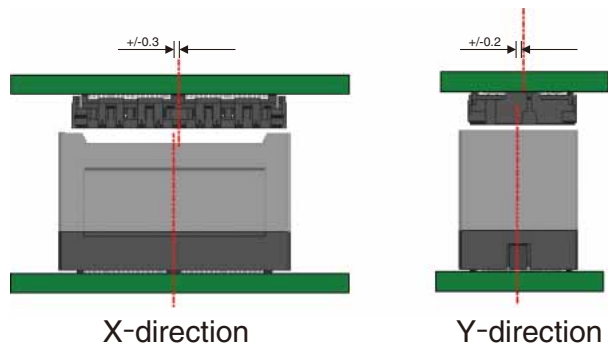

### ◆Packaging information

Please order per box with its Minimum Order Quantity (MOQ) of connectors contained. The number for each configuration is shown below.

●Receptacles

IT 3\* - \*\*\*S - BGA(\*\*)  
 (1) (2)

Unit : pcs

(1) \ (2)	100	200	300
M	120	72	48
D	120	72	48

This is also a packaging quantity, therefore please multiply integrally based on this MOQ quantity when you place more.

Ex.) 240pcs of IT3M-300S-BGA(37)  
 (= 5 of vacuum packed boxes)

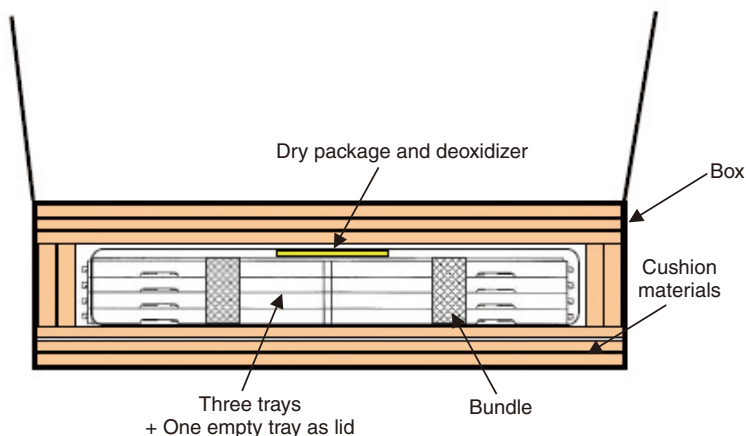

### ◆Packaging information

●Interposers

IT 3 - \*\*\*P - \*\*\*H(\*\*)  
 (3) (4)

Unit : pcs

(4) \ (3)	100	200	300
17	100	80	60
18	100	80	60
20	100	80	60
22	100	80	60
25	100	80	60
26	100	80	60
28	50	40	30
30	—	40	30
32	50	40	30
35	50	40	30
38	50	40	30
40	50	—	30

This is also a packaging quantity, therefore please multiply integrally based on this MOQ quantity when you place more.

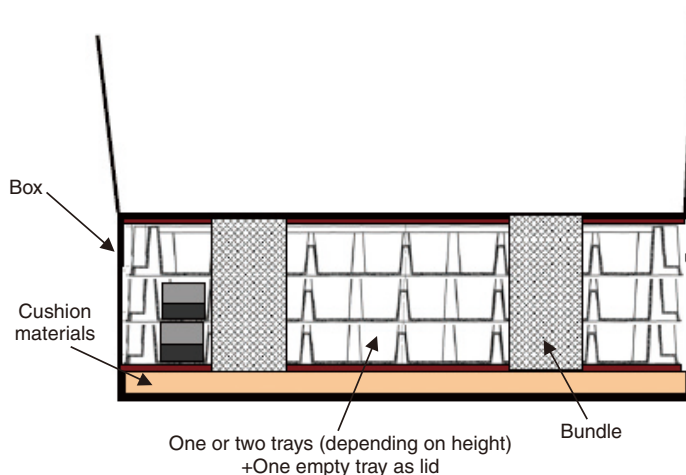

Mar.1.2026 Copyright 2026 HIROSE ELECTRIC CO., LTD. All Rights Reserved.

◆ Tray information

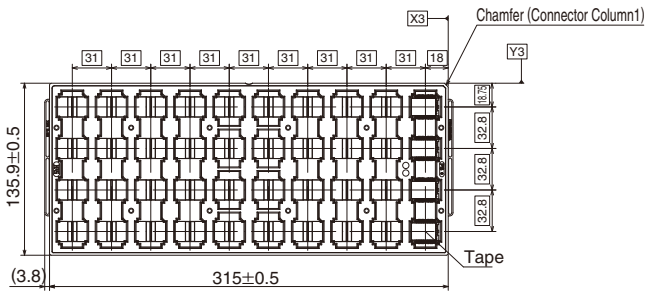

JEDEC Tray for IT3M 100 Position Receptacles and plug

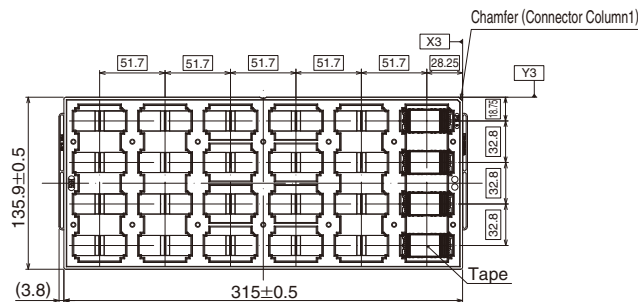

JEDEC Tray for IT3M 200 Position Receptacles and plug

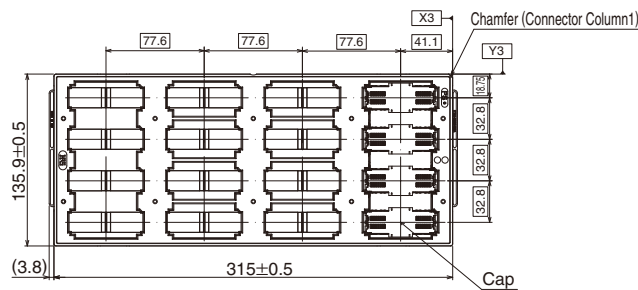

JEDEC Tray for IT3M 300 Position Receptacles and plug

◆ Tray information (con't)

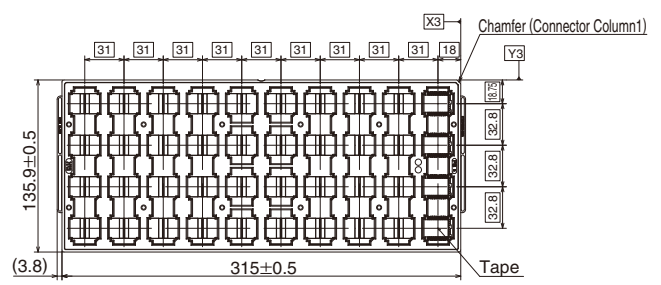

JEDEC Tray for IT3D 100 Position Receptacles

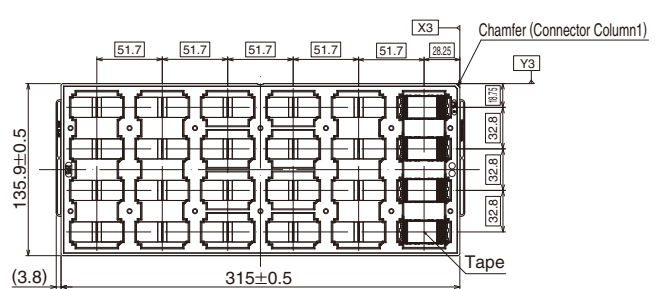

JEDEC Tray for IT3D 200 Position Receptacles

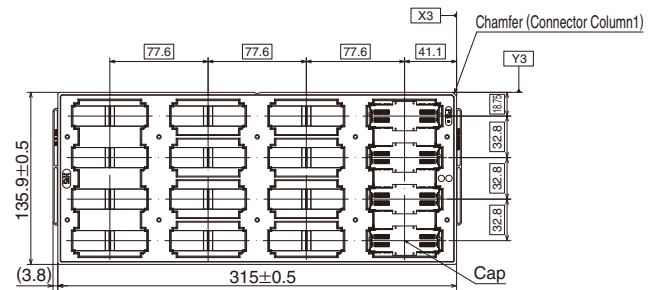

JEDEC Tray for IT3D 300 Position Receptacles

Mar.1.2026 Copyright 2026 HIROSE ELECTRIC CO., LTD. All Rights Reserved.



