

Mar.1.2026 Copyright 2026 HIROSE ELECTRIC CO., LTD. All Rights Reserved.
 In case of consideration for using Automotive equipment / device which demand high reliability, kindly contact our sales window correspondents.

The state applicable contact assembled

2
 Applicable contact(Selling separately)

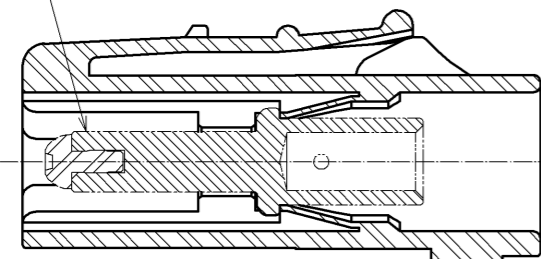

Mating mark

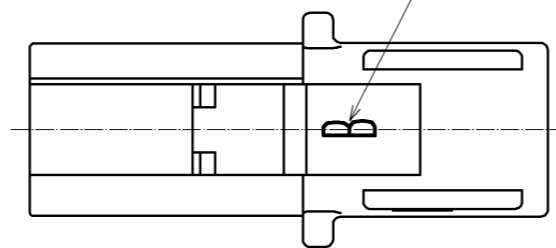

Notes ⚠ WARNING 1 This connector is not hot pluggable.
 2 Applicable crimp contacts:
 EV1-PC-112(02)(CL139-0004-9-02) or
 EV1-PC1-112(02)(CL139-0005-1-02)
 ⚠ WARNING 3 Make sure that the connector is inserted
 to the end and locked when mated.
 Confirm that the connector is not unintentionally released
 by pulling the cable with light force
 to prevent incomplete mating condition.

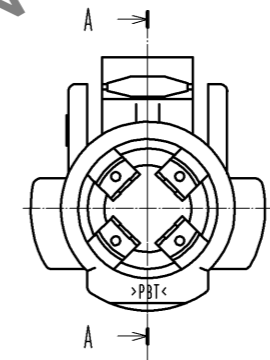
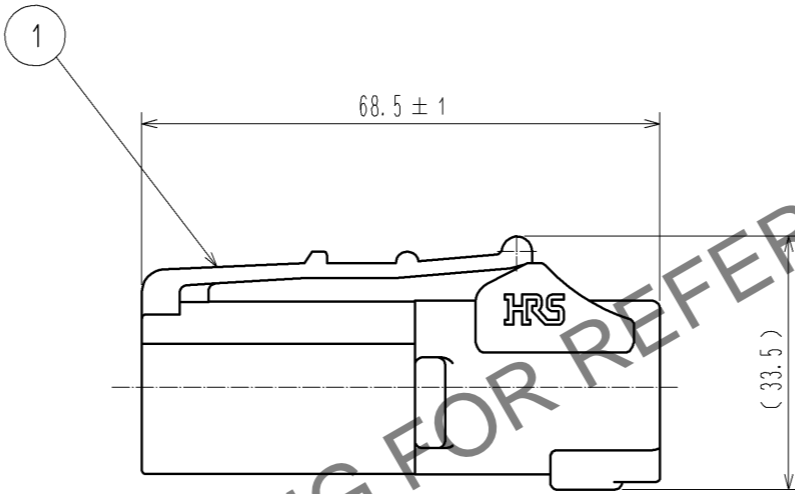
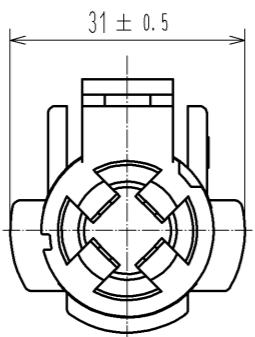

A-A

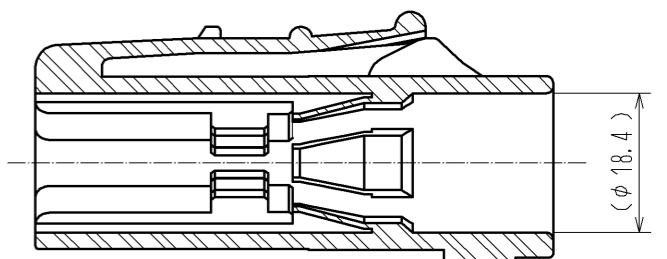

Dimension in mated condition (1:2)

When mated, the plug is to be
 at this indicated position.

M4 pan head machine screw
 (Commercial item)

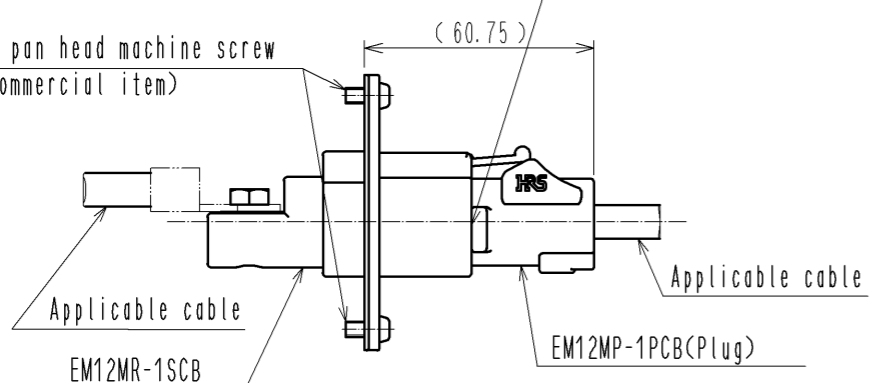

HRS DRAWING FOR REFERENCE

| 1 | PBT | UL94V-0 (Black) | | | | | |
|------------|----------|---------------------------|--------------------------|--------------------------|----------------------------|---------|------|
| NO. | MATERIAL | FINISH . REMARKS | NO. | MATERIAL | FINISH . REMARKS | | |
| UNITS | ⊕ | SCALE | △ | DESCRIPTION OF REVISIONS | DESIGNED | CHECKED | DATE |
| mm | | 1 : 1 | | | | | |
| HRS | | HIROSE ELECTRIC CO., LTD. | APPROVED : SU. OBARA | 14. 02. 04 | DRAWING NO. EDC3-118307-00 | | |
| | | | CHECKED : HY. KOBAYASHI | 14. 02. 04 | PART NO. EM12MP-1PCB | | |
| | | | DESIGNED : HS. KAWASHIMA | 14. 02. 04 | CODE NO. CL138-0033-0-00 | | |
| | | | DRAWN : HS. KAWASHIMA | 14. 02. 04 | 1/1 | | |