

<b>TITLE:</b>	BM28 Series Guideline	<b>ETAD-H1016-00</b>
<b>PRODUCT:</b>	HYBRID BOARD TO FPC CONNECTOR Pitch:0.35mm, Width:1.7mm Stacking height:0.6mm, Power:5A	PAGE: 1 OF 15

# BM28 Series Guideline

	Approver	WR.FUKUCHI	20210331
	Checker	TS.MIYAZAKI	20210330
	Designer	RH.KAGAMI	<b>20210330</b>
<b>REVISIONS</b>	DIS-H-00011614		RevNo   <b>1</b>
Designer	Checker	Approver	DATE
KH.ODA	TS.MIYAZAKI	WR.FUKUCHI	20211108

<b>TITLE:</b>	BM28 Series Guideline	<b>ETAD-H1016-00</b>
<b>PRODUCT:</b>	HYBRID BOARD TO FPC CONNECTOR Pitch:0.35mm, Width:1.7mm Stacking height:0.6mm, Power:5A	PAGE: 2 OF 15

**TABLE OF CONTENTS**

	<b>Page Number</b>
<b>1. Notice for Device Designing.....</b>	<b>3</b>
1.1 Notice for mechanical designing.....	3
1.1.1 Disengaging prevention.....	3
1.1.2 FPC fixing.....	4
1.1.3 Allocation of other components around connector.....	4
1.1.4 Marking for mating position.....	4
1.2 Notice for PWB designing.....	5
1.2.1 Recommended PWB layout.....	5
1.2.2 PWB pad layout and connector location.....	6
1.2.3 PWB designing.....	7
1.2.4 FPC designing.....	7
<b>2. Notice for mounting.....</b>	<b>8</b>
2.1 Metal mask design.....	8
2.2 Fillet forming.....	9
2.3 Reflow profile.....	10
2.4 Notice for repairing (hand soldering).....	11
<b>3. Notice for Connector Handling.....</b>	<b>12</b>
3.1 Connector insertion operation.....	12
3.2 Connector withdrawal operation.....	13
<b>4. PWB and Solder Paste for Evaluation Test.....</b>	<b>14</b>
4.1 PWB for evaluation test.....	14
4.2 Solder paste for evaluation.....	15

<b>TITLE:</b>	BM28 Series Guideline	<b>ETAD-H1016-00</b>
<b>PRODUCT:</b>	HYBRID BOARD TO FPC CONNECTOR Pitch:0.35mm, Width:1.7mm Stacking height:0.6mm, Power:5A	PAGE: 3 OF 15

# 1. Notice for Device Handling

## 1.1 Notice for mechanical designing

### 1.1.1 Disengaging prevention

There is still possibility that connectors are disengaged if strong impact, such as dropping, is put against connectors in use. In order to prevent connectors from disengaging, please make sure to put buffer material between a connector and a cover case to hold down the connector pair to the mating direction.  
(Please refer to Figure 1-1-1-a)

If a connector is directly pressed down by a cover case, there is a possibility that the cover case is bent and it may cause connector disengagement when the device is dropped. Please avoid a design that the connector is directly pressed by cover case, instead, use put the buffer material to press down the connector.  
Buffer material must be the size which is able to cover all over the connector mounting area.

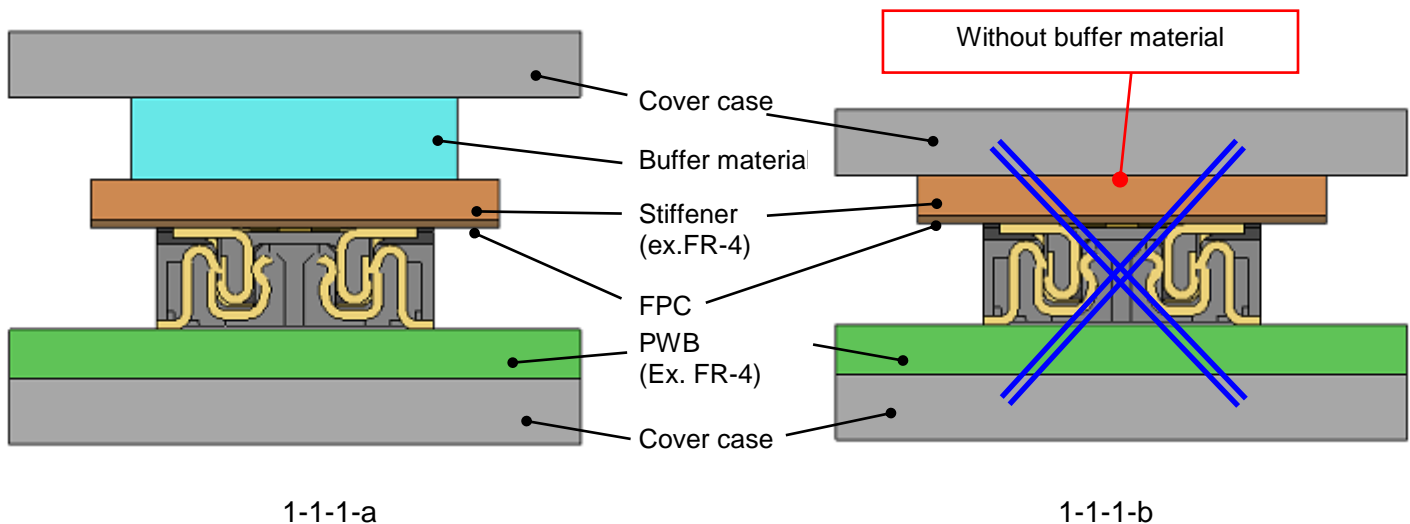

<b>TITLE:</b>	BM28 Series Guideline	<b>ETAD-H1016-00</b>
<b>PRODUCT:</b>	HYBRID BOARD TO FPC CONNECTOR Pitch:0.35mm, Width:1.7mm Stacking height:0.6mm, Power:5A	PAGE: 4 OF 15

**1.1.2 FPC fixing**

If FPC position is fixed, connector will get direct stress from dropping impact. Please do not design FPC positioning bosses which prevent flexibility of FPC. (Please refer to figure 1-1-2)

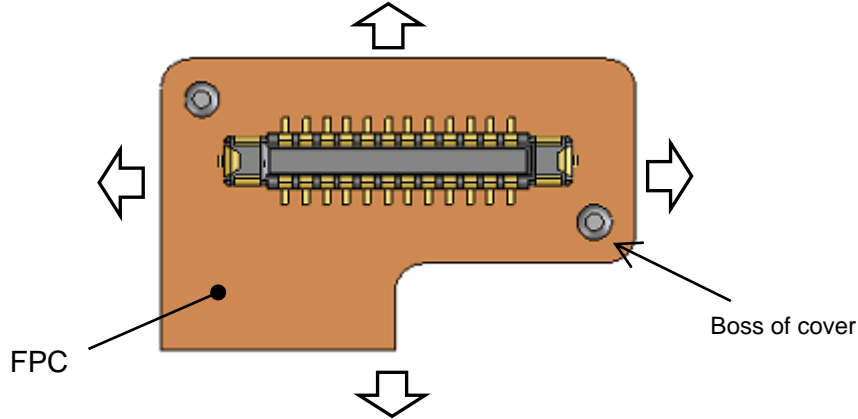

1-1-2: If FPC is fixed by boss of a cover case, there will be no flexibility for 4 dimension indicated by arrows.

**1.1.3 Allocation of other components around connector**

Please do not locate any material which may affect on connector mating around the connectors.

Please do not locate any material inside the red dashed.

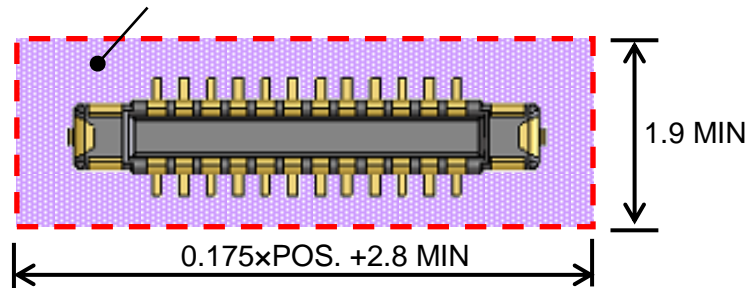

**1.1.4 Marking for mating position**

When mating a connector on the FPC side against the other side manually, in order to operate mating in the appropriate position without misalignment, please put some marking to indicate the exact mating position on the PWB.

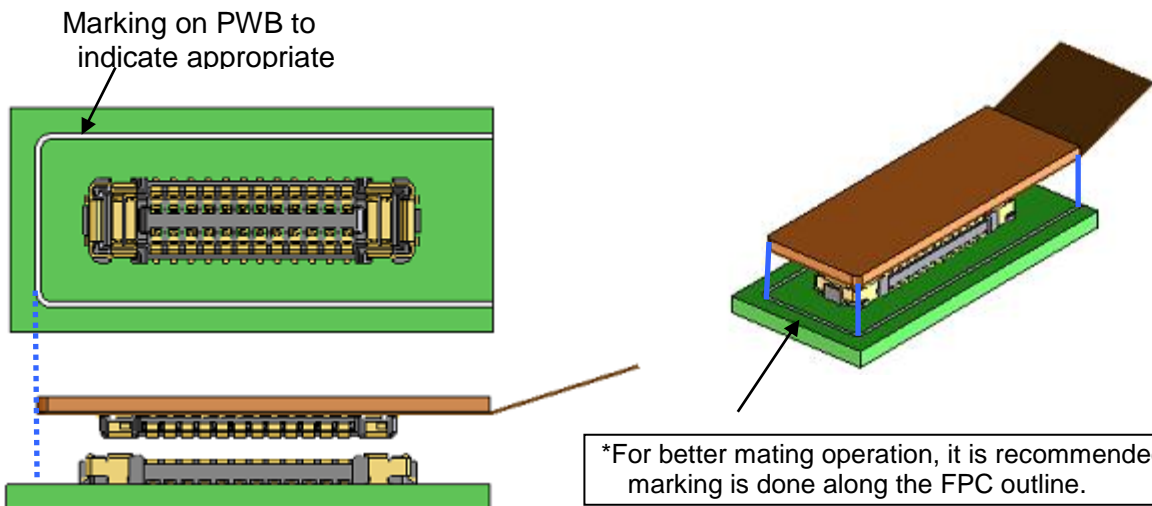

<b>TITLE:</b>	BM28 Series Guideline	<b>ETAD-H1016-00</b>
<b>PRODUCT:</b>	HYBRID BOARD TO FPC CONNECTOR Pitch:0.35mm, Width:1.7mm Stacking height:0.6mm, Power:5A	PAGE: 5 OF 15

## 1.2 Notice for PWB designing

### 1.2.1 Recommended PWB pattern (As an example)

Recommended PWB pattern for receptacle (Pos: pin count)

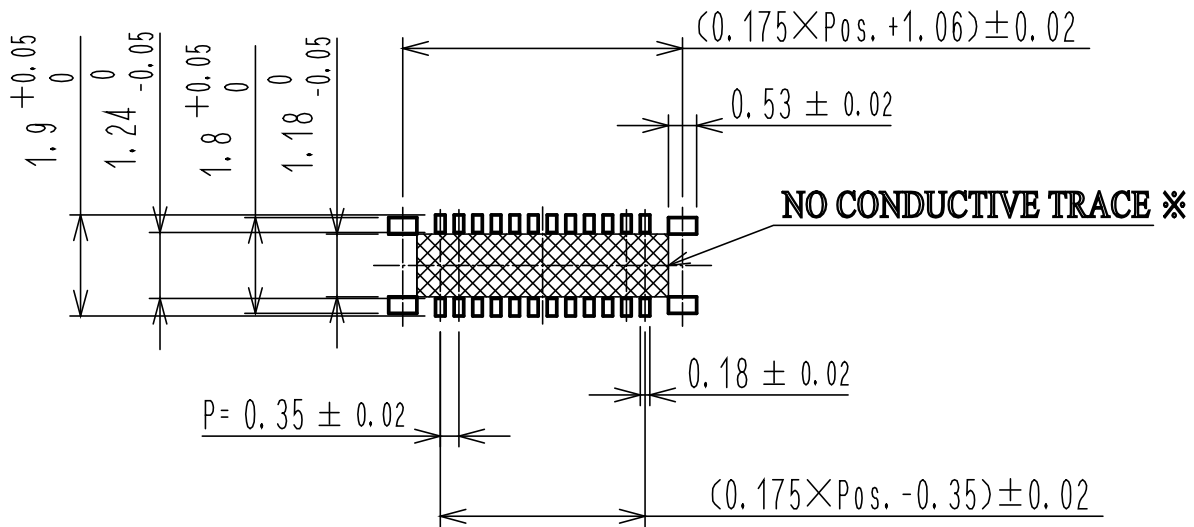

Recommended PWB pattern for plug (Pos: pin count)

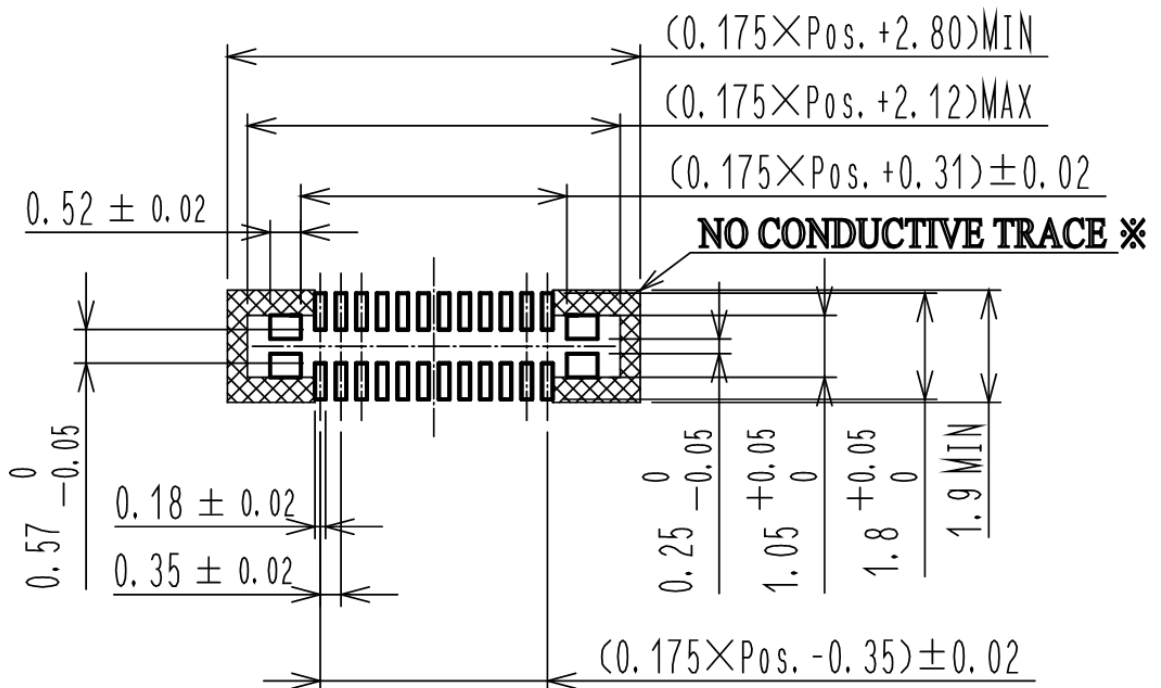

※ For the routing on the indicated PCB surface, apply solder resist in order for the insulation treatment.

<b>TITLE:</b>	BM28 Series Guideline	<b>ETAD-H1016-00</b>
<b>PRODUCT:</b>	HYBRID BOARD TO FPC CONNECTOR Pitch:0.35mm, Width:1.7mm Stacking height:0.6mm, Power:5A	PAGE: 6 OF 15

**1.2.2 PWB pad layout and connector location**

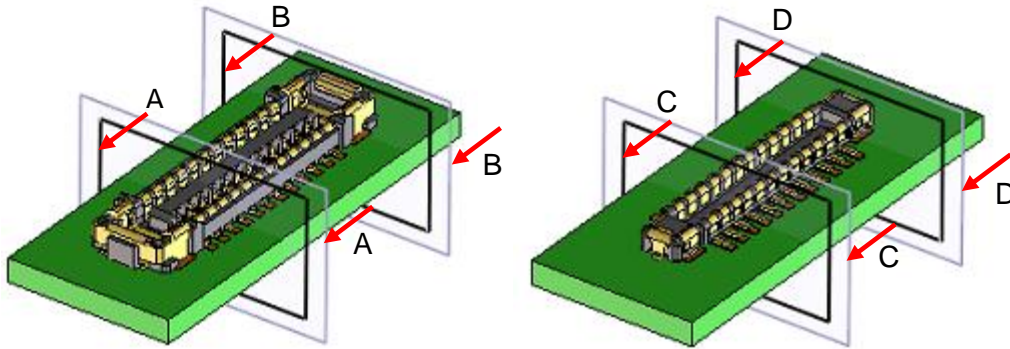

Pad layout and contact position for receptacle (A-A), A'

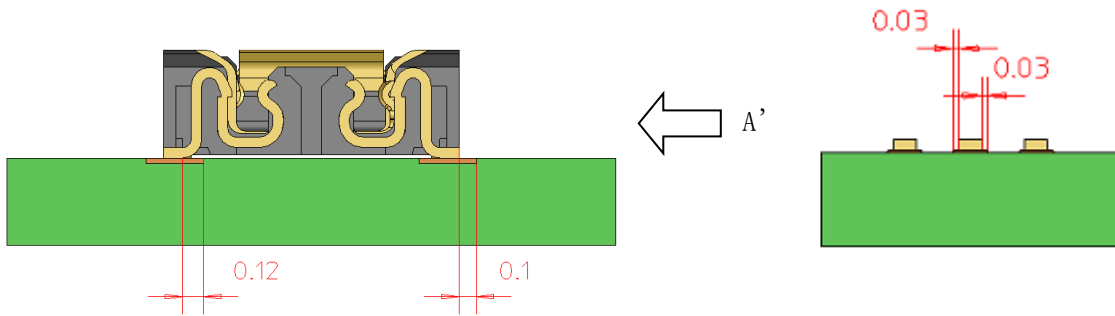

Pad layout and metal fitting position for Receptacle (B-B), B'

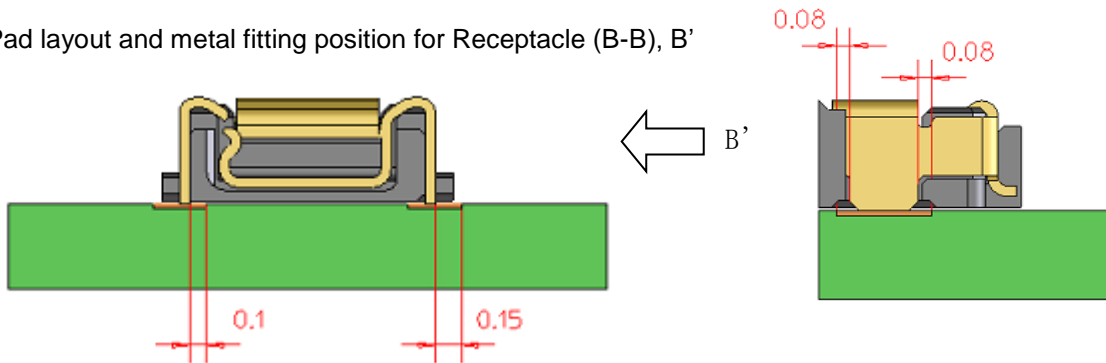

Pad layout and contact position for plug (C-C), C'

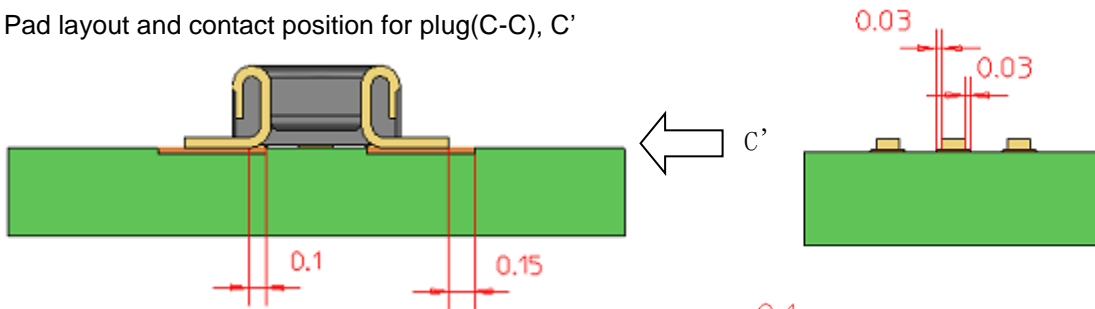

Pad layout and metal fitting position for plug (D-D), D'

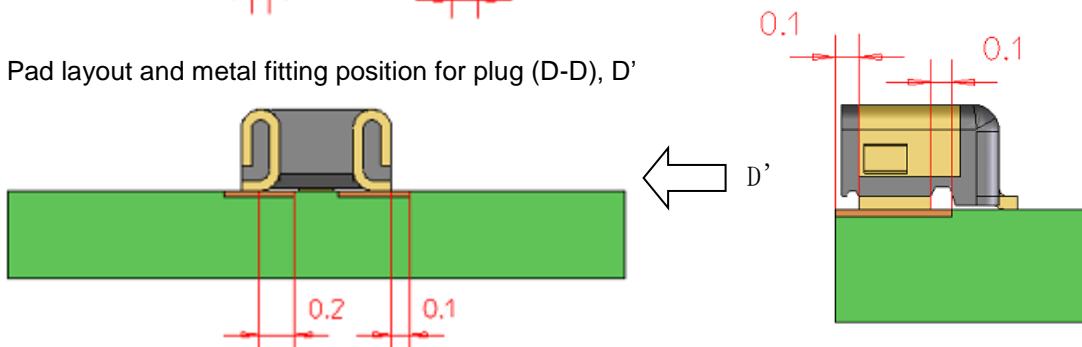

<b>TITLE:</b>	BM28 Series Guideline	<b>ETAD-H1016-00</b>
<b>PRODUCT:</b>	HYBRID BOARD TO FPC CONNECTOR Pitch:0.35mm, Width:1.7mm Stacking height:0.6mm, Power:5A	PAGE: 7 OF 15

### 1.2.3 PWB designing

- Please design PWB layout properly so that front fillet, back fillet and side fillet are formed. The recommended PWB layout is designed so that the connector can be soldered to the PWB appropriately.
- In case that the pad layout is narrower than our recommendation, If the pad layout is not wide enough, there is a possibility that solder wicking or flux splashing may occur. Please contact and discuss with us if the PWB layout is different from the recommended PWB layout.
- If there is not enough clearance on the inner side of PWB pattern, there is a possibility that the connector is pushed up by solder paste.
- In case those patterns are designed under a connector, there is a possibility to cause solder failure if there are physical height. Especially, in the following case, please conduct mounting test for the check.

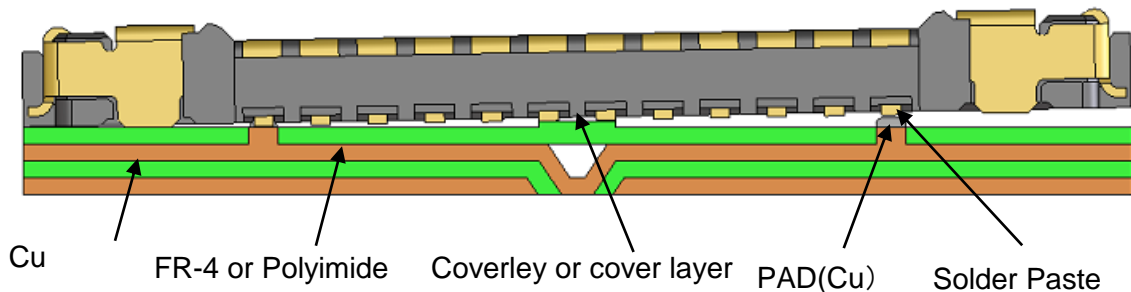

### 1.2.4 FPC designing

- FPC can be bent due to the diversity of coefficient thermal expansion of polyimide and copper foil. Please mount the connector in consideration of bending by heating.
- Please make sure to put a stiffener on the backside of the FPC. If polyimide is used as material, it is preferable to be as thick as possible. We recommend a glass epoxy material with the thickness of 0.3mm MIN, or a stainless material with the thickness of 0.2mm MIN.

Please consult HRS contact window when you use thinner stiffer than our recommendation. In addition, insertion feeling is tending to be hard when thinner stiffener is used.

TITLE:	BM28 Series Guideline	ETAD-H1016-00
PRODUCT:	HYBRID BOARD TO FPC CONNECTOR Pitch:0.35mm, Width:1.7mm Stacking height:0.6mm, Power:5A	PAGE: 8 OF 15

## 2. Notice for Mounting

### 2.1 Metal mask design

Recommended metal mask dimension for receptacle (Pos: pin count)

Recommended metal mask thickness: 0.08mm

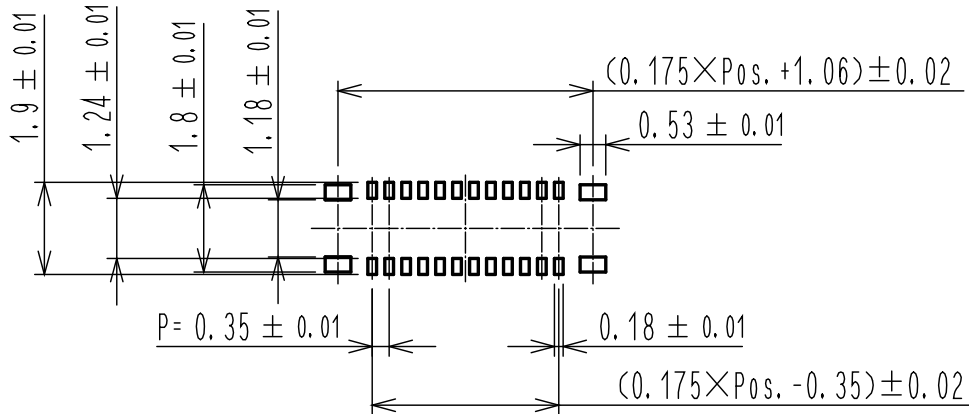

Open ratio of contacts area are 100%, and metal fittings area are 100% against the Recommended PWB pad layout (t=0.08mm).  
 Recommended soldering paste amount: Contact: 0.0048mm<sup>3</sup>, Metal fitting: 0.0131 mm<sup>3</sup>  
 Notice: If the soldering paste exceeds the recommended amount, there is a possibility of flux wicking.  
 If the soldering condition needs to be different from the recommended condition, please contact and discuss with us.

Recommended metal mask dimension for plug (POS: Pin count)

Recommended metal mask thickness: : 0.08mm

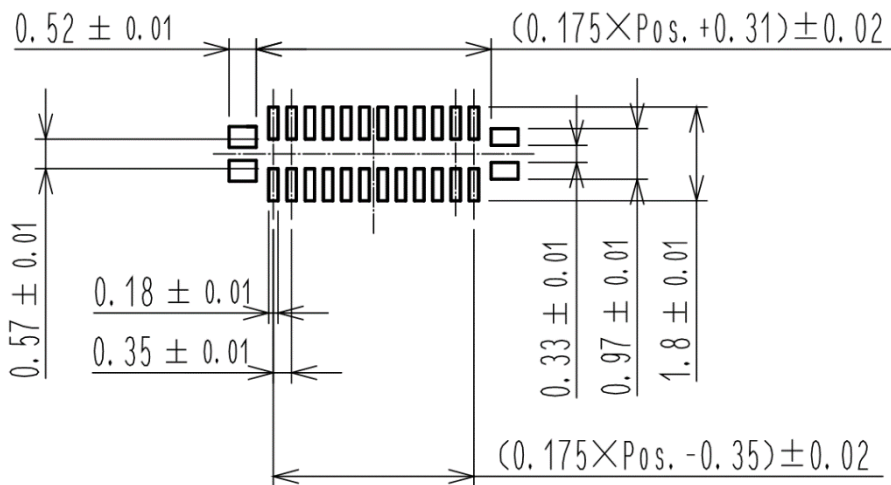

Both Open ratio of contacts area are 100%, and metal fitting area are 80% against the Recommended PWB pad layout (t=0.08mm).  
 Recommended soldering paste amount: Contact: 0.0089mm<sup>3</sup>, Metal fitting: 0.0133 mm<sup>3</sup>  
 Notice: If the soldering paste exceeds the recommended amount, there is a possibility of solder swelling.  
 If the soldering condition needs to be different from the recommended condition, please contact and discuss with us. Please refer to "Solder paste swelling" on page 11.



<b>TITLE:</b>	BM28 Series Guideline	<b>ETAD-H1016-00</b>
<b>PRODUCT:</b>	HYBRID BOARD TO FPC CONNECTOR Pitch:0.35mm, Width:1.7mm Stacking height:0.6mm, Power:5A	PAGE: 9 OF 15

## 2.2 Fillet forming

Fillet forming on receptacle

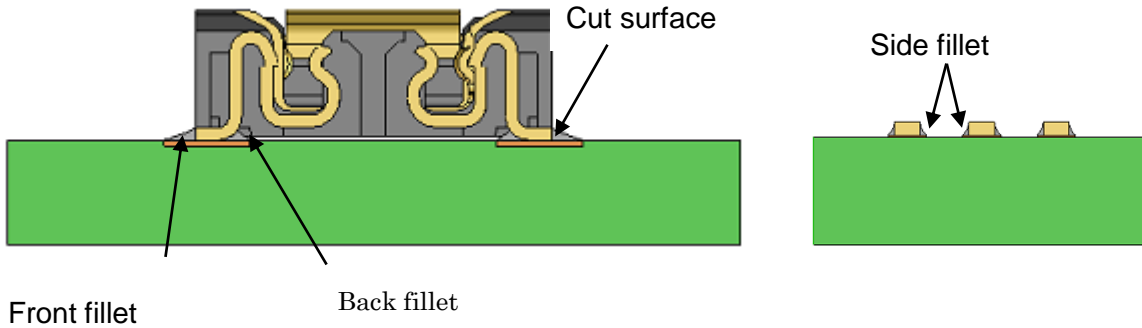

Fillet forming on plug

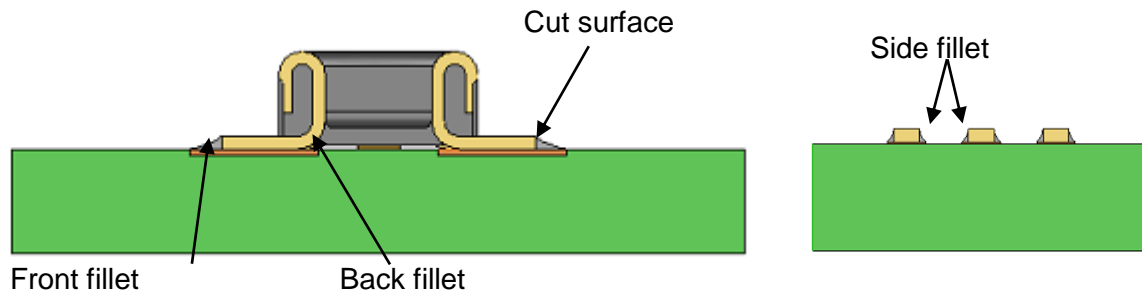

Likewise the other (receptacle) side, as the contact lead edge, on where "front fillet" is formed is a metal cut surface, phosphor bronze is exposed. The exposed area is easy to process thermal oxidation from reflow heating, so it is difficult for soldering paste to get wet and be spread over the area. If the fillet formation needs to be judged defective/not defective, please judge by "side fillet" forming.

<b>TITLE:</b>	BM28 Series Guideline	<b>ETAD-H1016-00</b>
<b>PRODUCT:</b>	HYBRID BOARD TO FPC CONNECTOR Pitch:0.35mm, Width:1.7mm Stacking height:0.6mm, Power:5A	PAGE: 10 OF 15

### 2.3 Reflow Profile

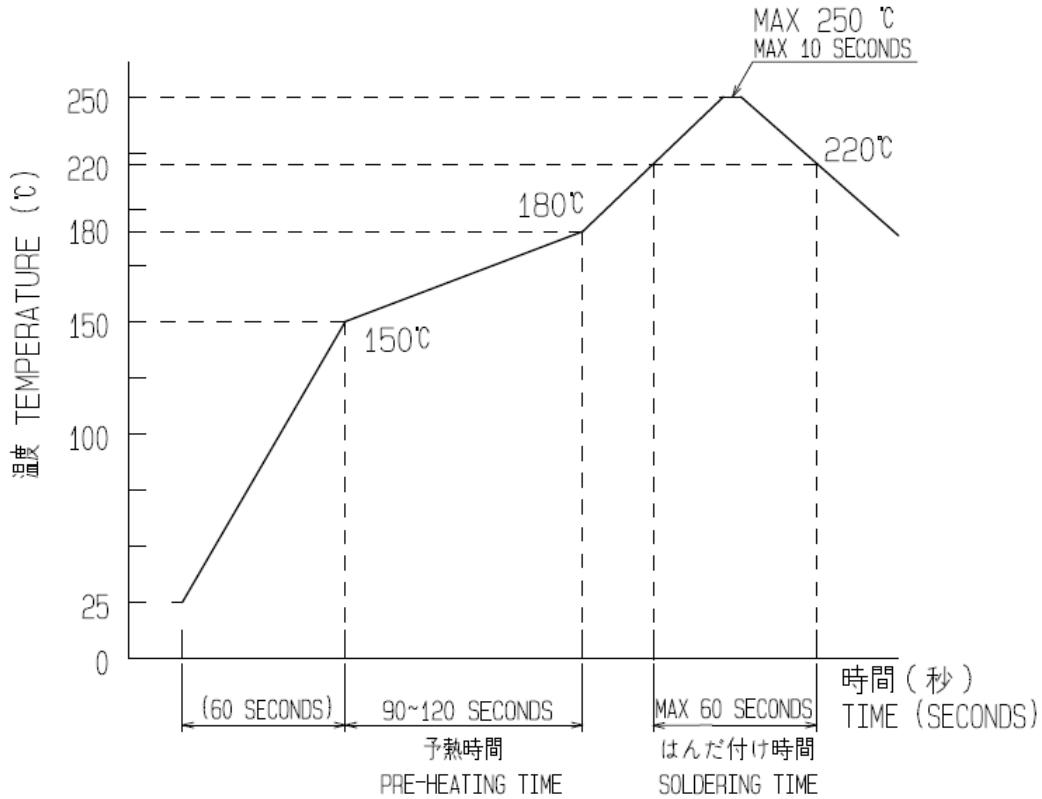

#### Profile measuring point

The temperature profile indicates the board surface temperature at the point of contacts with the connector terminals.

- Reflow cycles  
Up to 2 cycles of reflow soldering are possible under the same conditions.  
\*Temperature between 1st and 2nd reflow must be cooled down to room temperature.
- Reflow heating method and condition  
Far-infrared heater and hot convective blowers used in combination, normal atmosphere, or nitrogen atmosphere

#### Notifications for N<sub>2</sub> reflow

Please set O<sub>2</sub> concentration more than 1000[ppm] (HRS recommendation) in SMT  
Please feel free to contact us when it is less than 1000[ppm].

<b>TITLE:</b>	BM28 Series Guideline	<b>ETAD-H1016-00</b>
<b>PRODUCT:</b>	HYBRID BOARD TO FPC CONNECTOR Pitch:0.35mm, Width:1.7mm Stacking height:0.6mm, Power:5A	PAGE: 11 OF 15

## 2.4 Repairing (hand soldering)

### Receptacle

**Repairing Condition:**

- Soldering iron 350°C、3 seconds Max

**Notice :**

- Please do not put stress on contacts
- Please do not touch housing with a soldering iron

### Plug

**Repairing Condition :**

- Soldering iron 350°C、3 seconds Max

**Notice :**

- Please do not put stress on contacts
- Please do not touch housing with a soldering iron
- Please protect contact from flux or soldering paste splashing (ex. set a cover over the contact area.)

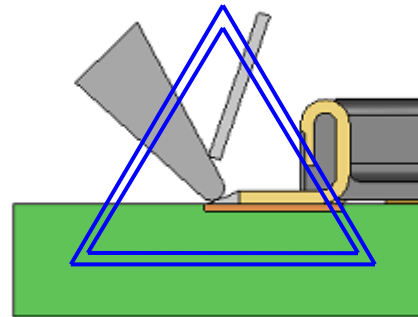
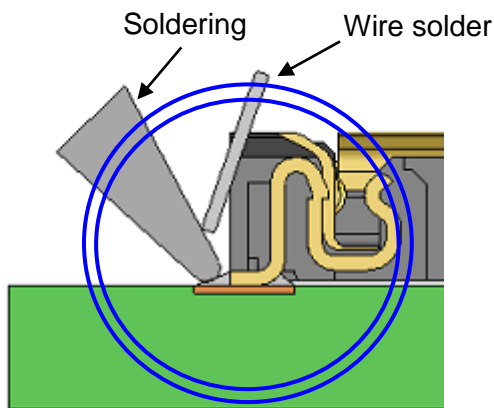

**Repairing process for metal fitting (Power contact)**

Receptacle: Please be careful to prevent solder or flux attaching to contact area (red color) of power contact.

Plug: Please be careful to prevent solder or flux attaching to contact area (red color) of power contact.

### Receptacle

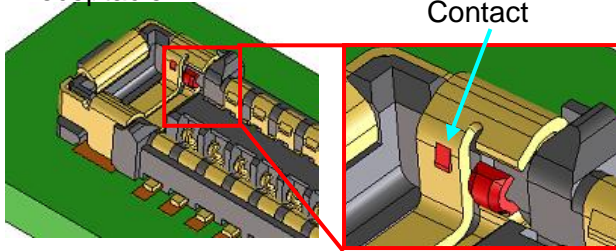

### Plug

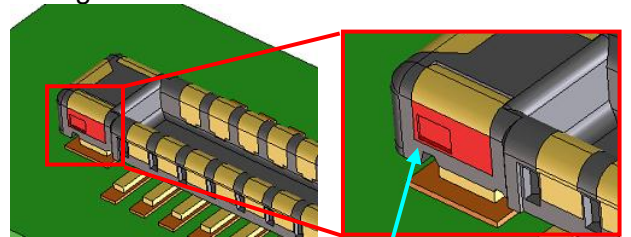

Contact area

### Soldering Paste Swelling

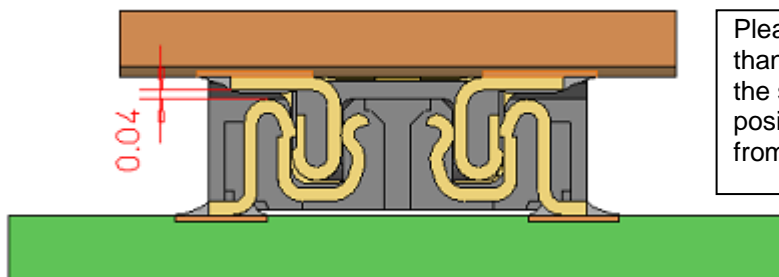

Please keep the soldering paste height less than 0.04mm in order to remove the risk that the soldering paste contacts the mating position due to the soldering paste height from plug lead.

If the soldering paste amount or wire solder amount for repairing are excessive, there will be soldering paste swelling on the contact lead area. The soldering paste swelling may affect on PWB stacking height or movement of spring contact of the other side.

TITLE:	BM28 Series Guideline	ETAD-H1016-00
PRODUCT:	HYBRID BOARD TO FPC CONNECTOR Pitch:0.35mm, Width:1.7mm Stacking height:0.6mm, Power:5A	PAGE: 12 OF 15

### 3. Notice for Connector Handling

#### 3.1 Connector insertion operation

Please mate this connector by hands.

Manual for inserting operation

- 1) Find the alignment area with hand to locate the connector in the appropriate mating position. This connector has alignment chamber (guidance ribs) on receptacle side and R on plug side, so that the connector can be self-aligned.

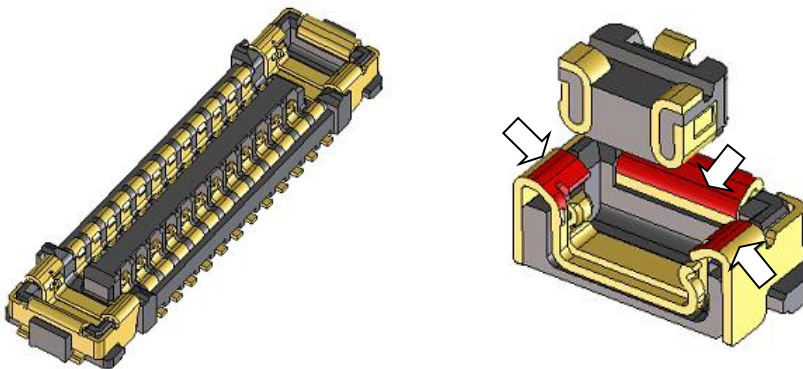

- 2) When the connector comes to the appropriate position, the connector comes into the aligned position. If the connector comes into aligned position. It can be recognized by hand that the connector goes down.

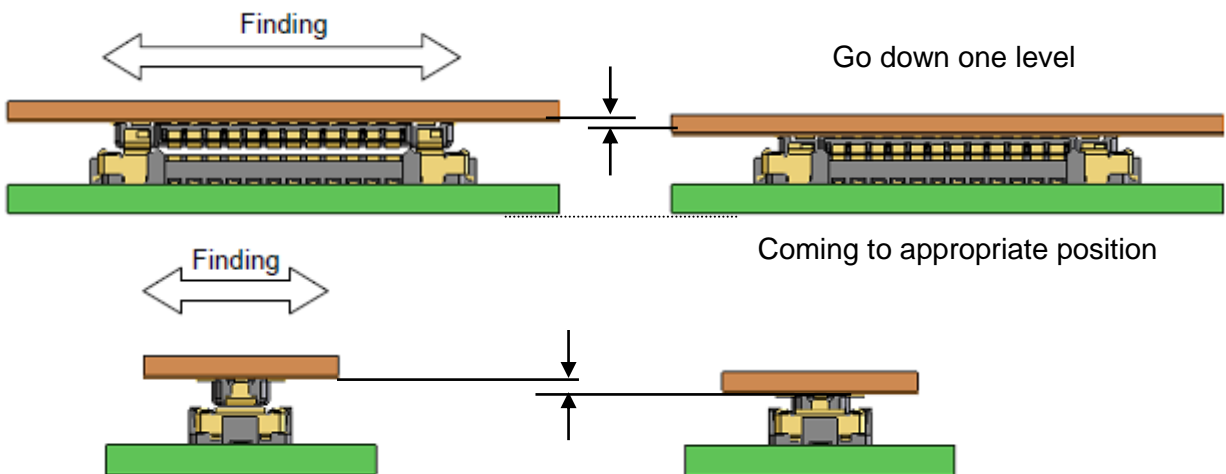

- 3) When the connectors are in alignment position, the connector pair cannot be moved back and forth and around as they are mated in a parallel position. Please mate the connectors completely, by putting force in this condition.



- 4) Please make sure connectors are mated completely. If one side is floating or the connectors are mated at a slant, please unmate once, and then mate them once again, following the procedures above from the beginning.

<b>TITLE:</b>	BM28 Series Guideline	<b>ETAD-H1016-00</b>
<b>PRODUCT:</b>	HYBRID BOARD TO FPC CONNECTOR Pitch:0.35mm, Width:1.7mm Stacking height:0.6mm, Power:5A	PAGE: 13 OF 15

### 3.2 Connector withdrawal operation

- 1) It is desirable to withdraw the connector in the vertical direction against mating direction. However, in the case connector has high pin counts or thinner FPC and stiffener, it makes more difficult to withdraw the connector in the vertical direction.

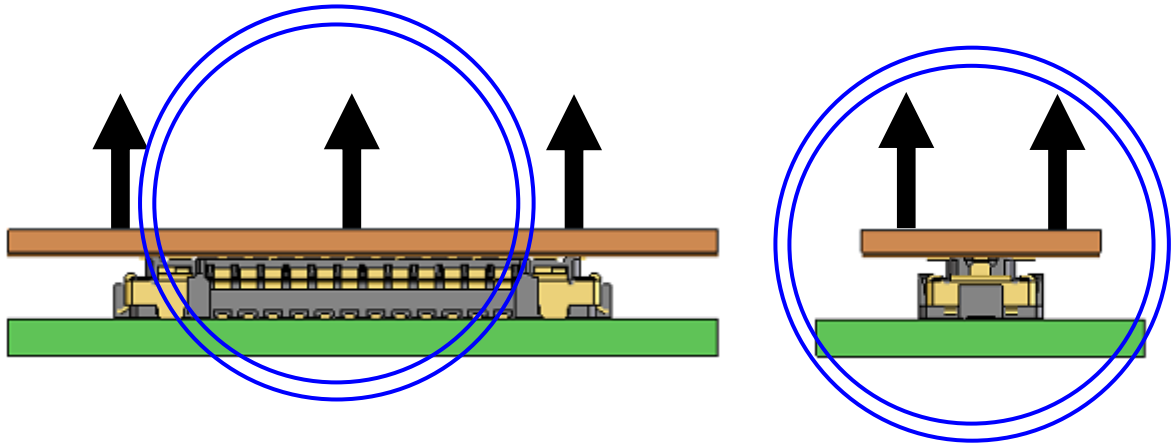

- 2) If it is difficult to withdraw the connector, please withdraw the connector diagonally against the contact pitch direction. Please carefully withdraw the connector from the width side as a strong load is put on the plug.

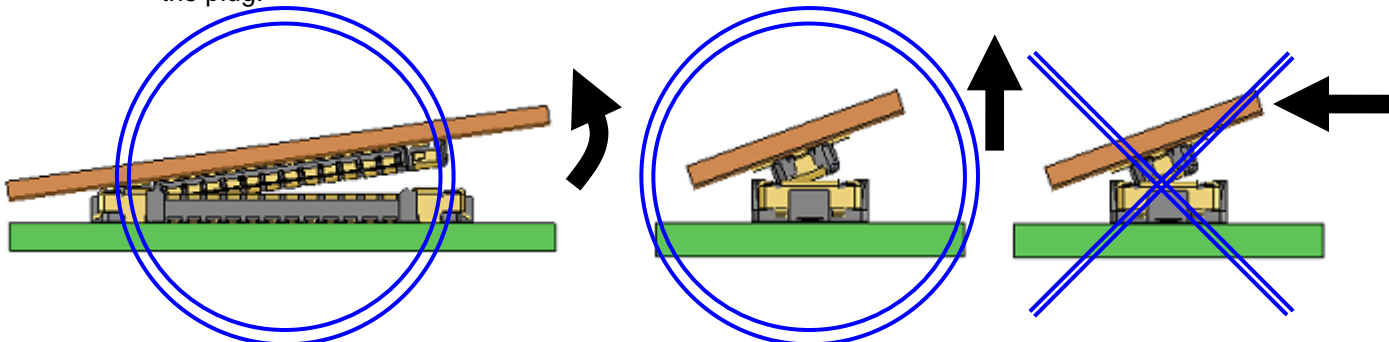

- 3) If the FPC is not strong enough, there is a possibility that contacts may be pulled off or broken. Please make sure to conduct the test on FPC to repeat operation several times in an early stage build. Please carefully withdraw the connector in the slanted direction, picking the FPC corner, as it can be a risk to put a strong load on contacts.

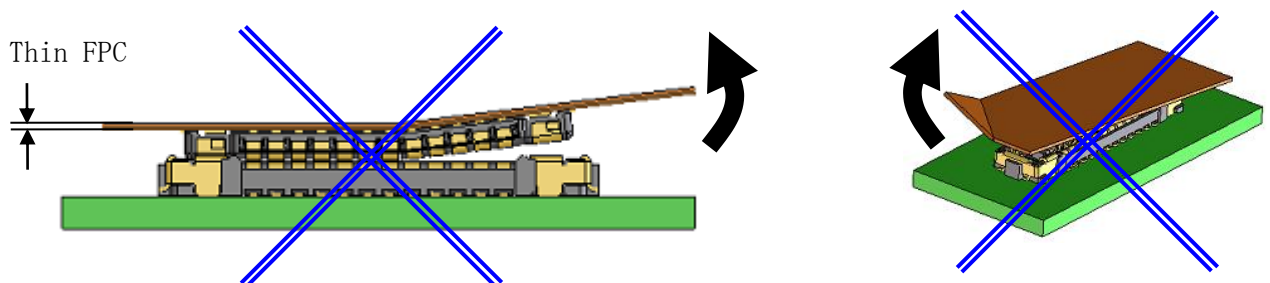

<b>TITLE:</b>	BM28 Series Guideline	<b>ETAD-H1016-00</b>
<b>PRODUCT:</b>	HYBRID BOARD TO FPC CONNECTOR Pitch:0.35mm, Width:1.7mm Stacking height:0.6mm, Power:5A	PAGE: 14 OF 15

## 4. PWB and Solder Paste for Evaluation Test

### 4.1 PWB for evaluation test

FR-4 PWB for Receptacle

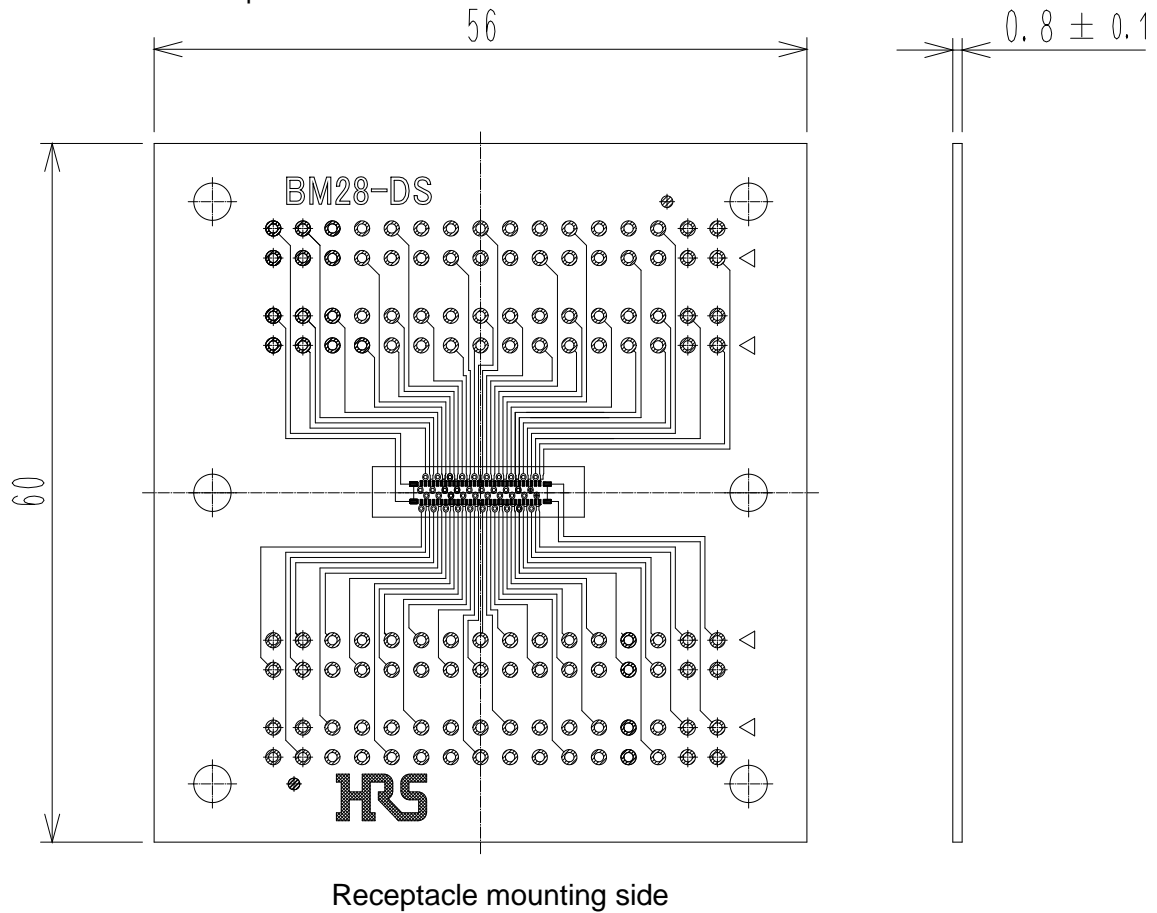

<b>TITLE:</b>	BM28 Series Guideline	<b>ETAD-H1016-00</b>
<b>PRODUCT:</b>	HYBRID BOARD TO FPC CONNECTOR Pitch:0.35mm, Width:1.7mm Stacking height:0.6mm, Power:5A	PAGE: 15 OF 15

FPC for Plug

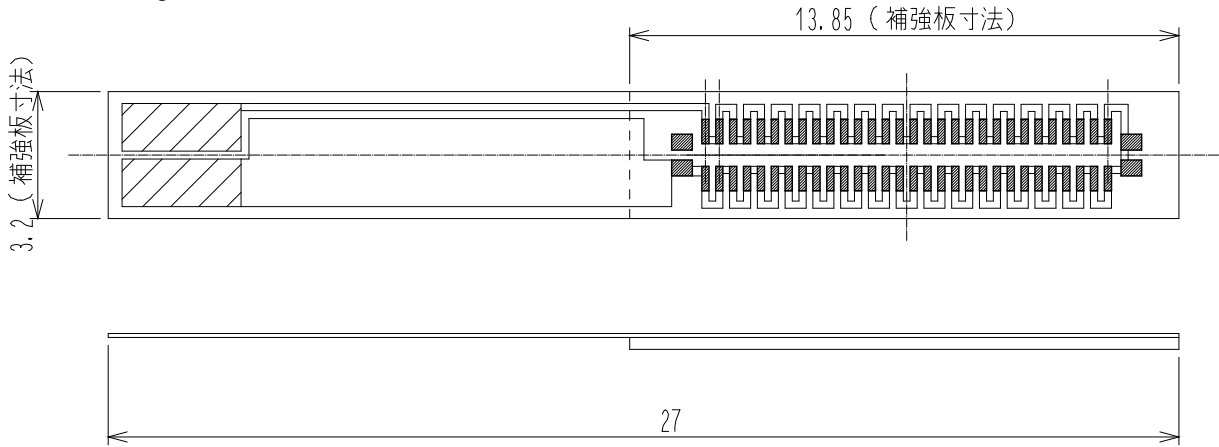

FPC material configuration

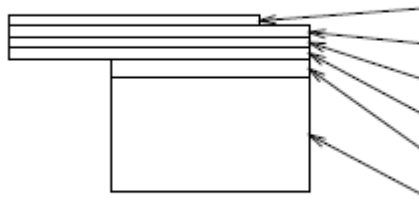

Layer	Material	Thickness (um)
Resist	Inc	15
Cu		35
Base adhesive		20
Base film	Polyimide	25
Stiffener adhesive	Adhesive	30~40
Stiffener	FR-4	300
	Total	425~435

\* In the case of stainless: 200um

## 4.2 Solder paste for evaluation test

Lead-free Solder Paste

End of report