

Aug.1.2021 Copyright 2021 HIROSE ELECTRIC CO., LTD. All Rights Reserved.  
In case of consideration for using Automotive equipment / device which demand high reliability, kindly contact our sales window correspondents.

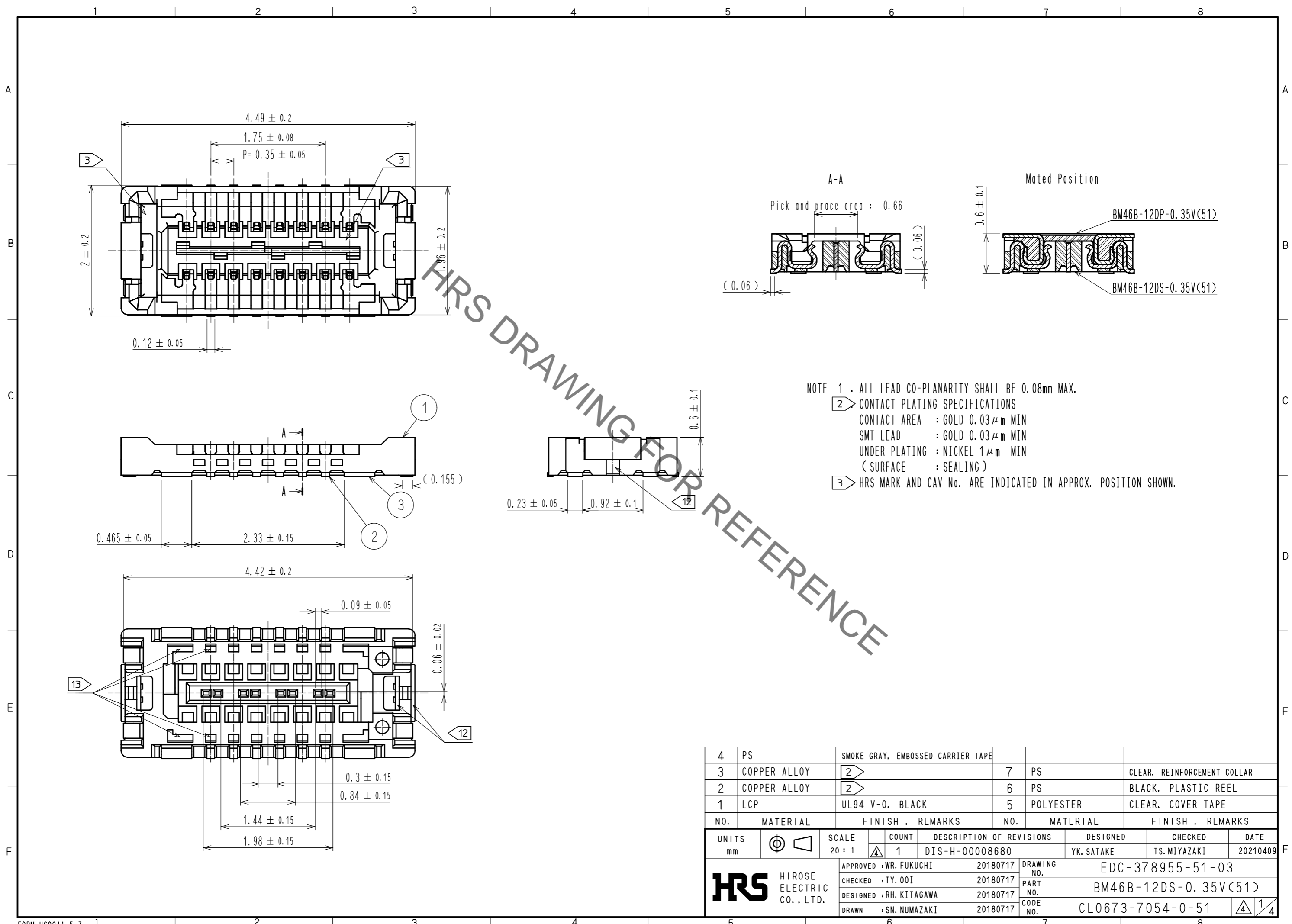

HRS DRAWING FOR REFERENCE

NOTE 1 . ALL LEAD CO-PLANARITY SHALL BE 0.08mm MAX.

- 2 CONTACT PLATING SPECIFICATIONS  
CONTACT AREA : GOLD  $0.03 \mu\text{m}$  MIN  
SMT LEAD : GOLD  $0.03 \mu\text{m}$  MIN  
UNDER PLATING : NICKEL  $1 \mu\text{m}$  MIN  
( SURFACE : SEALING )
- 3 HRS MARK AND CAV No. ARE INDICATED IN APPROX. POSITION SHOWN.

4	PS	SMOKE GRAY, EMBOSSED CARRIER TAPE					
3	COPPER ALLOY	2	7	PS	CLEAR, REINFORCEMENT COLLAR		
2	COPPER ALLOY	2	6	PS	BLACK, PLASTIC REEL		
1	LCP	UL94 V-0, BLACK	5	POLYESTER	CLEAR, COVER TAPE		
NO.	MATERIAL	FINISH . REMARKS	NO.	MATERIAL	FINISH . REMARKS		
UNITS mm		SCALE 20 : 1	COUNT 1	DESCRIPTION OF REVISIONS DIS-H-00008680	DESIGNED YK. SATAKE	CHECKED TS. MIYAZAKI	DATE 20210409
<b>HRS</b> HIROSE ELECTRIC CO., LTD.		APPROVED : WR. FUKUCHI	20180717	DRAWING NO. EDC-378955-51-03			
		CHECKED : TY. OOI	20180717	PART NO. BM46B-12DS-0.35V(51)			
		DESIGNED : RH. KITAGAWA	20180717	CODE NO. CL0673-7054-0-51			
		DRAWN : SN. NUMAZAKI	20180717	1/4			

Aug.1.2021 Copyright 2021 HIROSE ELECTRIC CO., LTD. All Rights Reserved.  
 In case of consideration for using Automotive equipment / device which demand high reliability, kindly contact our sales window correspondents.

RECOMMENDED PCB LAYOUT (10:1)

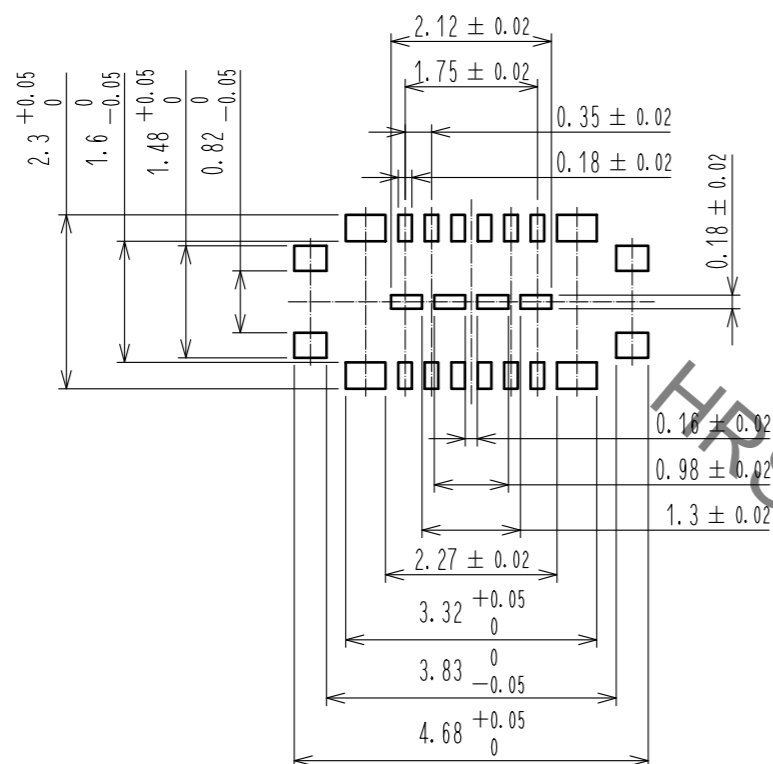

RECOMMENDED METAL MASK DIMENSIONS (10:1)  
 METAL MASK THICKNESS :  $80 \mu\text{m}$

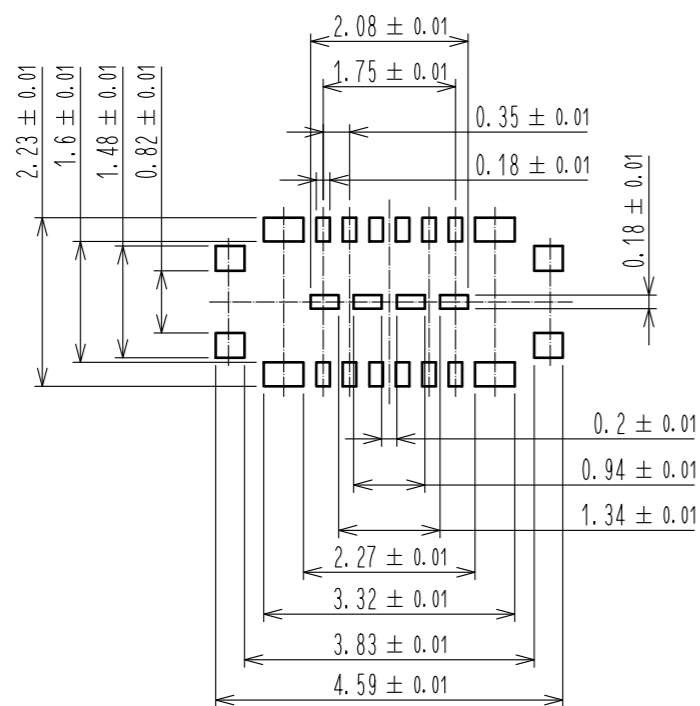

4 RECOMMENDED REFLOW TEMPERATURE PROFILE USING LEAD-FREE SOLDER PASTE.

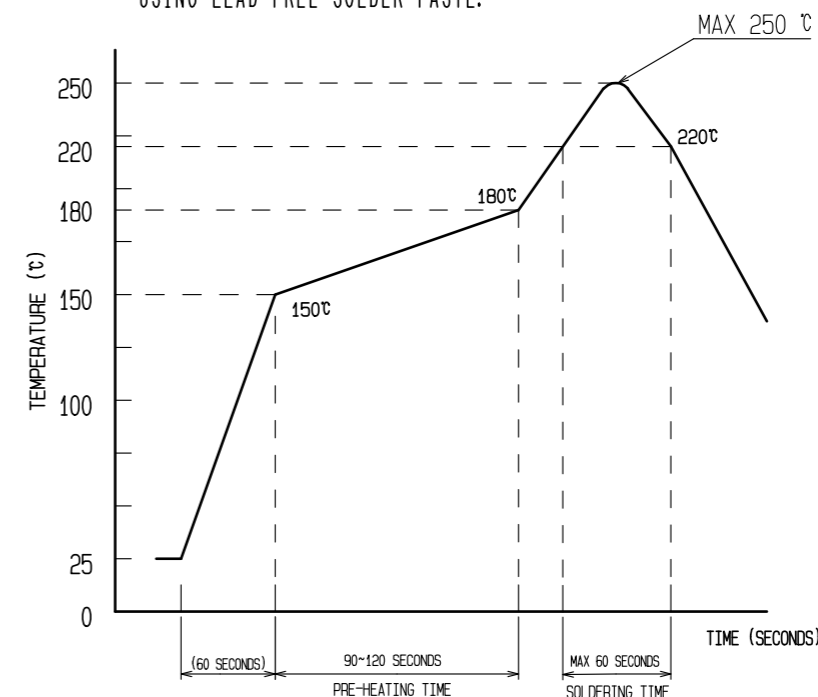

REFLOW METHOD: IR REFLOW  
 NUMBER OF REFLOW CYCLES: 2 CYCLES MAX.  
 1) REFLOW TIME  
 DURATION ABOVE 220°C, 60 SEC MAX.  
 (PEAK TEMPERATURE: 250°C MAX)  
 2) PRE-HEAT TIME  
 PRE-HEAT TEMPERATURE (MIN): 150°C  
 PRE-HEAT TEMPERATURE (MAX): 180°C  
 PRE-HEAT TIME: 90-120 SEC.

- 4 THIS TEMPERATURE PROFILE IS PER THE CONDITIONS SHOWN ABOVE. ADDITIONAL FACTORS, SUCH AS SOLDER PASTE TYPE, PCB SIZE AND OTHER MOUNTED COMPONENTS COULD AFFECT THE PROFILE, THEREFORE, A THOROUGH EVALUATION OF MOUNTING CONDITION IS REQUIRED PRIOR TO PRODUCTION. TEMPERATURE IS MEASURED AT CONTACT LEAD.
5. PLEASE CONTACT US IN CASE YOU WILL MAKE DIFFERENT SETTINGS FROM OUR RECOMMENDATION.
  6. THIS PRODUCT SATISFIES HALOGEN FREE REQUIREMENTS DEFINED AS 900ppm MAXIMUM CHLORINE, 900ppm MAXIMUM BROMINE, AND 1500ppm MAXIMUM TOTAL OF CHLORINE AND BROMINE.
  7. THIS PRODUCT COMPLY WITH RoHS.

<b>HRS</b>	DRAWING NO.	EDC-378955-51-03
	PART NO.	BM46B-12DS-0.35V(51)
	CODE NO.	CL0673-7054-0-51

Aug.1.2021 Copyright 2021 HIROSE ELECTRIC CO., LTD. All Rights Reserved.  
In case of consideration for using Automotive equipment / device which demand high reliability, kindly contact our sales window correspondents.

# EMBOSED CARRIER TAPE PACKAGING (5:1)

# STYLE AND DIMENSION OF REEL (FREE)

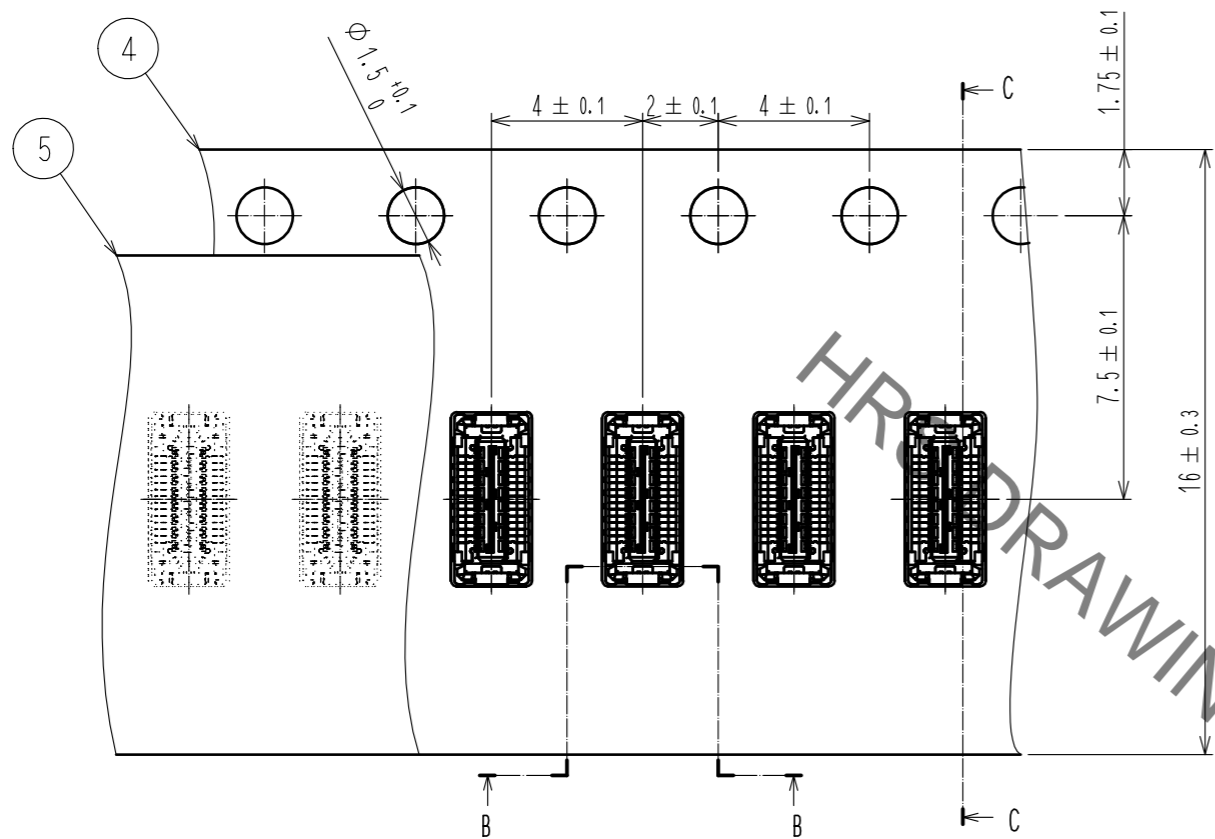

## C-C (5:1)

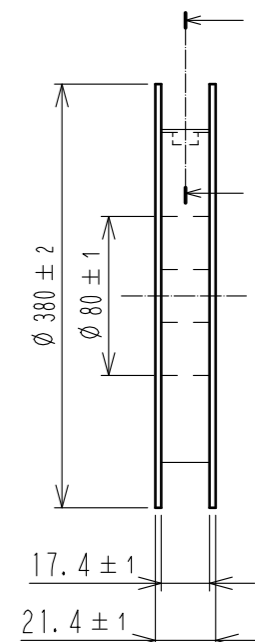
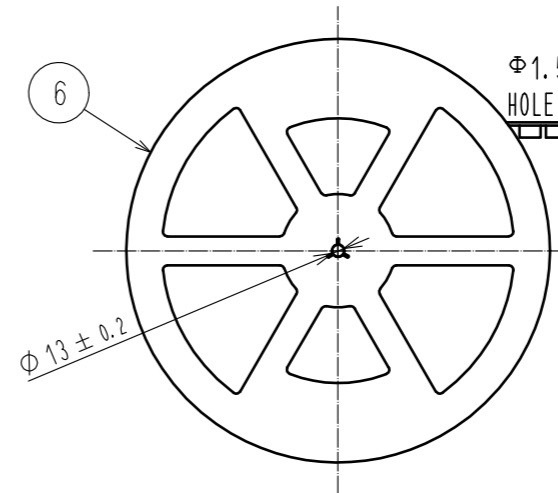
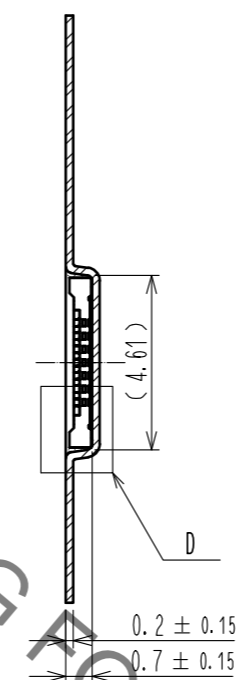

## E-E (FREE)

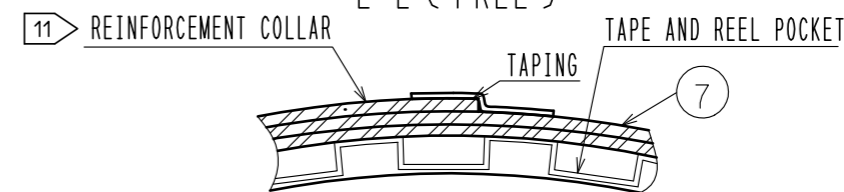

## B-B (5:1)

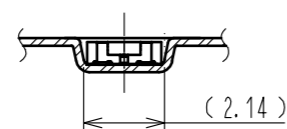

DIRECTION OF UNREELING

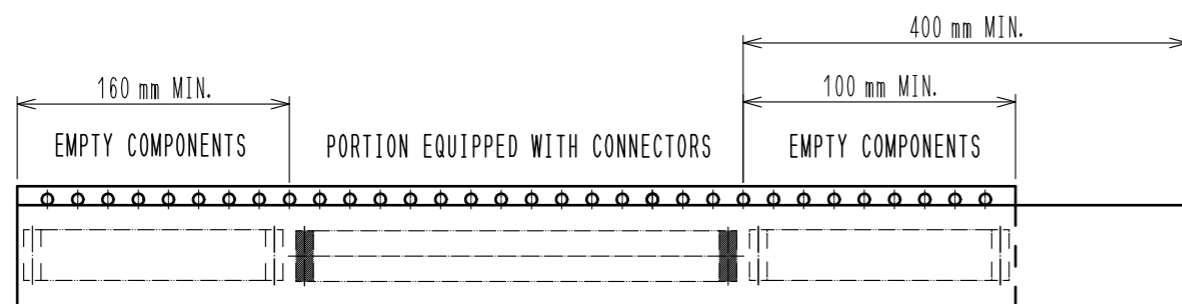
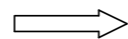

## D (10:1)

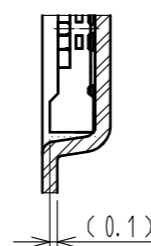

- 8 . PER REEL 20,000 CONNECTORS.
- 9 . THE DIMENSIONS IN PARENTHESES ARE FOR REFERENCE.
- 10 REFER TO IEC 60286-3 (PACKAGING OF COMPONENTS FOR AUTOMATIC HANDLING)
- 11 AFTER PACKAGING, ROLL 2 METERS OF THE REINFORCEMENT COLLAR TO OUTER CIRCUMFERENCE OF TAPE AND REEL POCKET, AND TAPE DOWN AT THE END THE COLLAR.
- 12 METAL OR RESIN IS ACCEPTABLE FOR THIS AREA.
- 13 NO GOLD PLATING IS ACCEPTABLE FOR THIS AREA.

TRAILER

10 TAPING(FREE)

LEADER

**HRS**

DRAWING NO.	EDC-378955-51-03
PART NO.	BM46B-12DS-0.35V(51)
CODE NO.	CL0673-7054-0-51

3/4

Aug.1.2021 Copyright 2021 HIROSE ELECTRIC CO., LTD. All Rights Reserved.  
In case of consideration for using Automotive equipment / device which demand high reliability, kindly contact our sales window correspondents.

14. PLEASE REFER TO THE PRODUCT GUIDELINE ETAD-H1012 FOR DETAIL OF CONNECTOR HANDLING.

THE POSITION BETWEEN THE CONNECTOR AND PAD

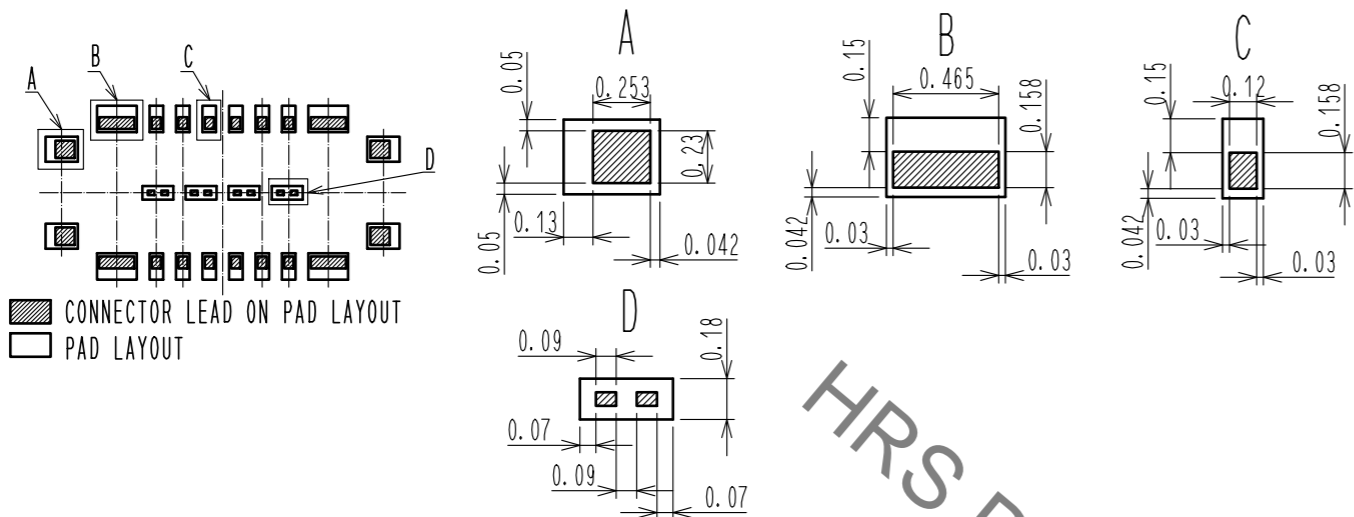

CAUTION FOR SOLDERING

THERE IS METAL EXPOSURE AREA BOTTOM OF THE CONNECTOR.  
TO AVOID SOLDER WICKING FROM THE BOTTOM SIDE, PLEASE DESIGN PCB PAD AND STENCIL WITH RECOMMENDED DIMENSIONS.

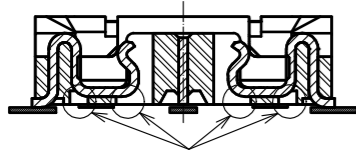

MATING METHOD

PLEASE MATE THE CONNECTOR BY HAND.

MATING PROCEDURE

- (1) FIND THE ALIGNMENT AREA TO THE CONNECTOR IN THE APPROPRIATE MATING POSITION.  
THIS CONNECTOR HAS AN ALIGNMENT CHAMBER(GUIDANCE RIBS) ON RECEPTACLE SIDE AND 'R' ON PLUG SIDE, SO THAT THE CONNECTOR WILL BE SELF-ALIGNED.  
WHEN THE CONNECTOR COMES TO THE APPROPRIATE POSITION, THE CONNECTOR GOES INTO THE ALIGNED POSITION.  
WHEN ALIGNED, IT CAN BE FELT BY HAND.

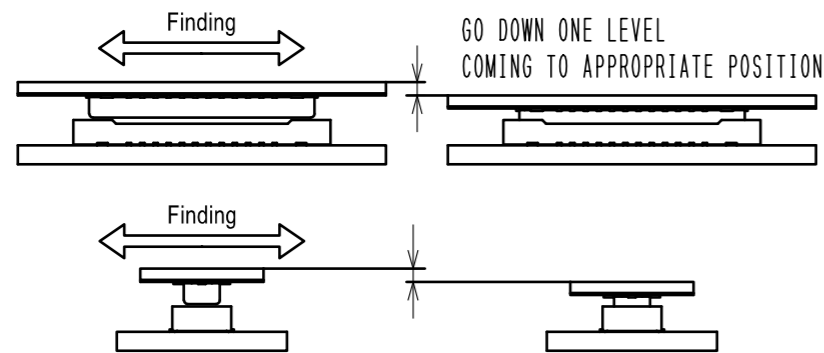

- (2) WHEN GUIDING, THE CONNECTORS ARE ALIGNED PARALLEL TO EACH OTHER, WITH LONGITUDINAL AND LATERAL MOVEMENTS RESTRICTED. MATE THEM PROPERLY BY APPLYING FORCE IN THIS CONDITION.



- (3) MAKE SURE THE CONNECTORS ARE MATED CORRECTLY. IF ONE SIDE IS FLOATING OR THE CONNECTORS ARE MATED IN ONE DIRECTION, UN-MATE THEM ONCE, AND THEN MATE THEM AGAIN, FOLLOWING THE PROCEDURES ABOVE FROM THE BEGINNING.

UN-MATING METHOD

PLEASE UN-MATE THE CONNECTOR BY HAND

- (1) UN-MATE THE CONNECTORS PARALLEL TO EACH OTHER. HOWEVER, IF THE CONNECTORS HAVE HIGH PIN COUNTS OR THINNER FPC AND STIFFENER, IT BECOMES MORE DIFFICULT TO DO SO.

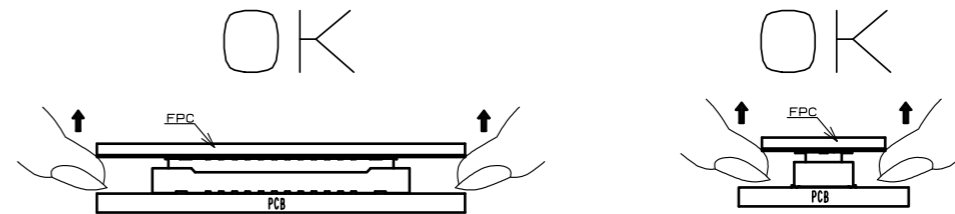

- (2) IF THE CONNECTOR CANNOT BE UN-MATED PARALLEL IT CAN BE REMOVED DIAGONALLY FROM THE PITCH DIRECTION. BE CAREFUL TO DO SO SINCE THIS ACTION APPLIES STRESS ON THE CONTACT.

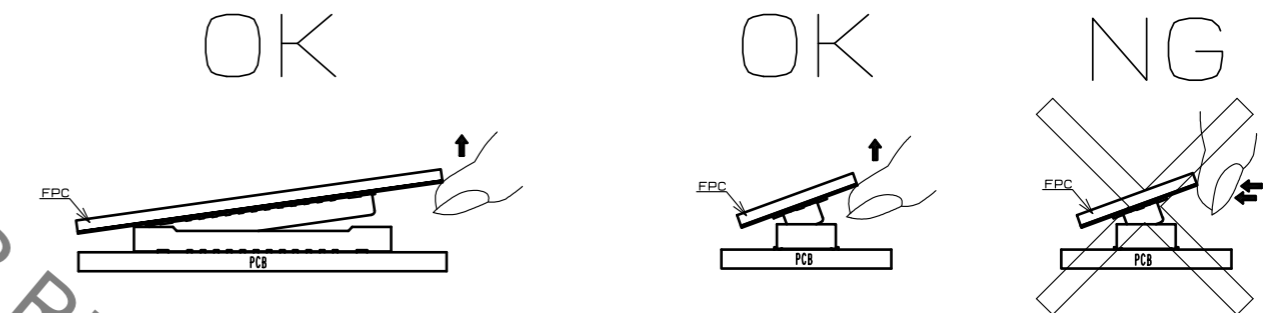

- (3) IF THE FPC IS NOT RIGID, THE CONNECTOR CAN BE BROKEN. PLEASE CHECK THE ACTION OF THE FPC TO BE USED REPEATEDLY AT THE TIME OF TRIAL PRODUCTION. BE CAREFUL TO UN-MATE THEM FROM THE PITCH DIRECTION, PULLING IT FROM THE CORNER CAN ALSO RISK TO PUTTING STRESS ON CONTACTS.

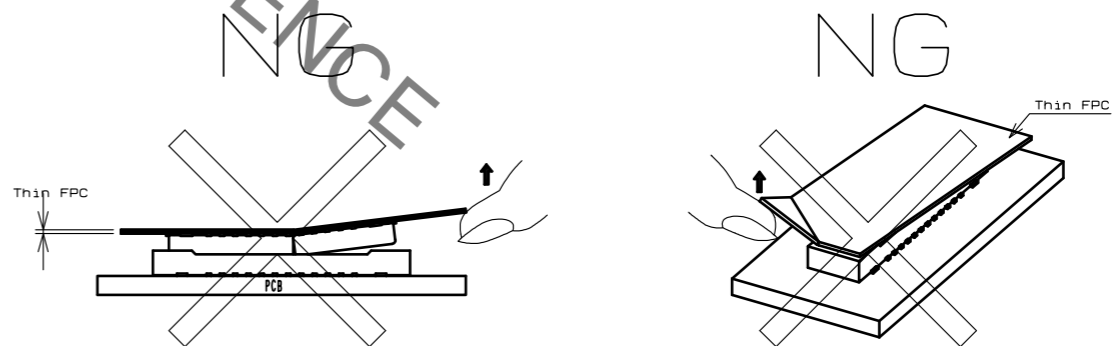

<b>HRS</b>	DRAWING NO.	EDC-378955-51-03	4/4
	PART NO.	BM46B-12DS-0.35V(51)	
	CODE NO.	CL0673-7054-0-51	
	△		