

Aug.1.2021 Copyright 2021 HIROSE ELECTRIC CO., LTD. All Rights Reserved.
In case of consideration for using Automotive equipment / device which demand high reliability, kindly contact our sales window correspondents.

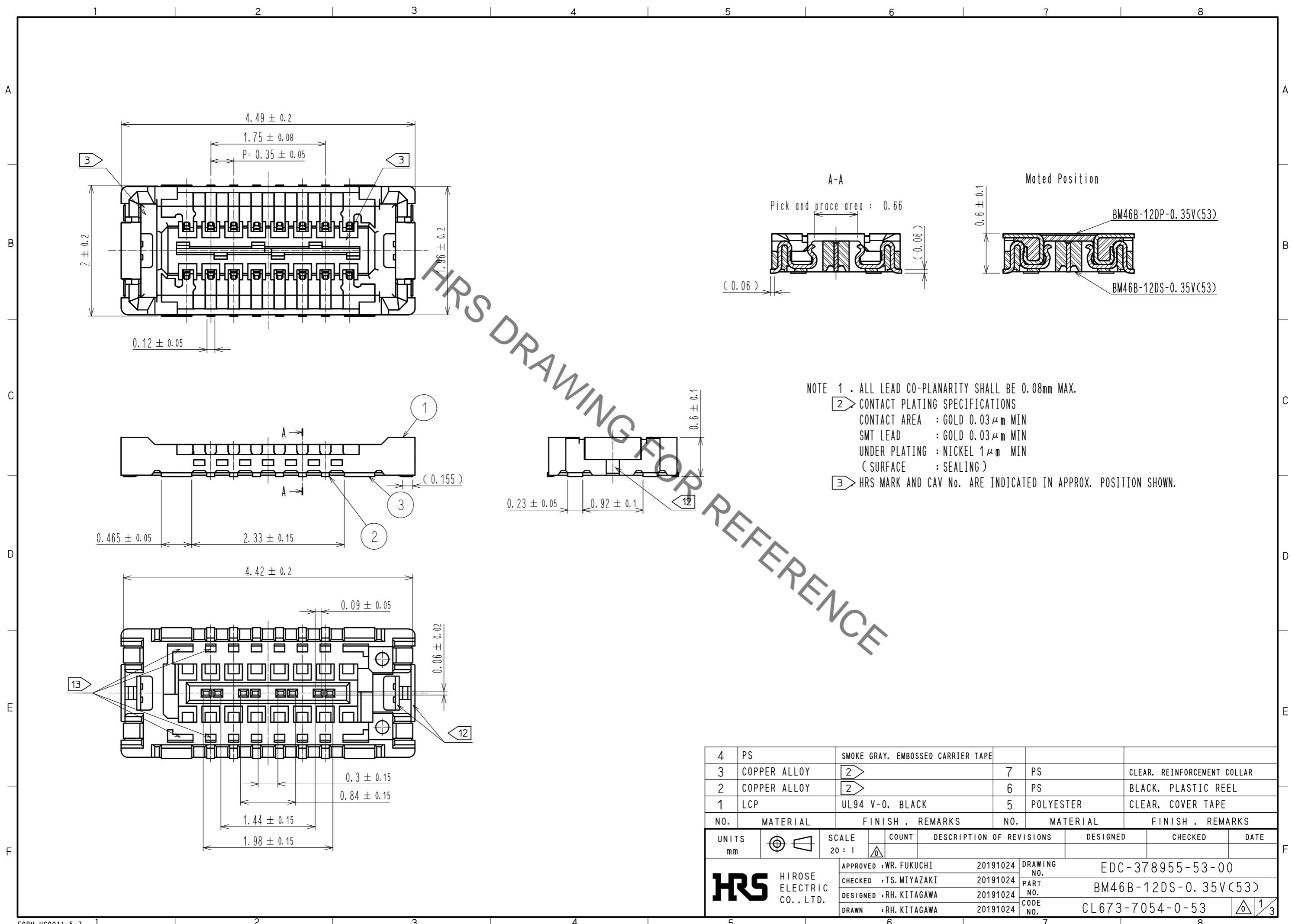

HRS DRAWING FOR REFERENCE

- NOTE 1 . ALL LEAD CO-PLANARITY SHALL BE 0.08mm MAX.
 2 CONTACT PLATING SPECIFICATIONS
 CONTACT AREA : GOLD $0.03 \mu\text{m}$ MIN
 SMT LEAD : GOLD $0.03 \mu\text{m}$ MIN
 UNDER PLATING : NICKEL $1 \mu\text{m}$ MIN
 (SURFACE : SEALING)
 3 HRS MARK AND CAV No. ARE INDICATED IN APPROX. POSITION SHOWN.

4	PS	SMOKE GRAY, EMBOSSED CARRIER TAPE					
3	COPPER ALLOY	2	7	PS	CLEAR, REINFORCEMENT COLLAR		
2	COPPER ALLOY	2	6	PS	BLACK, PLASTIC REEL		
1	LCP	UL94 V-0, BLACK	5	POLYESTER	CLEAR, COVER TAPE		
NO.	MATERIAL	FINISH . REMARKS	NO.	MATERIAL	FINISH . REMARKS		
UNITS		SCALE	COUNT	DESCRIPTION OF REVISIONS	DESIGNED	CHECKED	DATE
mm		20 : 1					
APPROVED : WR. FUKUCHI			20191024	DRAWING NO. EDC-378955-53-00			
CHECKED : TS. MIYAZAKI			20191024	PART NO. BM46B-12DS-0.35V(53)			
DESIGNED : RH. KITAGAWA			20191024	CODE NO. CL673-7054-0-53			
DRAWN : RH. KITAGAWA			20191024	1/3			

Aug.1.2021 Copyright 2021 HIROSE ELECTRIC CO., LTD. All Rights Reserved.
In case of consideration for using Automotive equipment / device which demand high reliability, kindly contact our sales window correspondents.

RECOMMENDED PCB LAYOUT (10:1)

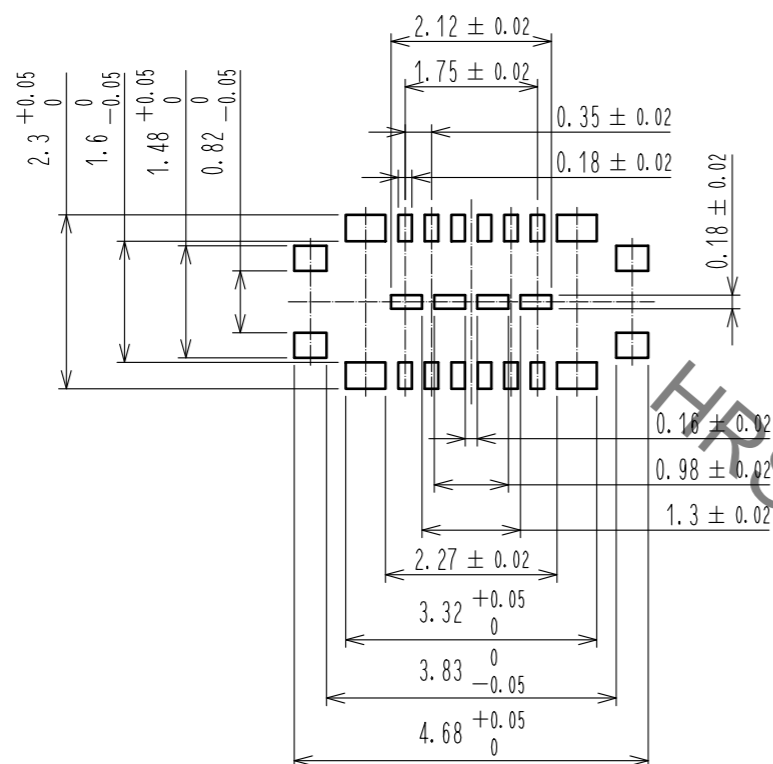

RECOMMENDED METAL MASK DIMENSIONS (10:1)
METAL MASK THICKNESS : 80 μm

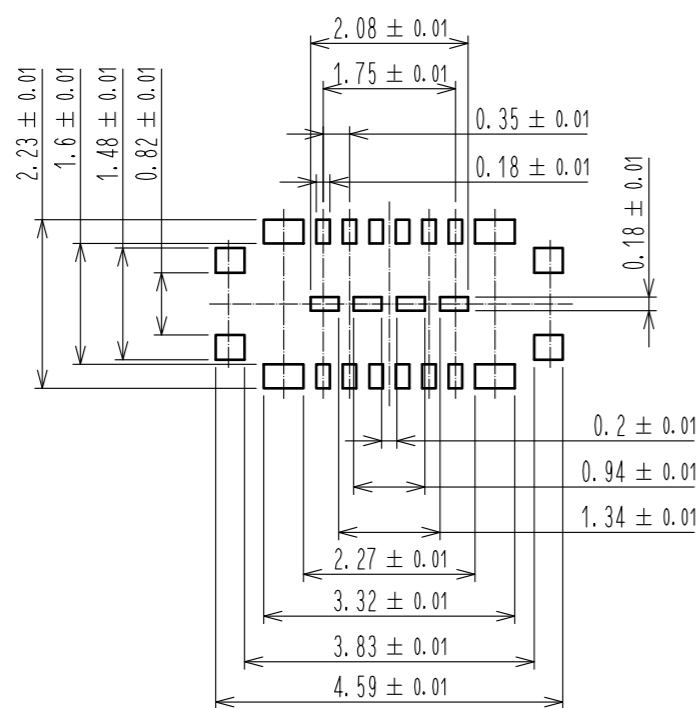

4 RECOMMENDED REFLOW TEMPERATURE PROFILE USING LEAD-FREE SOLDER PASTE.

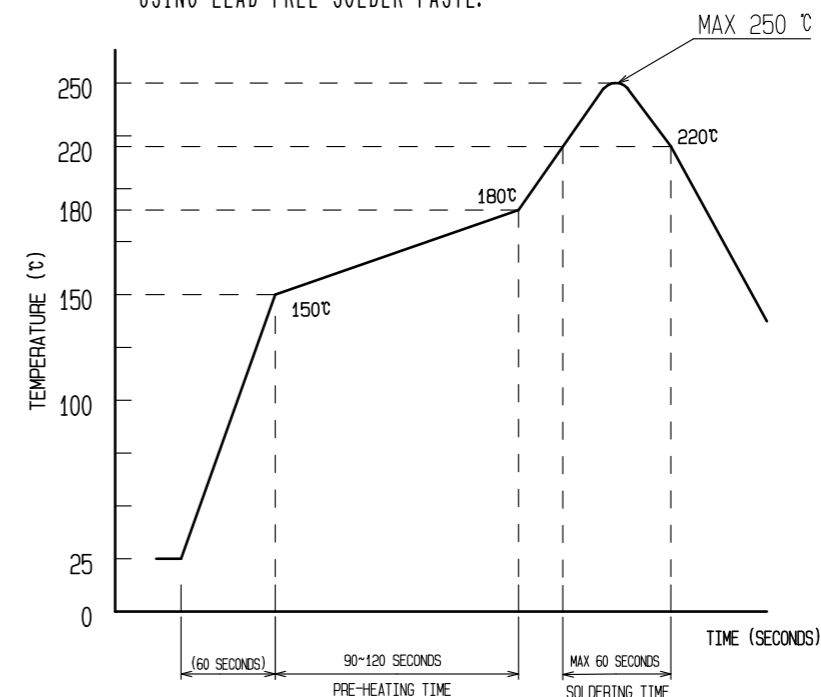

REFLOW METHOD: IR REFLOW
 NUMBER OF REFLOW CYCLES: 2 CYCLES MAX.
 1) REFLOW TIME
 DURATION ABOVE 220°C, 60 SEC MAX.
 (PEAK TEMPERATURE: 250°C MAX)
 2) PRE-HEAT TIME
 PRE-HEAT TEMPERATURE(MIN): 150°C
 PRE-HEAT TEMPERATURE(MAX): 180°C
 PRE-HEAT TIME: 90-120 SEC.

- 4 THIS TEMPERATURE PROFILE IS PER THE CONDITIONS SHOWN ABOVE. ADDITIONAL FACTORS, SUCH AS SOLDER PASTE TYPE, PCB SIZE AND OTHER MOUNTED COMPONENTS COULD AFFECT THE PROFILE, THEREFORE, A THOROUGH EVALUATION OF MOUNTING CONDITION IS REQUIRED PRIOR TO PRODUCTION. TEMPERATURE IS MEASURED AT CONTACT LEAD.
5. PLEASE CONTACT US IN CASE YOU WILL MAKE DIFFERENT SETTINGS FROM OUR RECOMMENDATION.
 6. THIS PRODUCT SATISFIES HALOGEN FREE REQUIREMENTS DEFINED AS 900ppm MAXIMUM CHLORINE, 900ppm MAXIMUM BROMINE, AND 1500ppm MAXIMUM TOTAL OF CHLORINE AND BROMINE.
 7. THIS PRODUCT COMPLY WITH RoHS.

HRS	DRAWING NO.	EDC-378955-53-00
	PART NO.	BM46B-12DS-0.35V(53)
	CODE NO.	CL673-7054-0-53

2/3

Aug.1.2021 Copyright 2021 HIROSE ELECTRIC CO., LTD. All Rights Reserved.
 In case of consideration for using Automotive equipment / device which demand high reliability, kindly contact our sales window correspondents.

EMBOSED CARRIER TAPE PACKAGING (5:1)

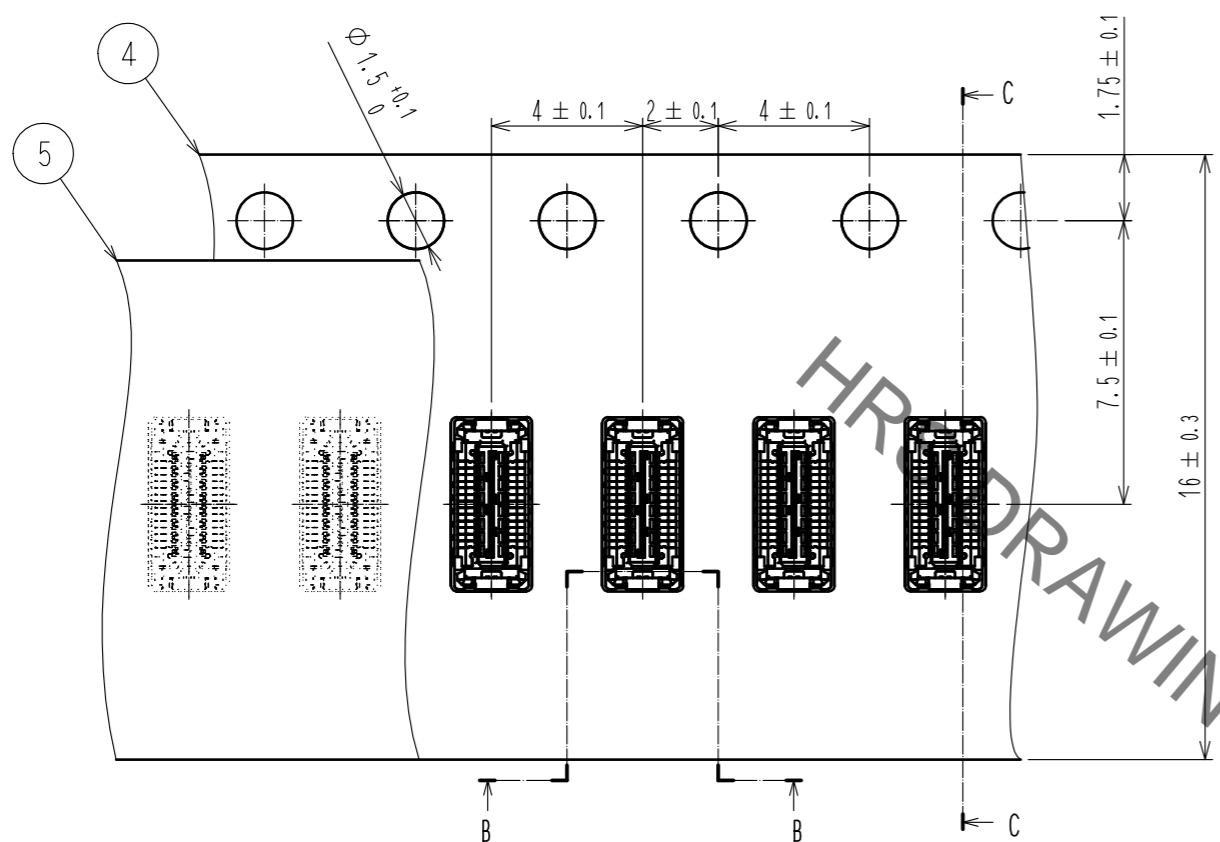

C-C (5:1)

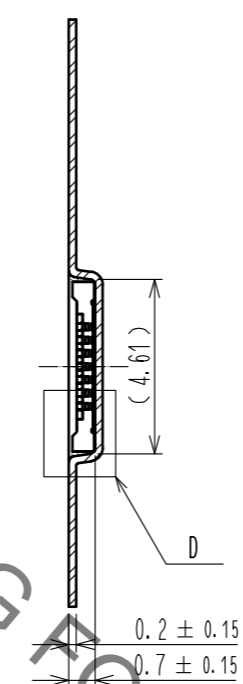

STYLE AND DIMENSION OF REEL (FREE)

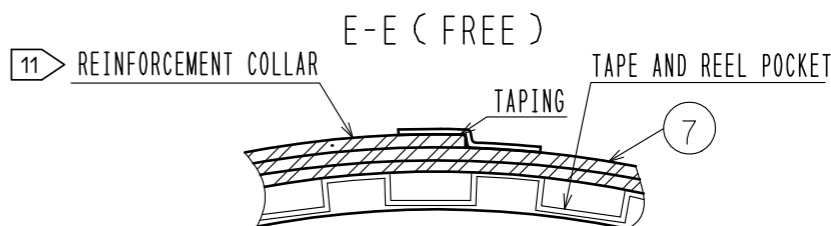
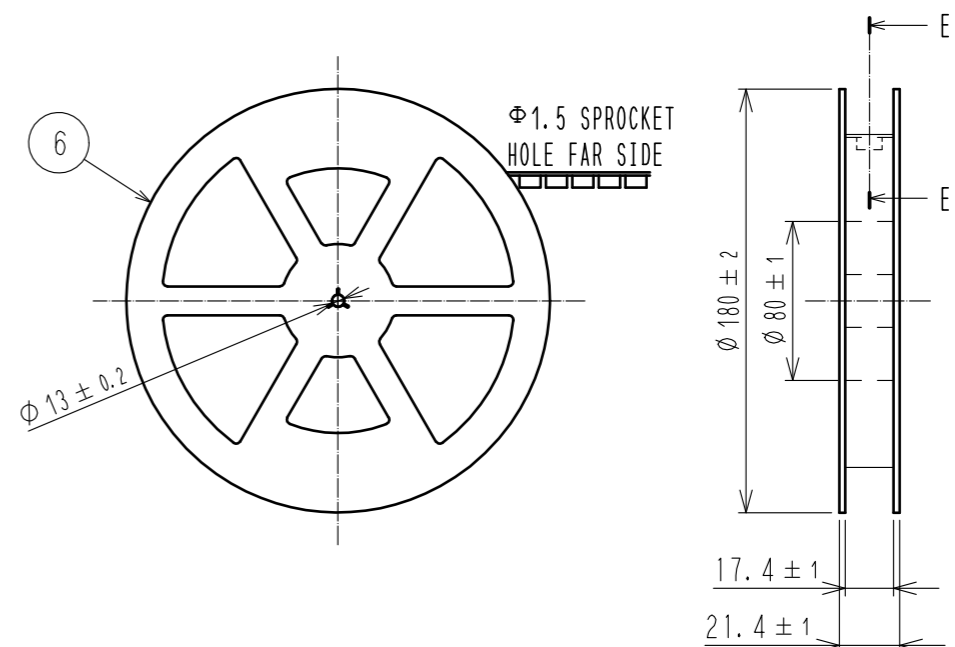

B-B (5:1)

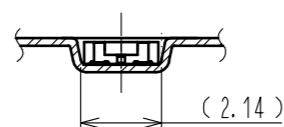

DIRECTION OF UNREELING

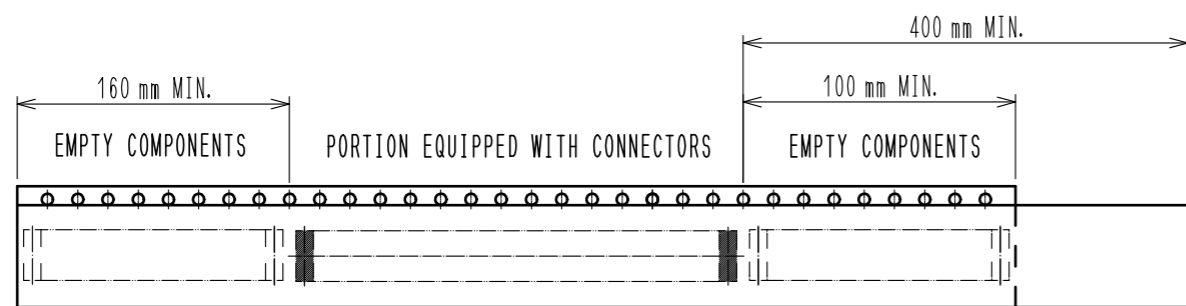
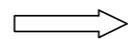

D (10:1)

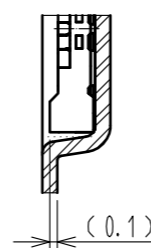

- 8 . PER REEL 1,000 CONNECTORS.
- 9 . THE DIMENSIONS IN PARENTHESES ARE FOR REFERENCE.
- 10 REFER TO IEC 60286-3 (PACKAGING OF COMPONENTS FOR AUTOMATIC HANDLING)
- 11 AFTER PACKAGING, ROLL 2 METERS OF THE REINFORCEMENT COLLAR TO OUTER CIRCUMFERENCE OF TAPE AND REEL POCKET, AND TAPE DOWN AT THE END THE COLLAR.
- 12 METAL OR RESIN IS ACCEPTABLE FOR THIS AREA.
- 13 NO GOLD PLATING IS ACCEPTABLE FOR THIS AREA.

HRS	DRAWING NO.	EDC-378955-53-00
	PART NO.	BM46B-12DS-0.35V(53)
	CODE NO.	CL673-7054-0-53
		\triangle 3/3