

SMA Reverse Coaxial Connector Up to 26.5GHz

SMA(R) Series



■ Features

1. Excellent high-frequency performance

Equivalent to perform same characteristics as Hirose HRM series which is Japan's first SMA. Conforming to FCC Standard (Part15 47 CFR 15.203*)

2. Small size / Light weight / Robust

3. Wide variation

Various SMA and FL conversion Adapters are available. Assembly with FL series is available.

■ Applications

Wi-Fi equipment, Gaming machine, Measurement instrument and other equipment's inter connection which need special interface.

■ Product Specifications

Ratings	Nominal characteristic impedance	50Ω	Operating Temperature Range	-55°C to +125°C
	Rated frequency	0 to 26.5GHz	Storage Temperature Range	95% RH or less

Items	Specifications		Conditions			
1. Contact resistance	SMA (R) -300-126B	HRMJ-SMA (R) P	Measured at less than 100mA DC			
	Center : Less than 6mΩ	Center : Less than 8mΩ				
	External : Less than 6mΩ	External : Less than 8mΩ				
2. Withstanding voltage	No flashover or breakdown		1000V AC for 1 minute			
3. Insulation resistance	5000MΩ min.		Measured at 500V DC			
4. Moisture resistance of temperature/humidity cycle	SMA (R) -300-126B	HRMJ-SMA (R) P	Left for 10 cycles (240 hours) in an environment with the temperature ranging from +25 to +65°C and the humidity ranging from 90 to 98%.			
	Insulation resistance : More than 100MΩ (in a high humidity environment) Insulation resistance : More than 5000MΩ (in a dry environment)	Insulation resistance : More than 100MΩ (in a high humidity environment) Insulation resistance : More than 1000MΩ (in a dry environment)				
5. Temperature cycle	No broken, cracked or loose parts		Temperature : 5 cycles for a series of time periods : -65°C for 30 minutes → +125°C for 30 minutes			
6. Salt spray	SMA (R) -300-126B	HRMJ-SMA (R) P	Continuous 48 hour in 5% salt water solution			
	VSWR : Less than 1.3	VSWR : Less than 1.4			0 to 3GHz	0 to 26.5GHz
	VSWR : Less than 1.5				3GHz to 6GHz	
7. Mating Cycles	SMA (R) -300-126B	HRMJ-SMA (R) P	SMA (R) -300-126B	HRMJ-SMA (R) P		
	Center : Less than 8mΩ External : Less than 8mΩ	Center : Less than 12mΩ External : Less than 12mΩ	500 cycles	1000 cycles		
8. V.S.W.R.	SMA (R) -300-126B	HRMJ-SMA (R) P	SMA (R) -300-126B	HRMJ-SMA (R) P		
	VSWR : Less than 1.3	VSWR : Less than 1.25	0 to 3GHz	0 to 12.4GHz		
	VSWR : Less than 1.5	VSWR : Less than 1.3	3GHz to 6GHz	12.4GHz to 18GHz		
		VSWR : Less than 1.4	—	18GHz to 26.5GHz		

■ Materials / Finish

Part	Materials	Finish
Shell	Receptacle	Brass
	Plug, Shell	Stainless steel
Contact	Male contact	Brass
	Female contact	Beryllium copper
Insulator	PTFE (resin)	—

High-frequency characteristic

Connector combination for the measurement.

(Straight adapter SMA Plug - PR-SMA Plug and SMA Jack - RP-SMA Jack)

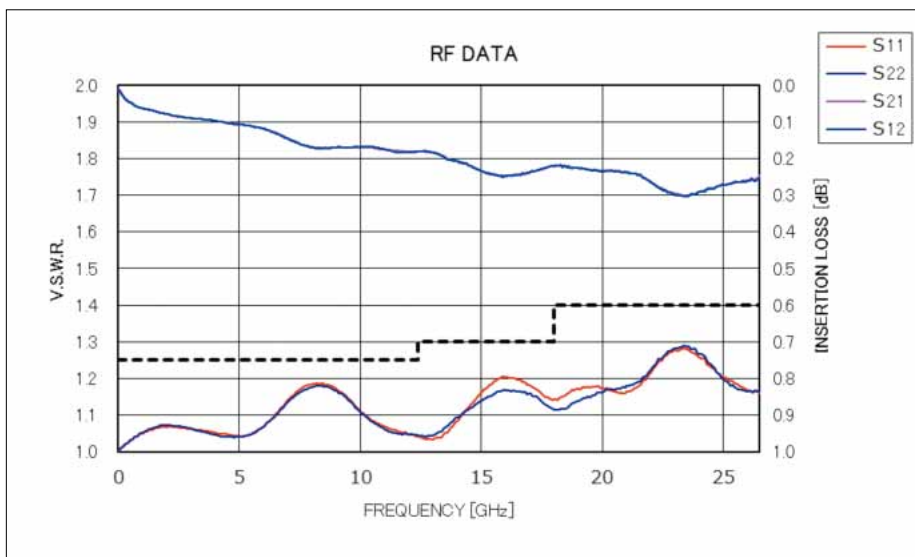
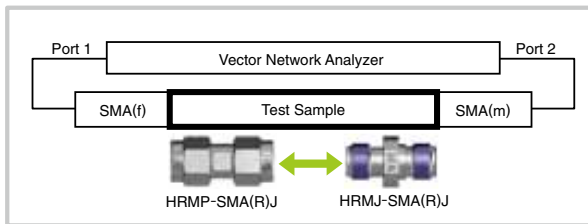

Dimensions

Plug openings

Jack openings

Shape 1

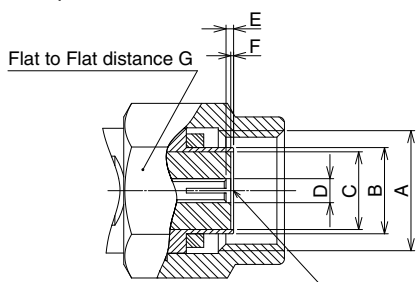

Insert $\phi 0.910$ pin.
Extraction force shall be 1.5N or more.

Symbol	Dimensions	
	Shape1	Shape2
A	1/4-36UNS-2B	
B	$\phi 4.56$	
C	$\phi 4.11$	
D	$\phi 1.27$	
E	0.13	0.58
F	0.08	
G	8	

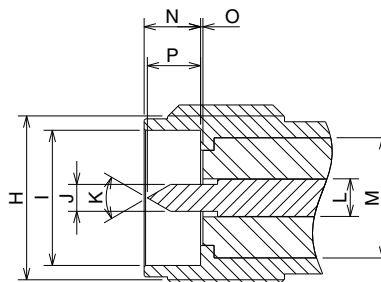

Symbol	Dimensions
H	1/4-36UNS-2A
I	$\phi 4.62$
J	$\phi 0.92$
K	60°
L	$\phi 1.27$
M	$\phi 4.11$
N	1.93
O	0.08
P	1.8

Shape 2

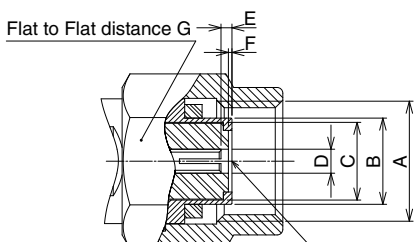

Insert $\phi 0.910$ pin.
Extraction force shall be 1.5N or more.

■ Ultra - fine Coaxial Cable (6GHz)

● Straight plug

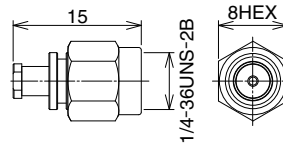

Part No.	HRS No.	Applicable Cable
SMA(R)-200-040PBN	323-0925-0	φ0.81
SMA(R)-200-066PBN	323-0930-0	φ1.13, φ1.32
SMA(R)-200-088PBN	323-0905-3	φ1.37, φ1.48

● Straight jack

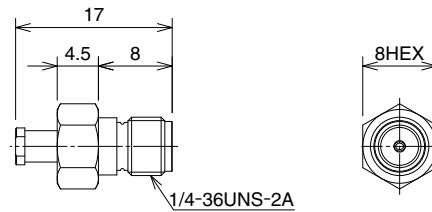

Part No.	HRS No.	Applicable Cable
SMA(R)-200-040JBN	323-0926-3	φ0.81
SMA(R)-200-066JBN	323-0931-3	φ1.13, φ1.32
SMA(R)-200-088JBN	323-0904-0	φ1.37, φ1.48

● Panel jack (4 hole type)



Part No.	HRS No.	Applicable Cable
SMA(R)-200-040PJ4BN	323-0928-9	φ0.81
SMA(R)-200-066PJ4BN	323-0932-6	φ1.13, φ1.32
SMA(R)-200-088PJ4BN	323-0934-1	φ1.37, φ1.48

● Panel jack (2 hole type)

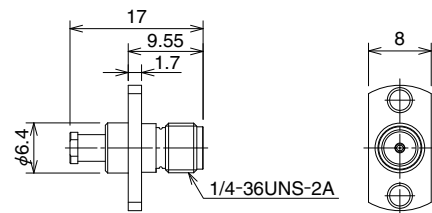

Part No.	HRS No.	Applicable Cable
SMA(R)-200-040PJ2BN	323-0929-1	φ0.81
SMA(R)-200-066PJ2BN	323-0933-9	φ1.13, φ1.32
SMA(R)-200-088PJ2BN	323-0935-4	φ1.37, φ1.48

■ Ultra - fine Coaxial Cable (6GHz)

● Panel jack (Bulkhead type)

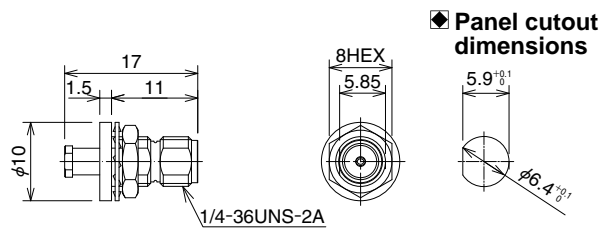

Part No.	HRS No.	Applicable Cable
SMA(R)-200-040BPJBN	323-0927-6	φ0.81
SMA(R)-200-066BPJBN	323-0902-5	φ1.13, φ1.32
SMA(R)-200-088BPJBN	323-0901-2	φ1.37, φ1.48

● Panel jack (Bulkhead type / Waterproof)

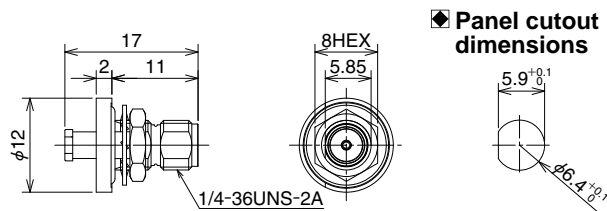

Part No.	HRS No.	Applicable Cable
SMA(R)-200-040WBPJBN	323-0947-3	φ0.81
SMA(R)-200-066WBPJBN	323-0948-6	φ1.13, φ1.32
SMA(R)-200-088WBPJBN	323-0949-9	φ1.37, φ1.48

■ Straight plug

● Flexible cable

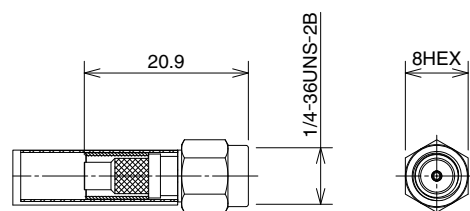

Part No.	HRS No.	Applicable Cable
SMA(R)-P-2.5DQS	323-0875-4	2.5D-HQ SUPER

Receptacles

● Right angle receptacle (THT mount type)

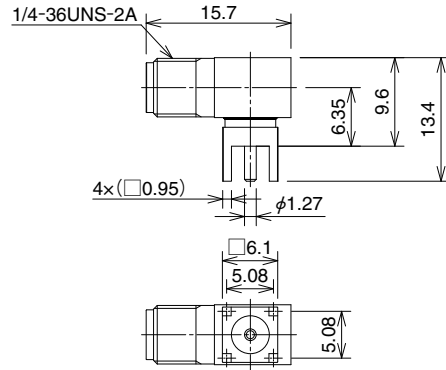
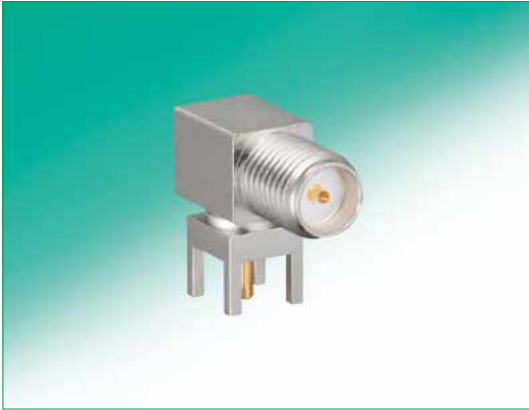

Part No.	HRS No.	Remark
SMA(R)-300-126B	323-0111-0	Shell : Brass

● Straight receptacle (Edge mount type)

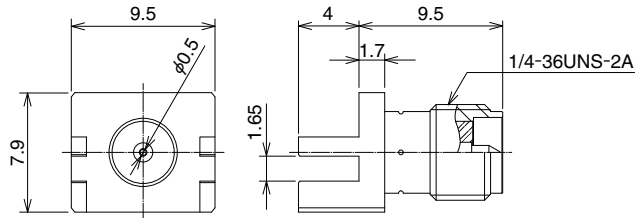
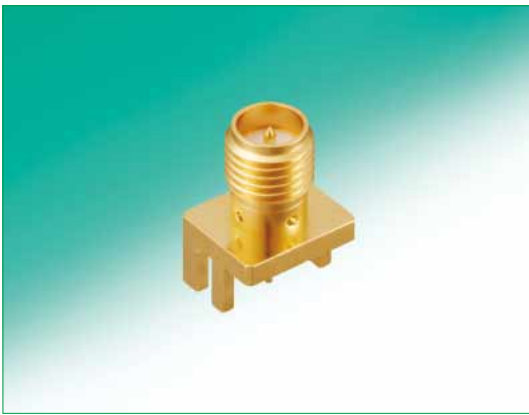

Part No.	HRS No.	Remark
SMA(R)-R-ELBG-1	323-0866-3	PCB Thickness 1.6mm

In-line Adapters

● Jack - Jack

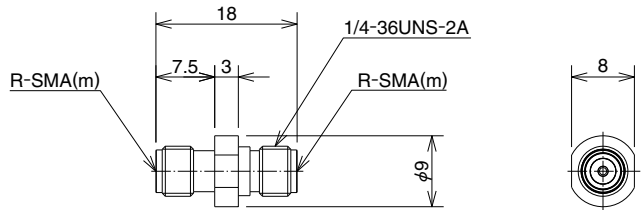

Part No.	HRS No.	Remark
SMA(R)-A-JJ	323-0124-0	Shell : Stainless steel

● Plug - Plug

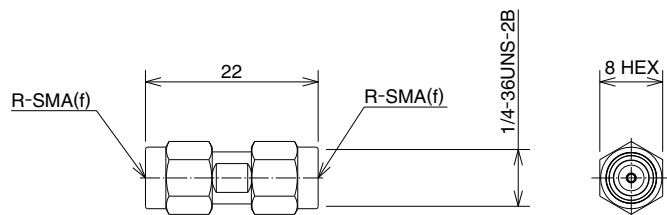

Part No.	HRS No.	Remark
SMA(R)-A-PP	323-0127-0	Shell : Stainless steel

SMA Conversion Adapters

● SMA jack - RP-SMA plug

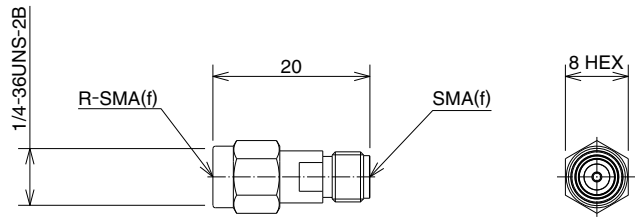

Part No.	HRS No.	Remark
HRMJ-SMA(R)P	323-0035-0	Shell : Stainless steel

● SMA plug - RP-SMA jack

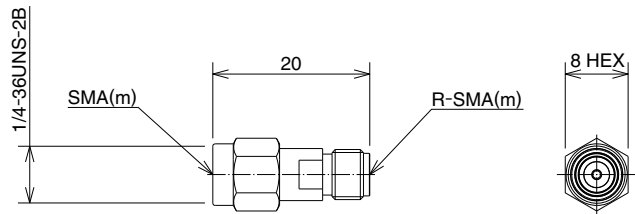

Part No.	HRS No.	Remark
HRMP-SMA(R)J	323-0036-0	Shell : Stainless steel

● SMA jack - RP-SMA jack

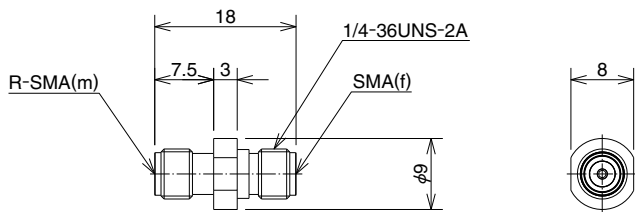

Part No.	HRS No.	Remark
HRMJ-SMA(R)J	323-0011-0	Shell : Stainless steel

● SMA plug - RP-SMA plug

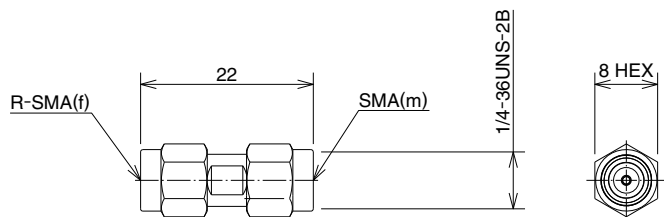

Part No.	HRS No.	Remark
HRMP-SMA(R)P	323-0009-0	Shell : Stainless steel

■ U.FL-J Conversion Adapters

● Panel adapter (Panel 4 hole)

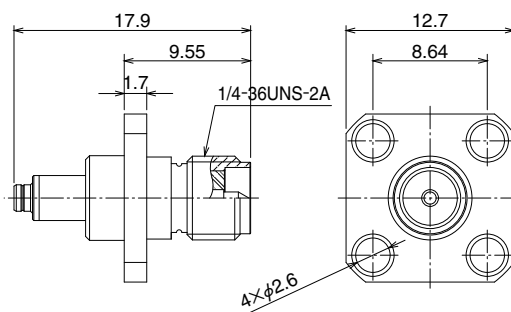

Part No.	HRS No.	Remark
SMA(R)J-U.FLJ-PA4	311-0466-5	Shell : Brass

● Panel adapter (Panel 2 hole)

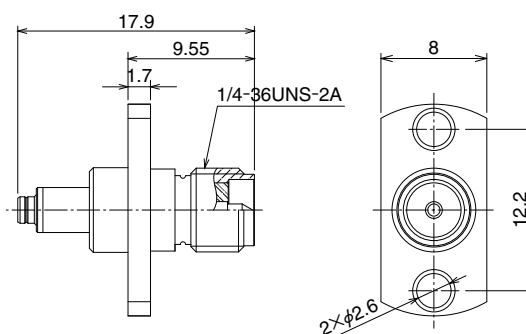

Part No.	HRS No.	Remark
SMA(R)J-U.FLJ-PA2	311-0468-0	Shell : Brass

● Panel adapter (Bulkhead type)

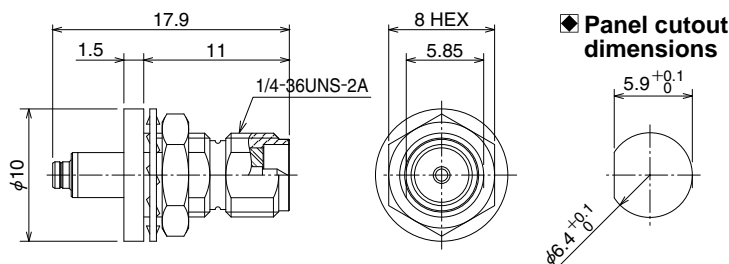

Part No.	HRS No.	Remark
SMA(R)J-U.FLJ-BPA-4	311-0464-0	Shell : Brass



HIROSE ELECTRIC CO.,LTD.

2-6-3,Nakagawa Chuoh,Tsuzuki-Ku,Yokohama-Shi 224-8540,JAPAN
 TEL: +81-45-620-3526 Fax: +81-45-591-3726
<http://www.hirose.com>
<http://www.hirose-connectors.com>